

WESTGATE HARDWOODS



PREMIUM MOULDINGS CATALOG

INTRODUCTION

Westgate Hardwoods is pleased to offer you the same quality products that have pleased our many satisfied customers since 1988. Please feel free to contact us about our many complimenting services or just drop by our showroom in Durham to see many of these catalog items on display.

Westgate Hardwoods, Inc. was established in 1988 and headquartered in Chico, California. We are a premier manufacturer of architectural millwork, offering custom cabinetry for kitchens to complete home or office packages. Additionally, we offer Coffered Ceilings, Custom Doors and Complete Entryways, Mantels, Mouldings, Millwork, Stairways and Parts, Wood Flooring and more. All of our products are manufactured by experienced craftsmen who take great pride in their work.

We can also offer curved and radius mouldings for window casings, archways, and curved walls.

Table of Contents

History	I
Base	1
Chair Rail	22
Crown	27
Casing	74
Miscellaneous	104
Planton	133
Rabbet	146
Stop	155
Stair	157
Bar Rail	164
Wainscot	167
Picture Index	175
Terms and Conditions	211

BASE

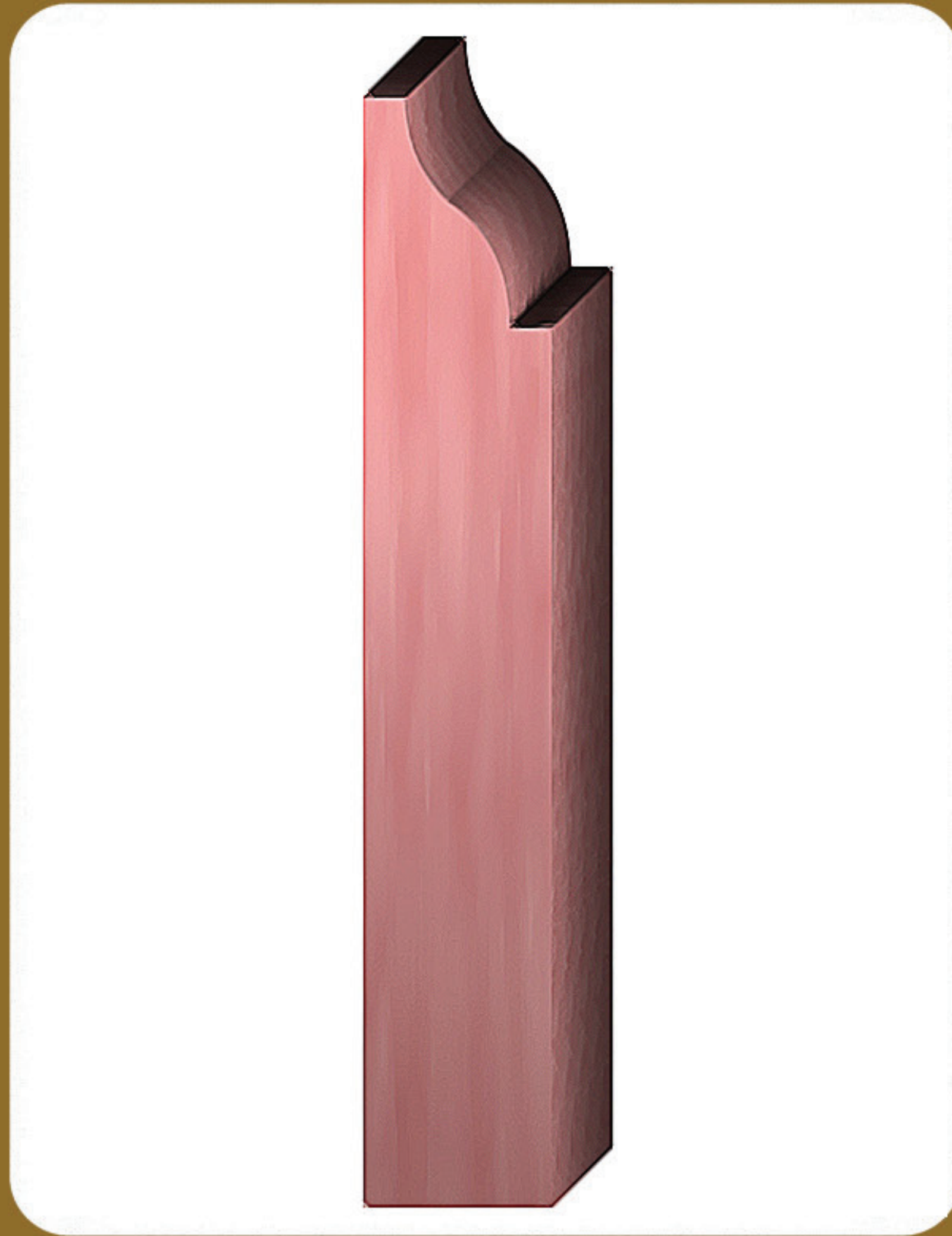

ID#	Page #	Dimension	ID#	Page #	Dimension
BA01	4	11/16 x 5-1/4	BA42	9	3/4 x 5-5/16
BA02	19	9/16 x 5-1/16	BA43	10	3/4 x 5-1/16
BA03	5	9/16 x 5	BA44	8	5/16 x 3-1/4
BA04	21	3/8 x 3-1/4	BA45	14	1/2 x 5-1/4
BA05	12	11/16 x 5-3/8	BA46	15	3/4 x 4-1/8
BA06	10	13/16 x 5-3/8	BA47	20	1/2 x 5
BA07	17	1 x 4-5/8	BA48	16	9/16 x 7-1/4
BA08	13	9/16 x 4-1/4	BA49	11	13/16 x 7-1/4
BA09	3	9/16 x 4-1/4	BA50	11	11/16 x 7-3/16
BA10	17	1-1/8 x 4-5/8	BA51	8	9/16 x 3-11/16
BA11	8	3/4 x 2	BA52	7	13/16 x 6
BA12	4	5/8 x 6-3/16	BA53	21	1/2 x 3-1/4
BA13	4	9/16 x 5-1/4	BA54	8	9/16 x 2-1/4
BA14	19	3/4 x 5-9/16	BA55	7	5/8 x 7
BA15	19	11/16 x 5-1/2	BA56	13	5/8 x 4-5/8
BA16	15	1 x 3-1/4	BA57	14	5/8 x 4-1/4
BA17	19	11/16 x 5-1/16	BA58	9	9/16 x 5-1/4
BA18	5	13/16 x 5-1/2	BA59	17	5/8 x 5-1/4
BA19	15	9/16 x 4-3/8	BA60	16	3/4 x 6-1/16
BA20	5	5/16 x 3-1/4	BA61	9	9/16 x 4-5/16
BA21	14	11/16 x 4-7/16	BA62	15	3/4 x 2-3/4
BA22	10	3/4 x 4-1/2	BA63	17	3/4 x 5-15/16
BA23	19	5/8 x 4-1/4	BA64	18	3/4 x 7-1/4
BA24	20	5/8 x 5-1/4	BA65	6	5/8 x 4
BA25	4	1/4 x 3-1/4	BA66	8	3/4 x 2-1/8
BA26	5	1/2 x 4	BA67	8	5/8 x 2-1/4
BA27	6	3/4 x 4	BA68	15	11/16 x 3-11/16
BA28	8	1/2 x 3	BA69	12	3/4 x 5-9/16
BA29	21	5/16 x 2-1/4	BA70	10	11/16 x 4-1/2
BA30	21	9/16 x 3-5/16	BA71	10	1-3/16 x 5
BA31	4	3/8 x 2-3/16	BA72	14	9/16 x 4-3/8
BA32	3	13/16 x 7-9/16	BA73	9	9/16 x 6-1/8
BA33	18	1 x 7-1/8	BA74	15	9/16 x 4-1/2
BA34	15	11/16 x 3-1/4	BA75	12	3/4 x 6
BA35	21	7/16 x 2-3/4	BA76	8	1/2 x 3-1/4
BA36	7	11/16 x 5-1/4	BA77	9	11/16 x 6
BA37	15	11/16 x 3-1/4	BA78	21	3/8 x 3-1/4
BA38	15	3/8 x 2-1/2	BA79	6	11/16 x 5
BA39	21	9/16 x 5-3/16	BA80	16	3/4 x 5-1/2
BA40	14	9/16 x 5-1/8	BA81	12	11/16 x 5-1/4
BA41	10	9/16 x 5-5/16	BA82	5	1/2 x 5-3/4

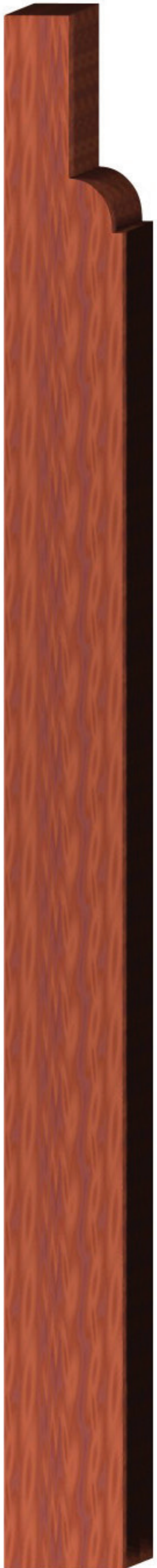

BA95
11/16 x 8-15/16

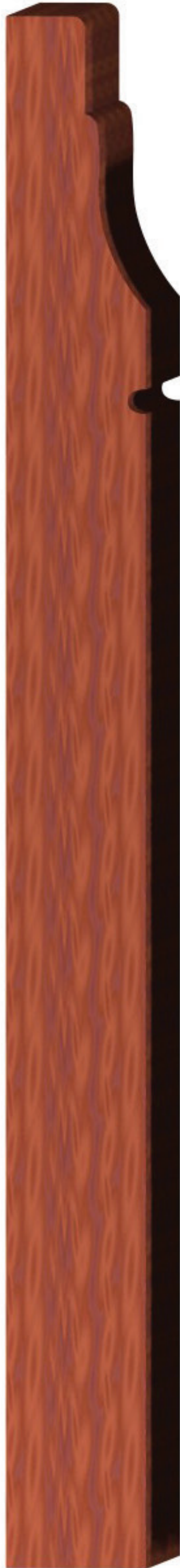

BA84
3/4 x 8



BA32
13/16 x 7-9/16

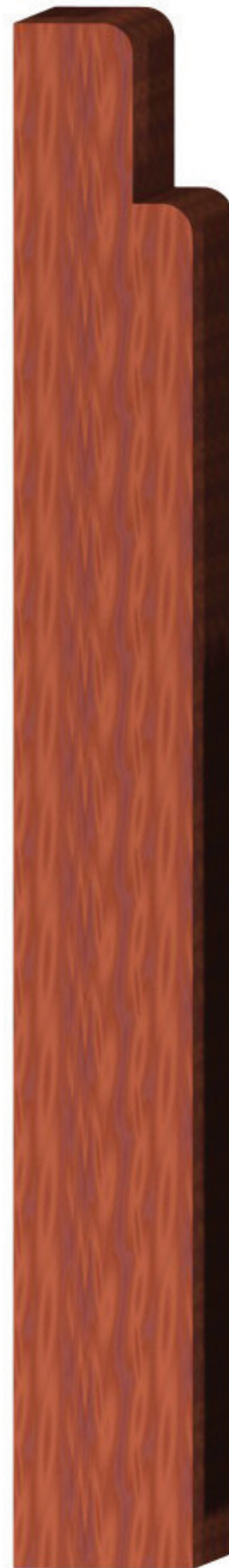

BA92
3/4 x 6-7/16



BA90
3/4 x 4-7/8



BA09
9/16 x 4-1/4

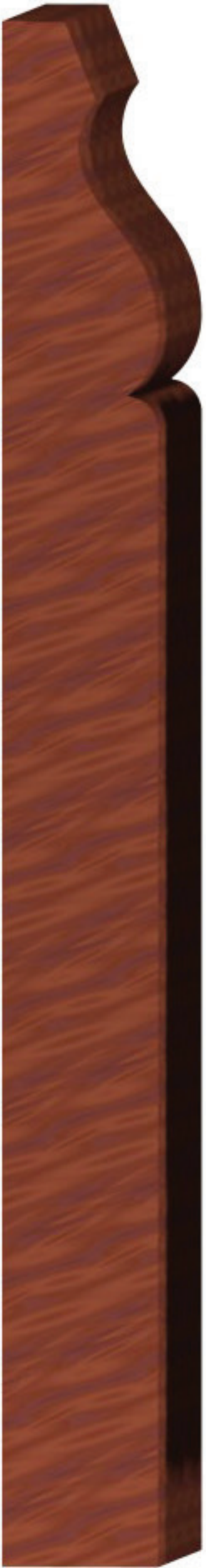

BA12
5/8 x 6-3/16



BA01
11/16 x 5-1/4



BA13
9/16 x 5-1/4



BA25
1/4 x 3-1/4



BA31
3/8 x 2-3/16



BA82
1/2 x 5-3/4



BA18
13/16 x 5-1/2



BA03
9/16 x 5

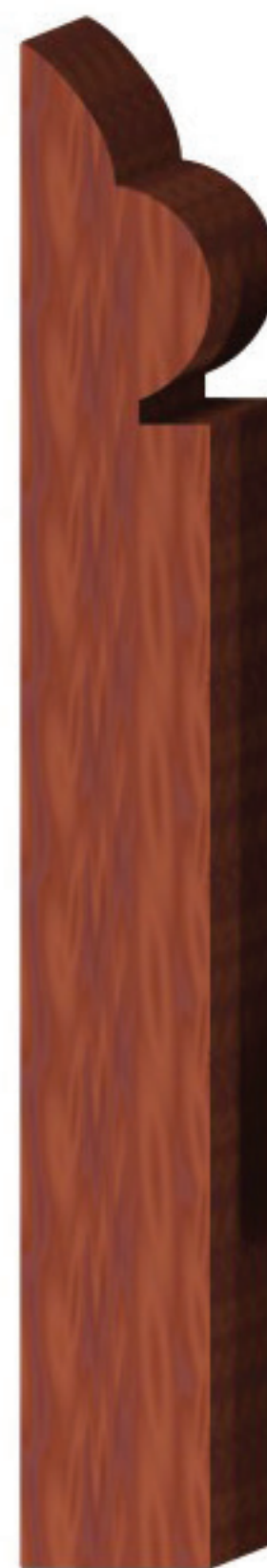

BA26
1/2 x 4



BA20
5/16 x 3-1/4



BA94
13/16 x 5-15/16



BA79
11/16 x 5



BA27
3/4 x 4

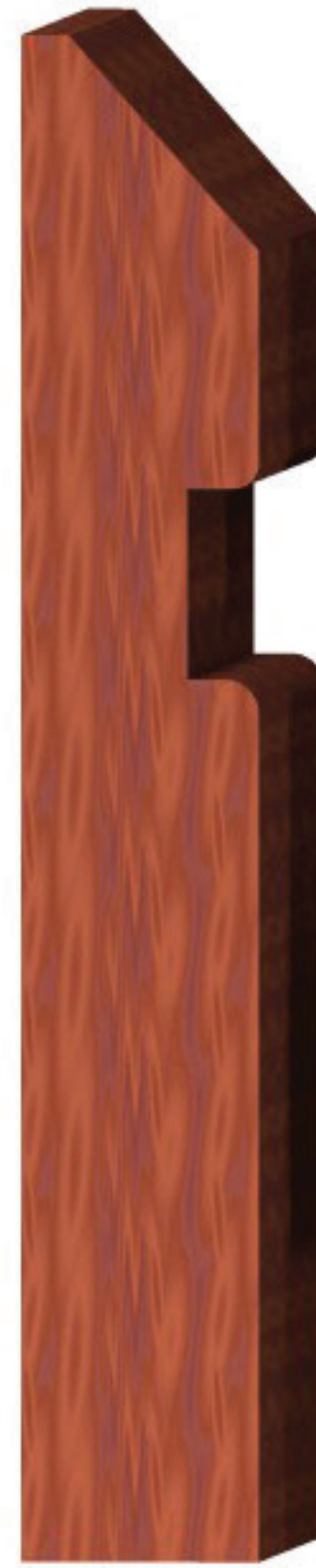

BA65
5/8 x 4



BA83
3/4 x 3-1/2

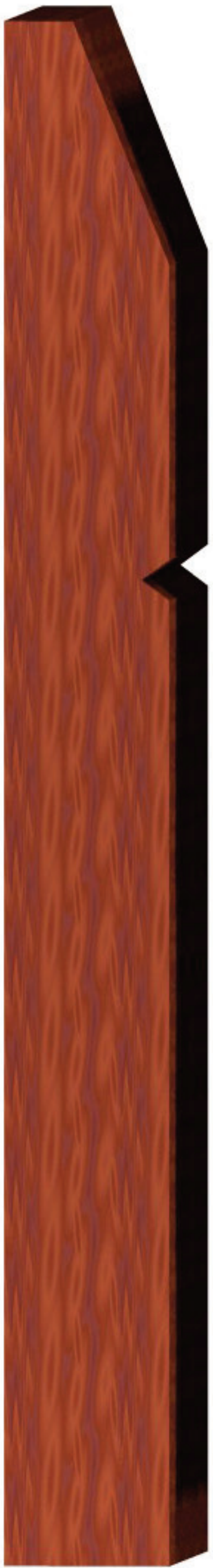

BA97
3/4 x 7



BA55
5/8 x 7



BA52
13/16 x 6



BA107
3/4 x 6

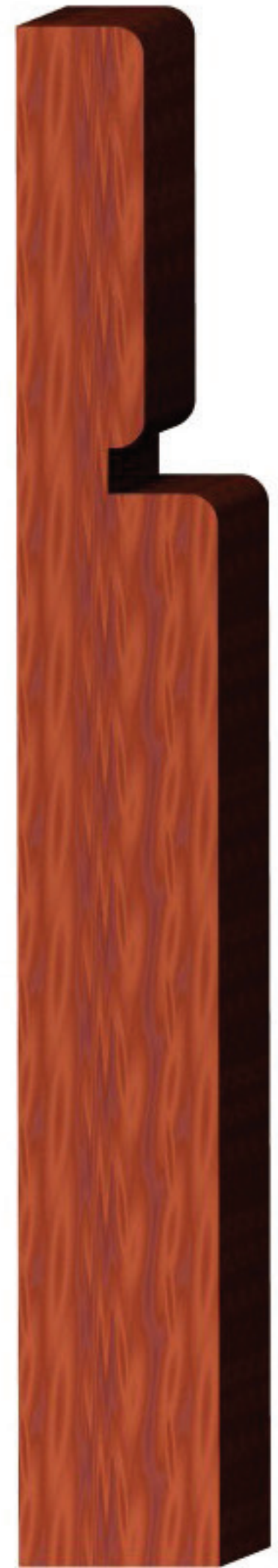

BA36
11/16 x 5-1/4



BA66
3/4 x 2-1/8



BA54
9/16 x 2-1/4



BA11
3/4 x 2



BA91
5/16 x 1-15/16



BA51
9/16 x 3-11/16



BA76
1/2 x 3-1/4



BA44
5/16 x 3-1/4



BA88
3/8 x 3



BA28
1/2 x 3



BA67
5/8 x 2-1/4



BA73
9/16 x 6-1/8



BA77
11/16 x 6



BA42
3/4 x 5-5/16



BA58
9/16 x 5-1/4



BA61
9/16 x 4-5/16



BA06
13/16 x 5-3/8



BA41
9/16 x 5-5/16



BA43
3/4 x 5-1/16

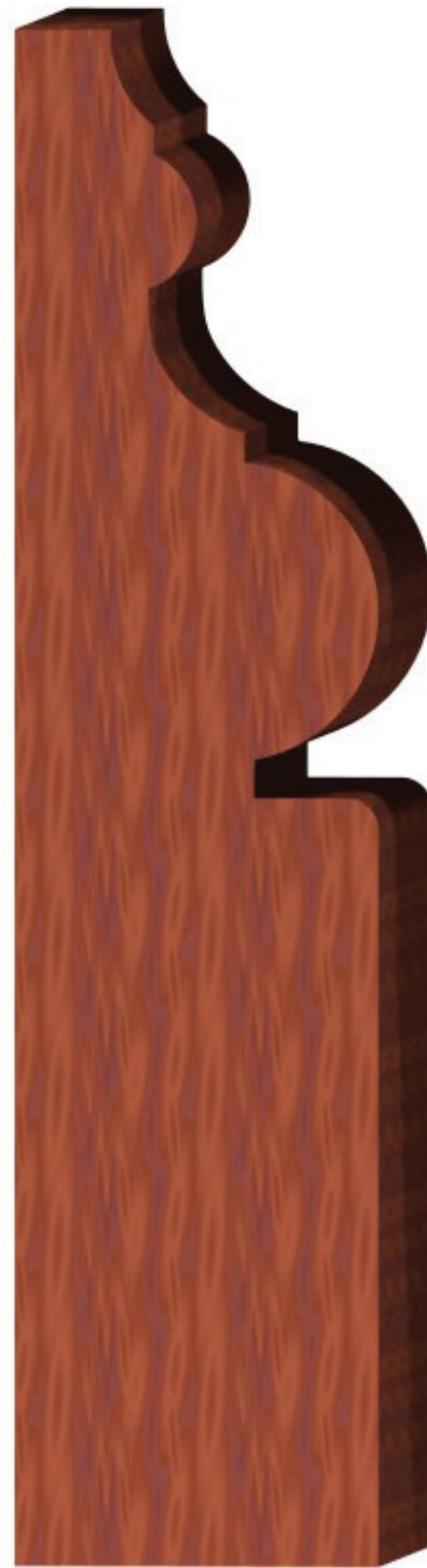

BA71
1-3/16 x 5

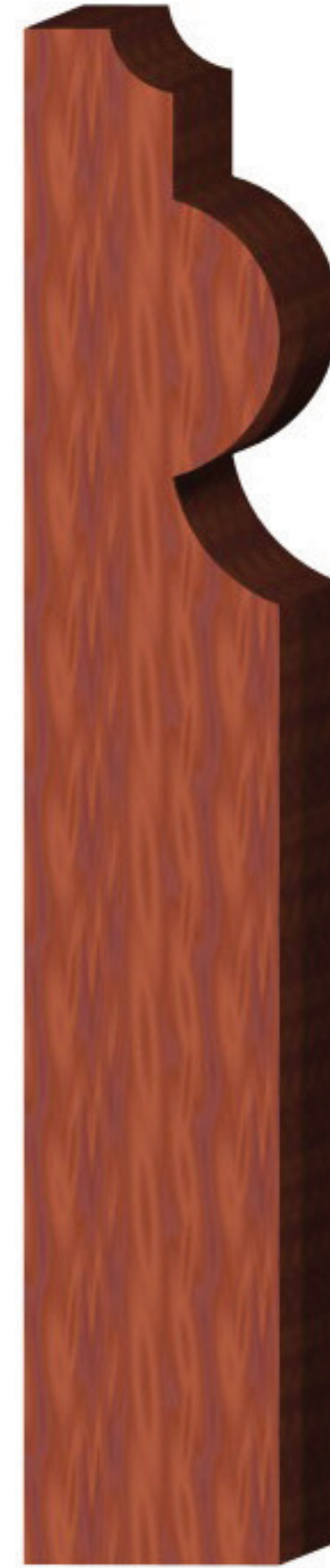

BA22
3/4 x 4-1/2



BA70
11/16 X 4-1/2



BA99
11/16 x 8

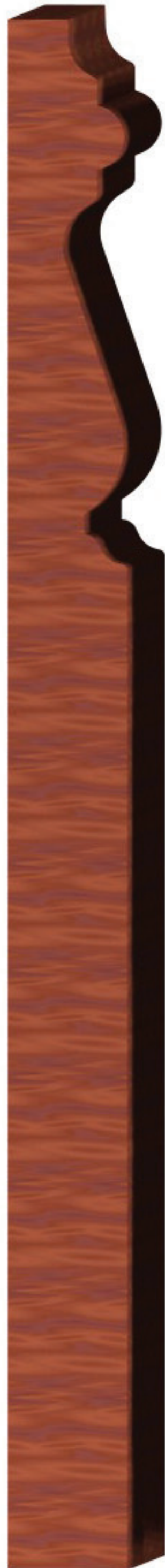

BA105
9/16 x 7-1/4



BA50
11/16 x 7-3/16

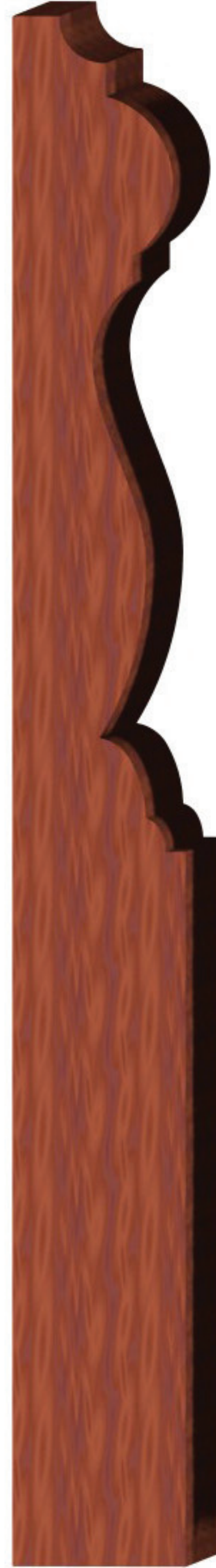

BA49
13/16 x 7-1/4



BA86
5/8 x 7-1/4



BA75
3/4 x 6

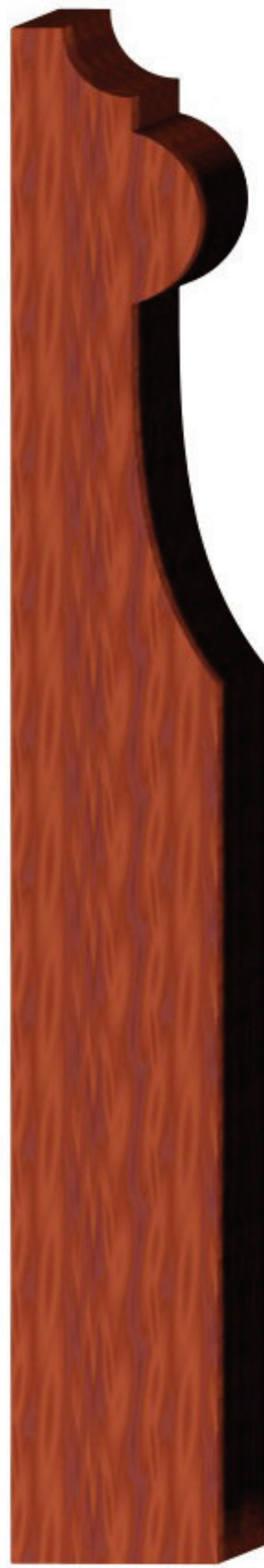

BA69
3/4 x 5-9/16



BA05
11/16 x 5-3/8

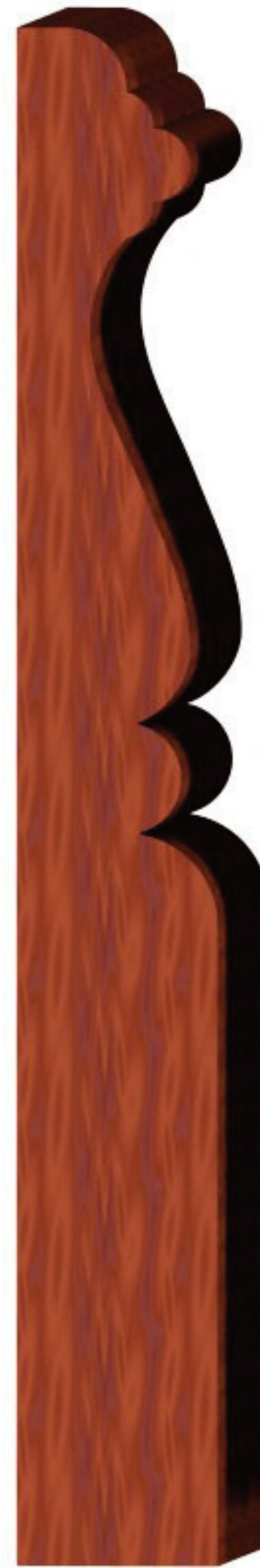

BA81
11/16 x 5-1/4



BA102
11/16 x 5-1/4



BA89
7/8 x 5-7/16



BA56
5/8 x 4-5/8



BA87
11/16 x 5-1/4



BA08
9/16 x 4-1/4

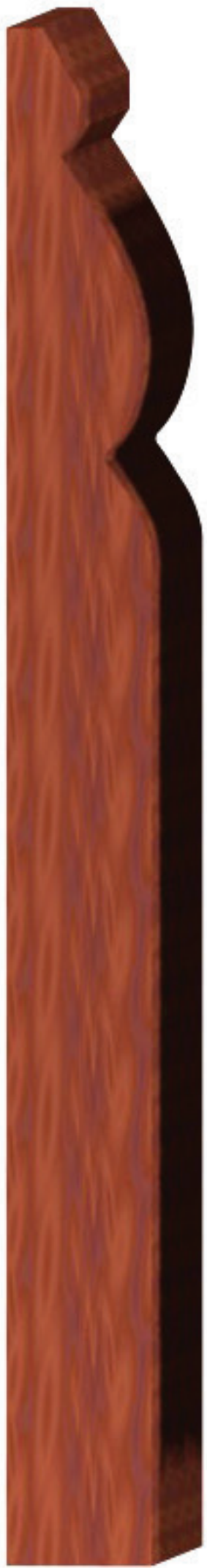

BA45
1/2 x 5-1/4



BA40
9/16 x 5-1/8



BA72
9/16 x 4-3/8

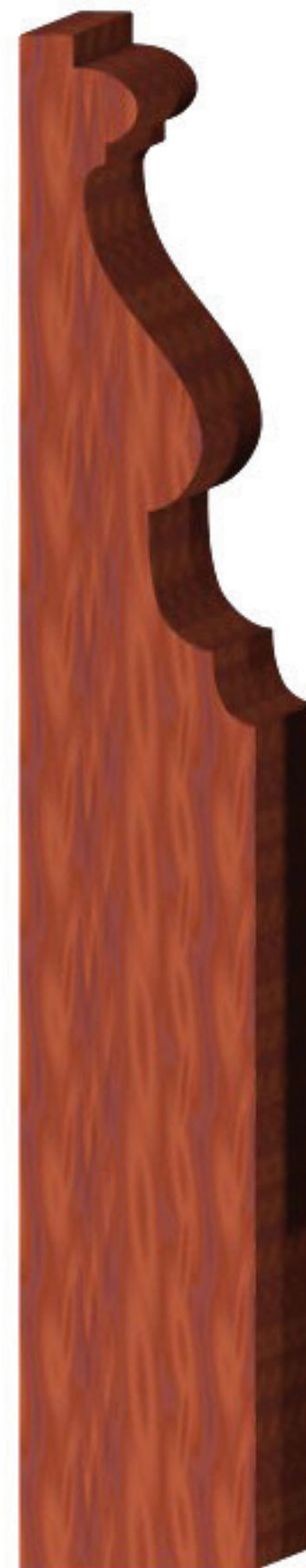

BA21
11/16 x 4-7/16



BA57
5/8 x 4-1/4

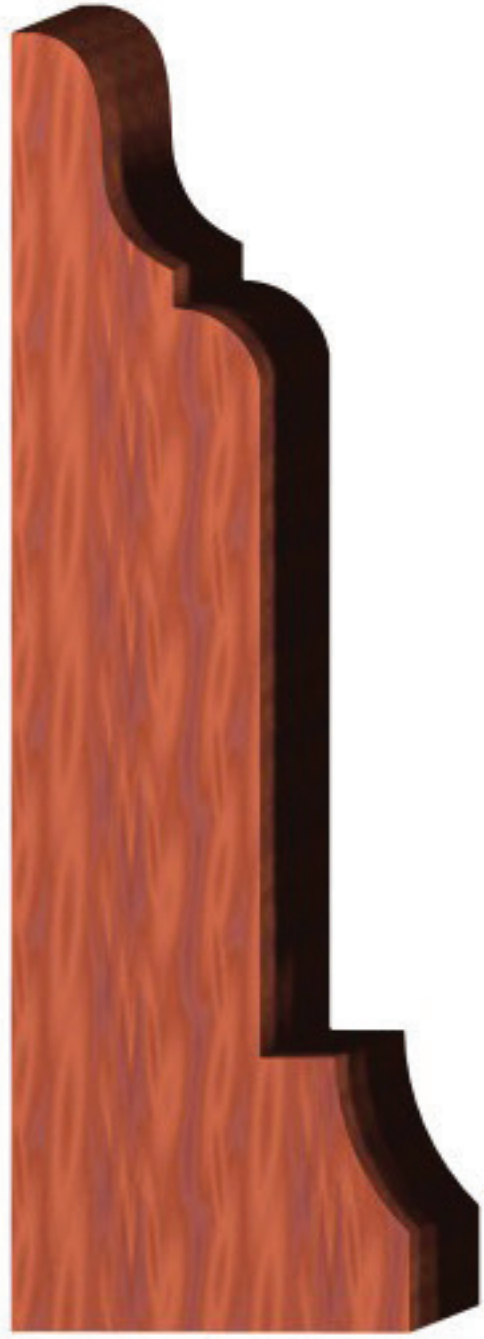

BA16
1 x 3-1/4



BA37
11/16 x 3-1/4



BA34
11/16 x 3



BA62
3/4 x 2-3/4



BA38
3/8 x 2-1/2



BA74
9/16 x 4-1/2



BA19
9/16 x 4-3/8



BA46
3/4 x 4-1/8

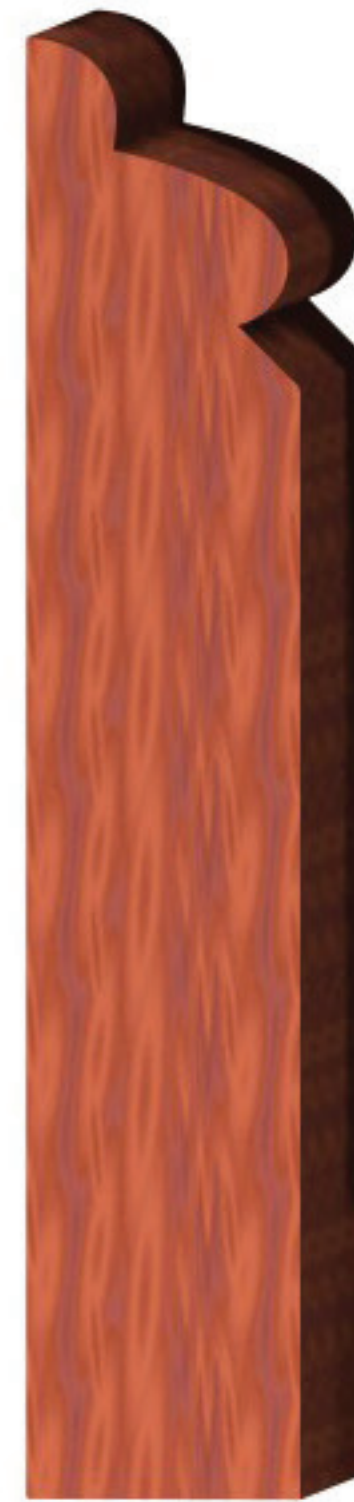

BA68
11/16 x 3-11/16



BA106
9/16 x 1-1/2

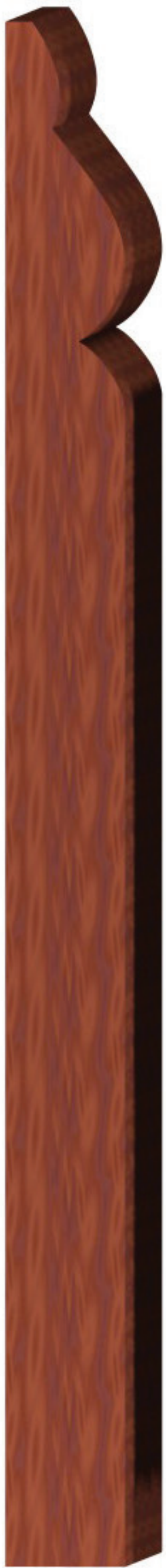

BA48
9/16 x 7-1/4



BA60
3/4 x 6-1/16



BA85
3/4 x up to 10"



BA80
3/4 x 5-1/2



BA63
3/4 x 5-15/16



BA59
5/8 x 5-1/4

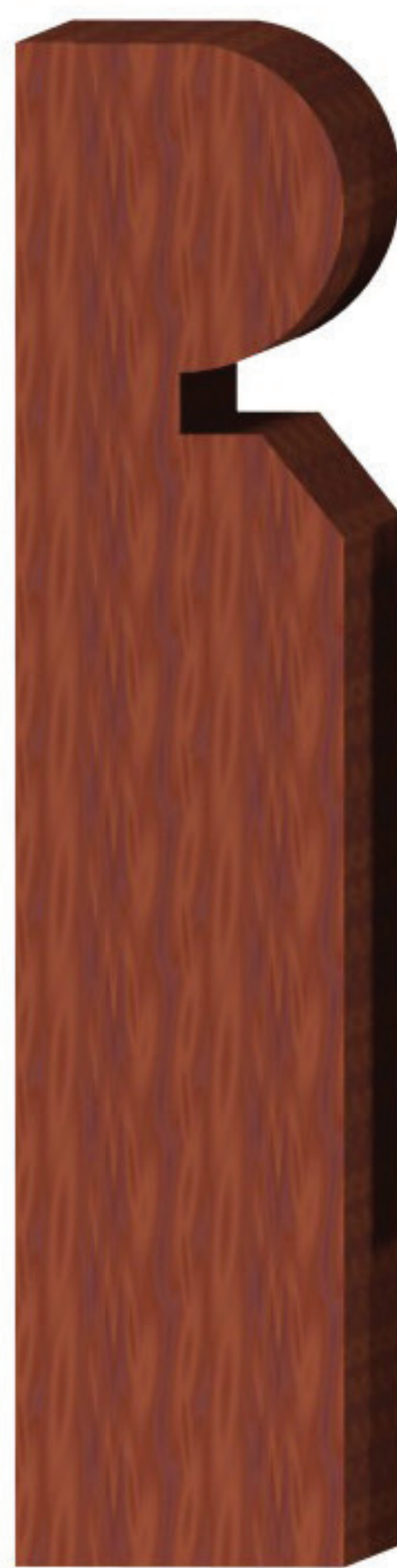

BA07
1 x 4-5/8

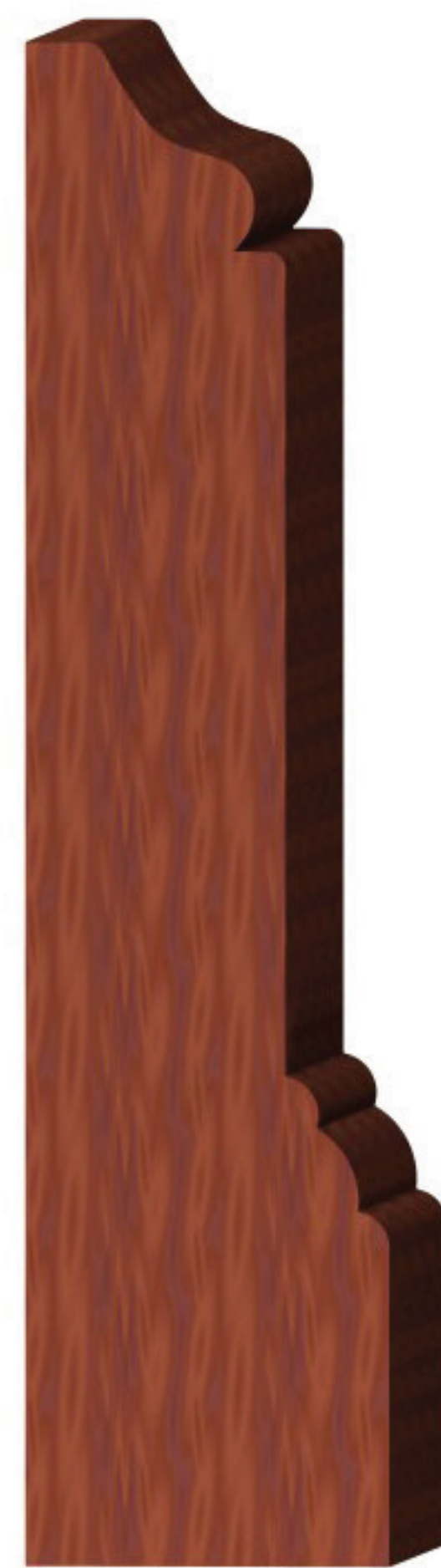

BA10
1-1/8 x 4-5/8



BA33
1 x 7-1/8



BA64
3/4 x 7-1/4



BA100
1 x 6



BA93
13/16 x 5-3/4



BA14
3/4 x 5-9/16



BA15
11/16 x 5-1/2



BA17
11/16 x 5-1/16

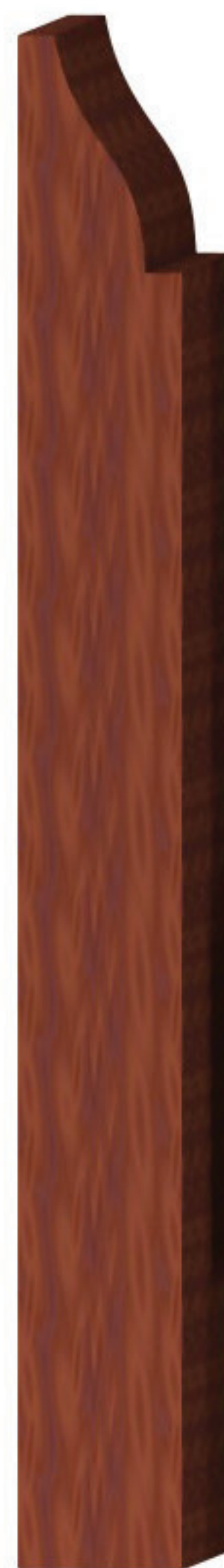

BA02
9/16 x 5-1/16

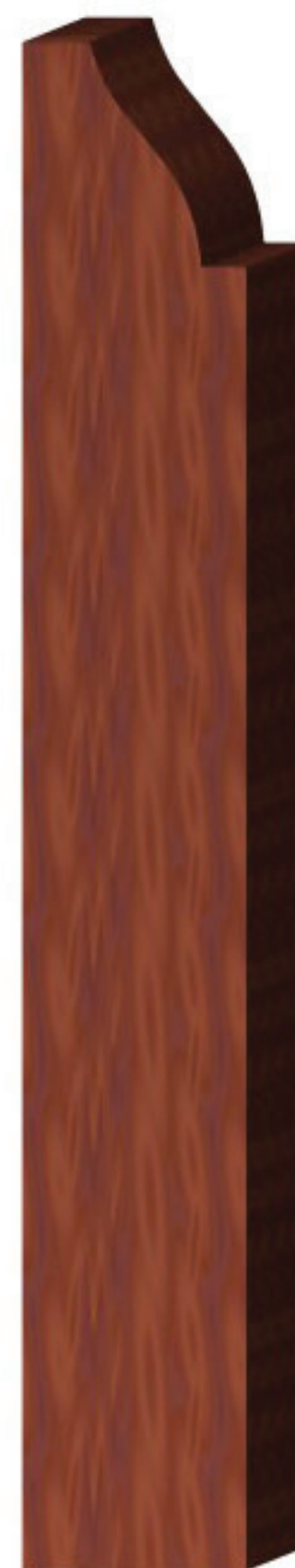

BA23
5/8 x 4-1/4



BA96
11/16 x 7-15/16



BA104
5-7/8 x 7-5/16



BA101
13/16 x 5-1/8



BA24
5/8 x 5-1/4



BA47
1/2 x 5



BA30
9/16 x 3-5/16

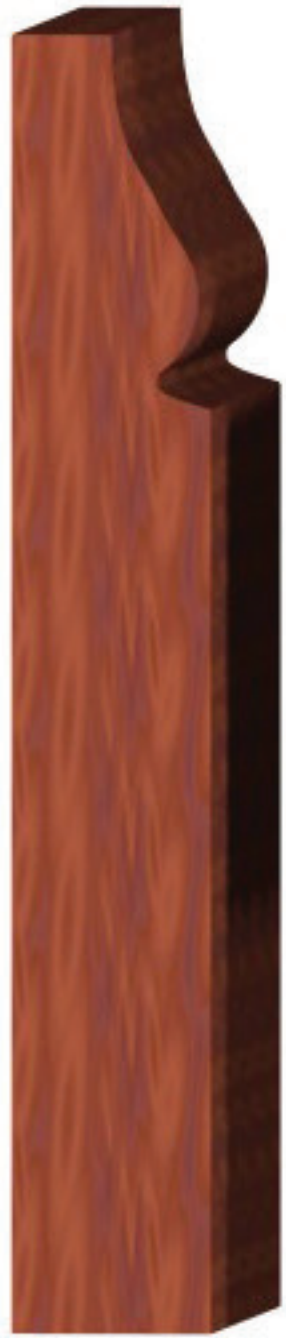

BA53
1/2 x 3-1/4



BA35
7/16 x 2-3/4



BA39
9/16 x 5-3/16



BA78
3/8 x 3-1/4



BA04
3/8 x 3-1/4



BA29
5/16 x 2-1/4

CHAIR RAIL



ID#	Page #	Dimension	ID#	Page #	Dimension
CH01	25	15/16 x 3	CH42	24	7/16 x 2-5/16
CH02	23	1/2 x 2	CH43	24	3/4 x 3-1/2
CH03	23	5/8 x 2-11/16	CH44	26	3/4 x 2-1/4
CH04	25	3/4 x 2	CH45	23	7/16 x 1-3/8
CH05	26	3/4 x 1-1/4	CH46	25	3/4 x 2-3/4
CH06	26	13/16 x 2-1/4			
CH07	25	1-1/8 x 2-1/2			
CH08	23	7/16 x 2-1/4			
CH09	25	11/16 x 2-1/4			
CH10	23	1/2 x 2-3/4			
CH11	25	11/16 x 3			
CH12	26	13/16 x 3-1/2			
CH13	25	11/16 x 2-5/8			
CH14	23	1/2 x 2-3/4			
CH15	24	1/2 x 2-1/4			
CH16	23	7/16 x 1-3/4			
CH17	25	13/16 x 2-1/4			
CH18	25	1-1/16 x 3-1/16			
CH19	25	11/16 x 1-5/8			
CH20	25	3/4 x 2-3/16			
CH21	26	7/8 x 2-1/8			
CH22	26	5/16 x 1-1/8			
CH23	25	3/4 x 1-1/2			
CH24	26	11/16 x 2-3/8			
CH25	26	3/4 x 3			
CH26	24	13/16 x 4-1/2			
CH27	24	3/4 x 3-1/2			
CH28	24	3/8 x 2-5/16			
CH29	23	11/16 x 3			
CH30	24	3/4 x 1-1/2			
CH31	26	11/16 x 3-1/4			
CH32	23	13/16 x 5-1/8			
CH33	26	3/4 x 3-1/2			
CH34	26	1 x 3-1/8			
CH35	23	3/4 x 1-1/2			
CH36	-	-			
CH37	24	7/16 x 1-1/2			
CH38	24	11/16 x 1-1/2			
CH39	23	1/2 x 2			
CH40	26	5/8 x 4-3/16			
CH41	-	-			



CH03 $5/8 \times 2-11/16$



CH29 $11/16 \times 3$



CH45 $7/16 \times 1-3/8$

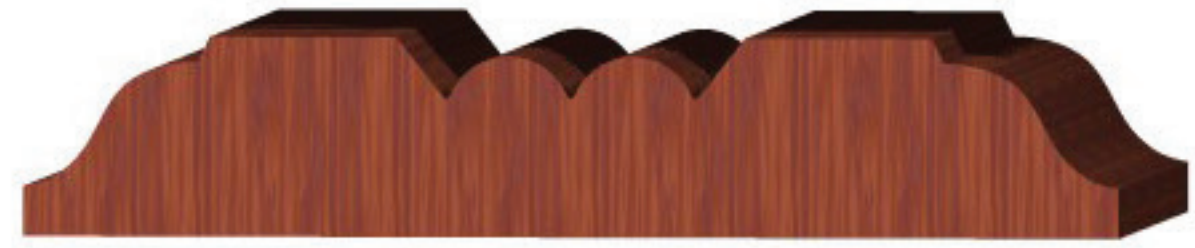

CH14 $1/2 \times 2-3/4$



CH35 $3/4 \times 1-1/2$



CH02 $11/16 \times 2-1/4$



CH16 $7/16 \times 1-3/4$



CH39 $1/2 \times 2$



CH08 $7/16 \times 2-1/4$



CH10 $1/2 \times 2-3/4$

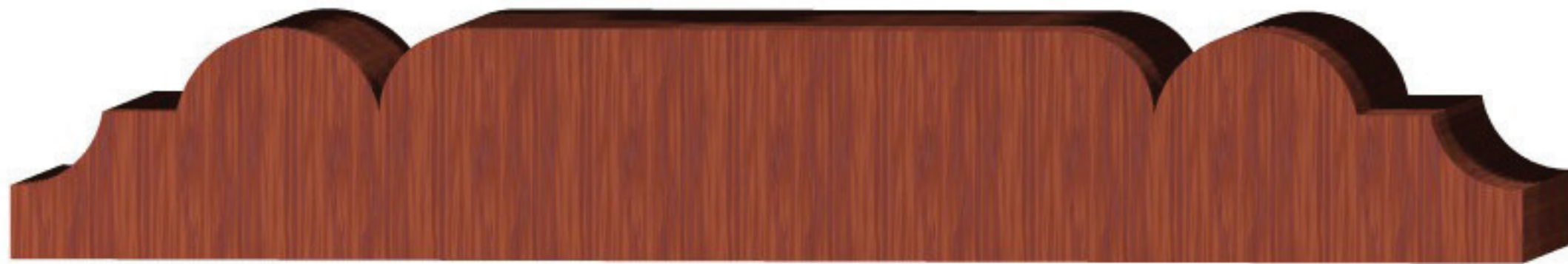

CH32 $13/16 \times 5-1/8$



CH26 $\frac{13}{16}$ x $4\frac{1}{2}$



CH27 $\frac{3}{4}$ x $3\frac{1}{2}$



CH38 $\frac{11}{16}$ x $1\frac{1}{2}$



CH37 $\frac{7}{16}$ x $1\frac{1}{2}$



CH15 $\frac{1}{2}$ x $2\frac{1}{4}$



CH42 $\frac{7}{16}$ x $2\frac{5}{16}$

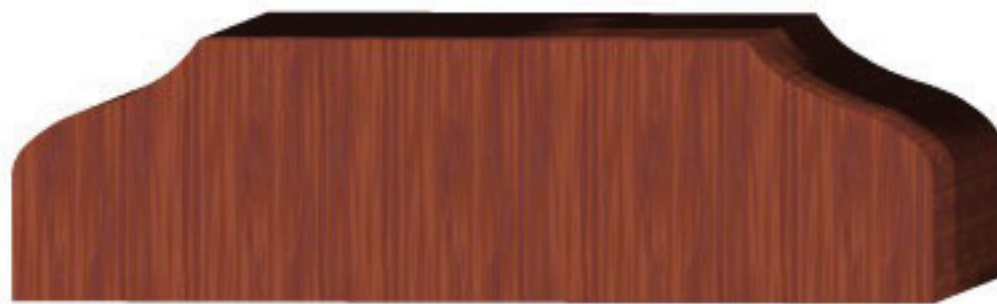

CH28 $\frac{5}{8}$ x $2\frac{5}{16}$



CH30 $\frac{3}{4}$ x $1\frac{1}{2}$

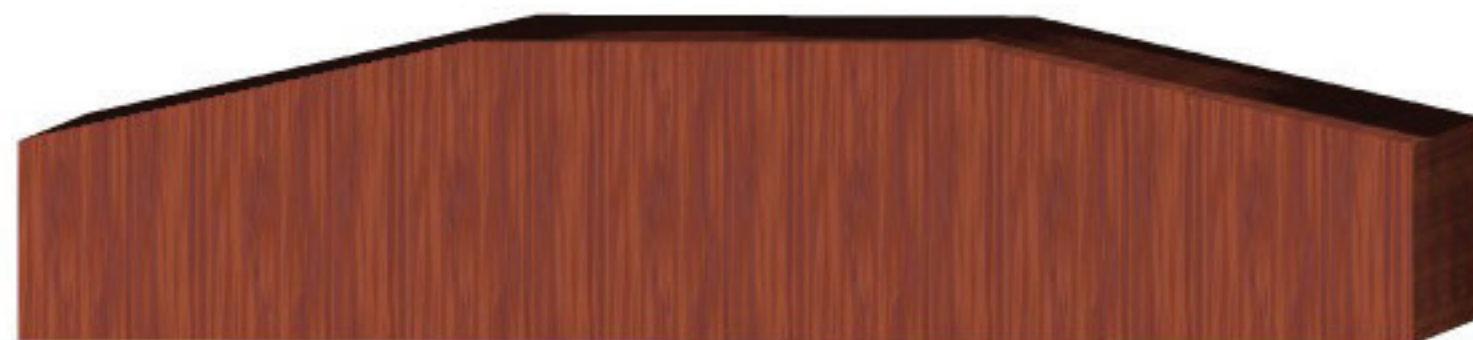

CH43 $\frac{3}{4}$ x $3\frac{1}{2}$



CH04 $\frac{3}{4}$ x 2



CH23 $\frac{3}{4}$ x $1\frac{1}{2}$



CH17 $\frac{13}{16}$ x $2\frac{1}{4}$



CH18 $1\frac{1}{16}$ x $3\frac{1}{16}$



CH46 $\frac{3}{4}$ x $2\frac{3}{4}$



CH01 $\frac{15}{16}$ x 3



CH07 $1\frac{1}{8}$ x $2\frac{1}{2}$



CH20 $\frac{3}{4}$ x $2\frac{3}{16}$



CH19 $\frac{11}{16}$ x $1\frac{5}{8}$



CH09 $\frac{11}{16}$ x $2\frac{1}{4}$



CH11 $\frac{11}{16}$ x 3



CH13 $\frac{11}{16}$ x $2\frac{5}{8}$

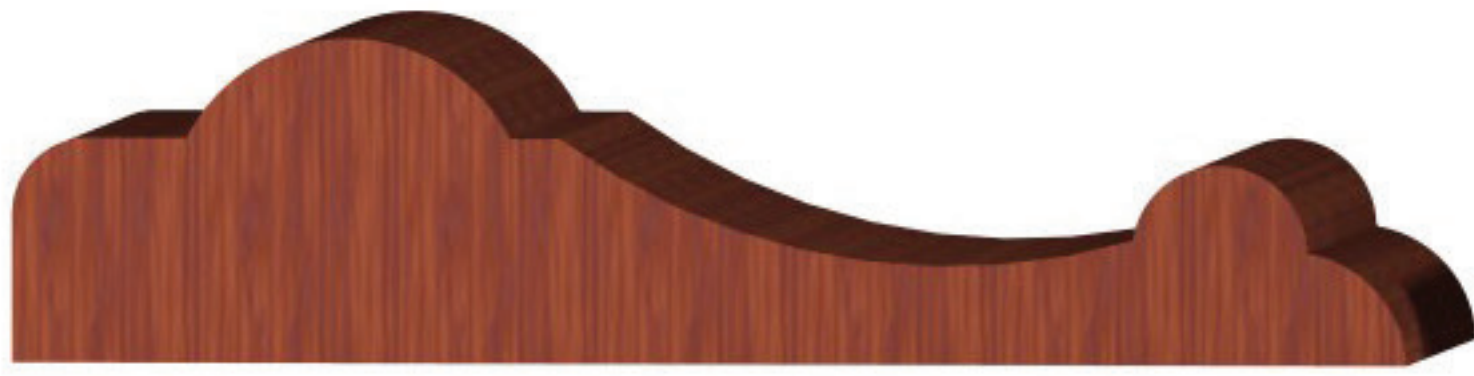

CH12 $\frac{13}{16}$ x $3\frac{1}{2}$



CH05 $\frac{3}{4}$ x $1\frac{1}{4}$

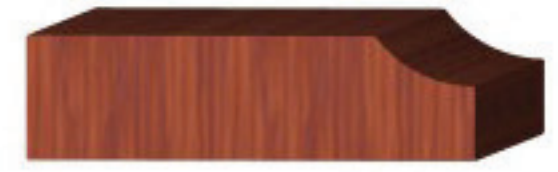

CH22 $\frac{5}{16}$ x $1\frac{1}{8}$



CH34 1 x $3\frac{1}{8}$



CH31 $\frac{11}{16}$ x $3\frac{1}{4}$



CH33 $\frac{3}{4}$ x $3\frac{1}{2}$



CH25 $\frac{3}{4}$ x 3



CH06 $\frac{13}{16}$ x $2\frac{1}{4}$



CH21 $\frac{7}{8}$ x $2\frac{1}{8}$



CH44 $\frac{3}{4}$ x $2\frac{1}{4}$



CH24 $\frac{11}{16}$ x $2\frac{3}{8}$

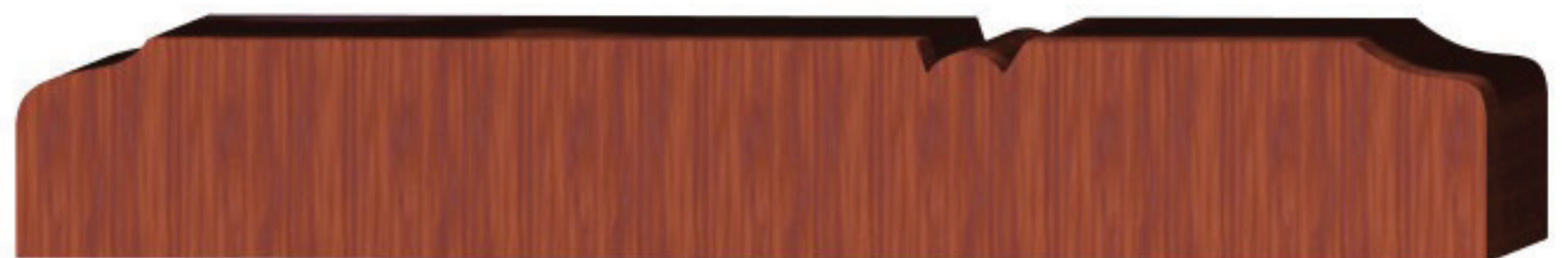

CH40 $\frac{5}{8}$ x $4\frac{3}{16}$

CROWN

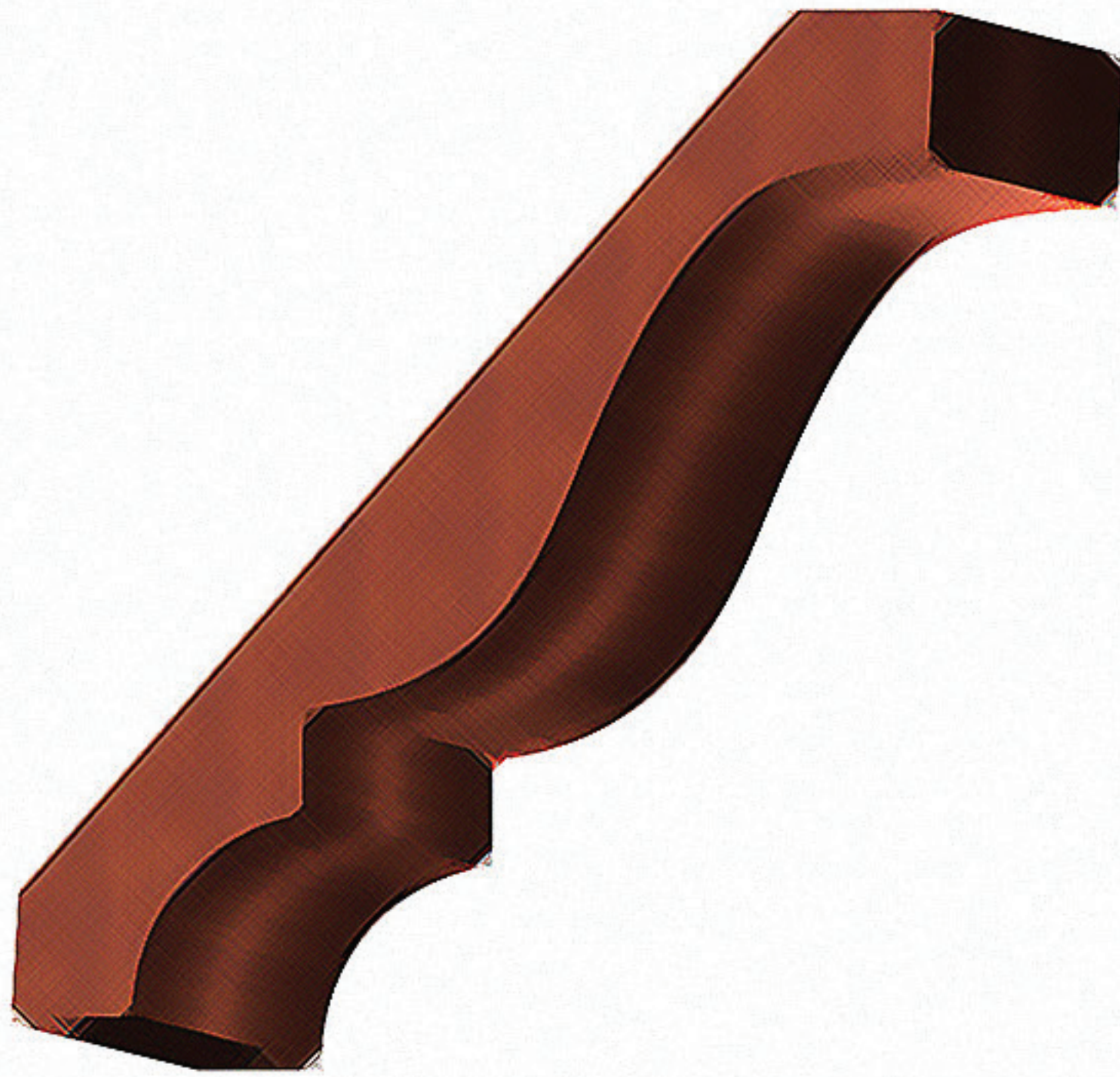

ID#	Page #	Dimension	ID#	Page #	Dimension
CR01	70	3/4 x 4-1/2	CR42	45	3/4 x 4-15/16
CR02	66	3/4 x 3-5/16	CR43	45	3/4 x 3-3/16
CR03	50	7/8 x 5-1/2	CR44	43	1-1/16 x 4-1/4
CR04	45	1-1/4 x 6	CR45	54	3/4 x 3-1/2
CR05	37	11/16 x 1-9/16	CR46	50	5/8 x 15/16
CR06	37	3/4 x 1-1/16	CR47	31	5/8 x 3-1/4
CR07	38	1-1/4 x 2-3/16	CR48	54	5/8 x 2-5/8
CR08	66	7/8 x 4-1/4	CR49	54	9/16 x 1-13/16
CR09	37	7/8 x 1-1/8	CR50	60	1-1/16 x 5-5/16
CR10	37	3/4 x 1-1/2	CR51	33	3/4 x 5-3/8
CR11	30	3/4 x 4-1/4	CR52	35	3/4 x 5-3/4
CR12	70	5/8 x 3-5/16	CR53	32	1-5/16 x 7
CR13	37	3/4 x 1-1/16	CR54	62	7/8 x 2-1/4
CR14	37	1 x 1-3/4	CR55	55	1/2 x 2-1/4
CR15	37	3/4 x 1-1/16	CR56	36	11/16 x 3-3/8
CR16	39	1-11/16 x 1-11/16	CR57	31	5/8 x 1-3/4
CR17	37	1-1/4 x 2	CR58	41	5/8 x 2-1/4
CR18	37	3/4 x 1-11/16	CR59	37	15/16 x 1-5/8
CR19	37	3/4 x 1-1/2	CR60	43	3/4 x 4-1/8
CR20	45	11/16 x 4-1/8	CR61	37	15/16 x 1-13/16
CR21	37	5/8 x 7/8	CR62	50	3/4 x 5/8
CR22	38	1-1/2 x 3-1/4	CR63	67	11/16 x 4-1/2
CR23	45	11/16 x 3-1/4	CR64	36	1/2 x 2-9/16
CR24	60	11/16 x 3-5/8	CR65	55	3/4 x 1-11/16
CR25	43	9/16 x 2	CR66	63	1-1/2 x 4-1/16
CR26	38	1-3/4 x 2-7/8	CR67	42	1-5/16 x 5-1/2
CR27	31	5/8 x 2-3/4	CR68	32	3/4 x 7-1/2
CR28	30	3/4 x 4-1/2	CR69	46	13/16 x 6-1/8
CR29	35	3/4 x 4-1/16	CR70	64	7/8 x 6-1/2
CR30	30	3/4 x 5-1/8	CR71	56	3/4 x 4-3/4
CR31	36	3/4 x 3-5/8	CR72	68	13/16 x 6-1/4
CR32	43	3/4 x 2-1/2	CR73	51	13/16 x 6
CR33	31	5/8 x 2-1/4	CR74	55	7/8 x 1-7/16
CR34	56	7/8 x 5-5/16	CR75	60	3/4 x 3-3/4
CR35	46	7/8 x 6	CR76	47	1/2 x 3-1/16
CR36	67	7/8 x 5-13/16	CR77	60	1/4 x 5-3/8
CR37	47	3/4 x 1-13/16	CR78	71	3/4 x 6-1/2
CR38	67	3/4 x 5-9/16	CR79	67	3/4 x 6-1/2
CR39	70	5/8 x 5-1/16	CR80	41	1-3/8 x 4-11/16
CR40	50	3/4 x 3-13/16	CR81	56	7/8 x 3-11/16
CR41	41	1-3/8 x 5-3/4	CR82	38	1-1/16 x 2-3/16

ID#	Page #	Dimension	ID#	Page #	Dimension
CR83	35	7/8 x 6-5/16	CR124	51	3/4 x 2-1/2
CR84	57	13/16 x 5	CR125	66	11/16 x 2-7/8
CR85	31	1-1/16 x 5-7/16	CR126	40	13/16 x 1-1/4
CR86	50	3/4 x 3-3/4	CR127	36	3/4 x 3-1/4
CR87	48	13/16 x 6	CR128	54	3/4 x 3-1/4
CR88	51	3/4 x 3-9/16	CR129	51	3/4 x 3-1/4
CR89	70	3-1/16 x 4-3/16	CR130	49	1-1/4 x 6-5/8
CR90	47	1-11/16 x 7	CR131	68	1/4 x 4-1/4
CR91	47	1-1/16 x 5-9/16	CR132	33	5/8 x 4-9/16
CR92	50	11/16 x 5-3/16	CR133	31	3/4 x 5-7/16
CR93	56	9/16 x 4-3/16	CR134	45	1/2 x 3-1/16
CR94	68	3/4 x 4-7/8	CR135	64	3/4 x 4-11/16
CR95	42	3/4 x 3-9/16	CR136	56	13/16 x 4
CR96	56	5/8 x 3-1/8	CR137	-	-
CR97	42	3/4 x 2-1/4	CR138	39	1-7/8 x 1-15/16
CR98	40	1-3/4 x 2	CR139	73	3/4 x 3
CR99	41	1/2 x 2	CR140	43	1-3/8 x 3-7/8
CR100	69	1-1/4 x 7-5/8	CR141	58	3/4 x 2-1/8
CR101	69	1-3/8 x 7	CR142	44	3/4 x 5-3/4
CR102	73	1 x 5-3/16	CR143	73	1/2 x 5/8
CR103	40	1-5/8 x 1-5/8	CR144	73	5/8 x 5/8
CR104	57	1/8 x 6-9/16	CR145	73	1/2 x 5/8
CR105	61	1-1/4 x 5-3/8	CR146	65	5/8 x 2-7/8
CR106	62	3/4 x 3-1/2	CR147	42	1-1/8 x 3
CR107	61	3/4 x 4-13/16	CR148	55	13/16 x 3-1/16
CR108	-	-	CR149	66	5/8 x 3-1/4
CR109	47	3/4 x 3-1/2	CR150	41	3/4 x 3-1/2
CR110			CR151	39	1-1/8 x 2-3/16
CR111	61	3/4 x 3-3/4	CR152	55	7/8 x 2-1/4
CR112	-	-	CR153	58	7/8 x 3-11/16
CR113	70	9/16 x 3-5/16	CR154	62	11/16 x 2
CR114	47	3/4 x 5-9/16	CR155	62	13/16 x 2-13/16
CR115	54	1-3/16 x 3	CR156	62	13/16 x 4
CR116	31	13/16 x 3-5/16	CR157	58	9/16 x 3-5/8
CR117	55	13/16 x 3	CR158	44	3/4 x 3-5/16
CR118	-	-	CR159	-	-
CR119	-	-	CR160	48	3/4 x 5-5/16
CR120	36	3/4 x 3-13/16	CR161	49	11/16 x 3-3/8
CR121	51	3/4 x 2-1/2	CR162	63	1-1/4 x 5-3/8
CR122	73	3/4 x 2-15/16	CR163	63	13/16 x 3-11/16
CR123	54	13/16 x 3-15/16	CR164	-	-

ID#	Page #	Dimension	ID#	Page #	Dimension
CR165	39	1-7/8 x 3-3/16	CR206	-	-
CR166	39	1-3/4 x 1-7/8	CR207	55	7/8 x 4-7/16
CR167	39	1 x 1-5/16	CR208	38	1-3/4 x 3-1/4
CR168	38	1-7/16 x 2-1/2	CR209	40	7/8 x 2-1/2
CR169	33	1/2 x 2-9/16	CR210	42	1-1/2 x 4-5/16
CR170	71	7/8 x 6-1/8	CR211	73	1-3/8 x 4-3/8
CR171	48	3/4 x 6-7/8	CR212	40	3/4 x 1-1/2
CR172	39	3/4 x 1-3/4	CR213	63	1-5/8 x 5-5/16
CR173	49	1-1/2 x 4-5/8	CR214	49	7/8 x 3-3/8
CR174	-	-	CR215	52	3/4 x 2-3/4
CR175	64	5/8 x 3-1/4	CR216	30	3/4 x 5-1/2
CR176	53	1-1/8 x 8-1/8	CR217	32	3/4 x 5-1/2
CR177	33	1-11/16 x 3-5/16	CR218	40	13/16 x 15/16
CR178	33	7/16 x 2-1/4	CR219	54	3/4 x 2-1/8
CR179	34	7/8 x 7-3/16	CR220	52	13/16 x 2-5/8
CR180	44	3/4 x 3-13/16	CR221	62	3/4 x 2-5/8
CR181	65	13/16 x 4-5/8	CR222	40	1-5/8 x 2-5/8
CR182	46	9/16 x 3-3/16	CR223	52	13/16 x 2-7/8
CR183	-	-	CR224	46	3/4 x 4-5/8
CR184	44	1 x 3-15/16	CR225	40	1-3/8 x 2-5/8
CR185	33	1/2 x 1-11/16	CR226	-	-
CR186	72	1-1/4 x 6-13/16	CR227	39	1-1/16 x 1-3/4
CR187	34	3/4 x 5-1/4	CR228	57	1-1/2 x 6-1/2
CR188	70	5/8 x 3-13/16	CR229	65	13/16 x 3-1/2
CR189	52	7/8 x 3-3/4	CR230	-	-
CR190	52	13/16 x 3-1/2	CR231	40	1-7/8 x 2-5/8
CR191	39	1-3/4 x 3	CR232	36	3/4 x 3-3/4
CR192	58	1-1/8 x 5-9/16			
CR193	53	7/8 x 4-1/4			
CR194	44	3/4 x 3-5/8			
CR195	68	15/16 x 5-3/4			
CR196	34	1-1/16 x 4-5/8			
CR197	64	3/4 x 4-1/4			
CR198	59	1-1/2 x 9-1/4			
CR199	52	3 x 4			
CR200	42	7/8 x 4-1/2			
CR201	-	-			
CR202	40	3/4 x 3/4			
CR203	66	3/4 x 3			
CR204	47	1/2 x 1-1/4			
CR205	59	1-1/8 x 5-3/4			

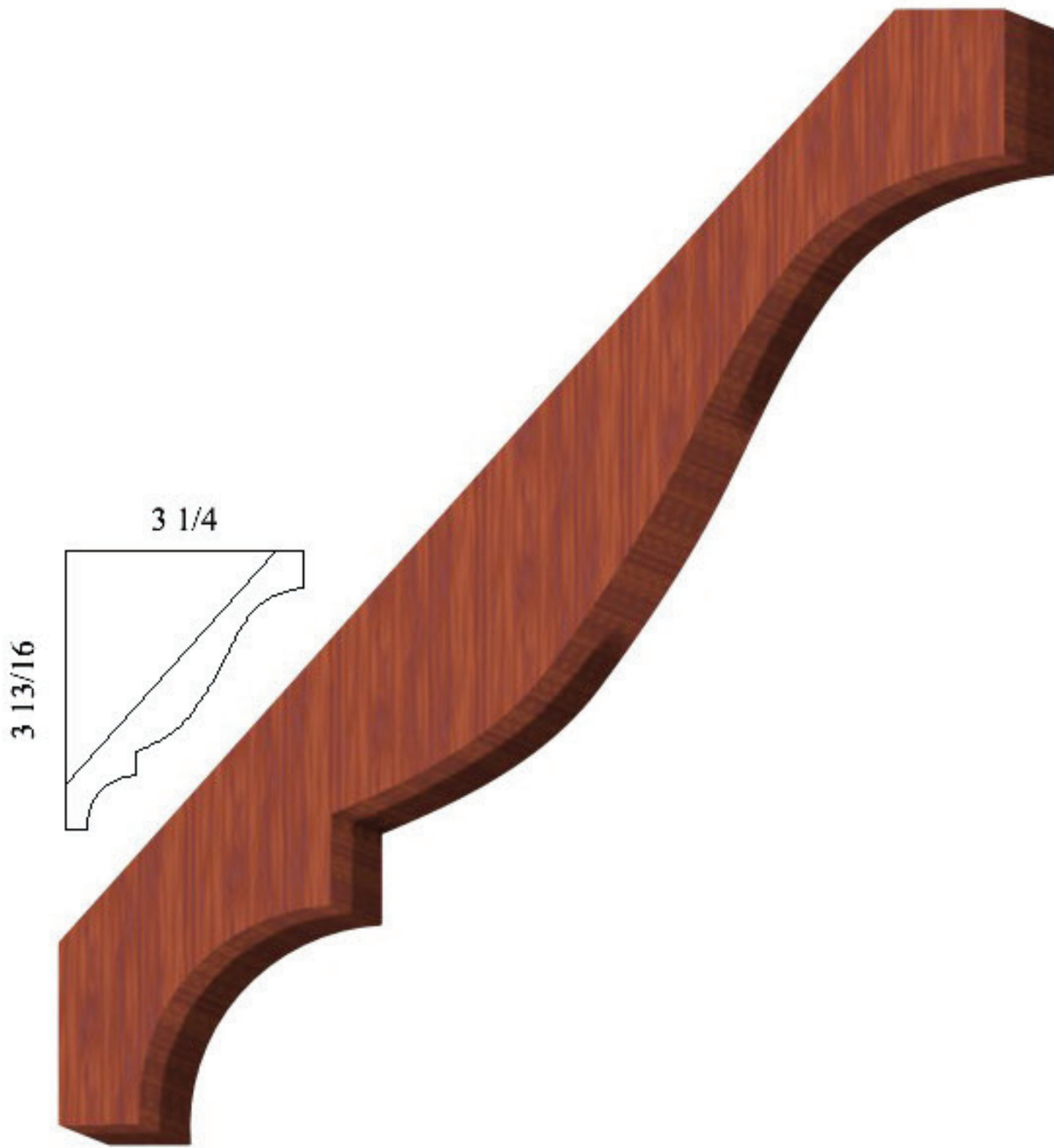

CR30
 $\frac{3}{4} \times 5 - \frac{1}{8}$

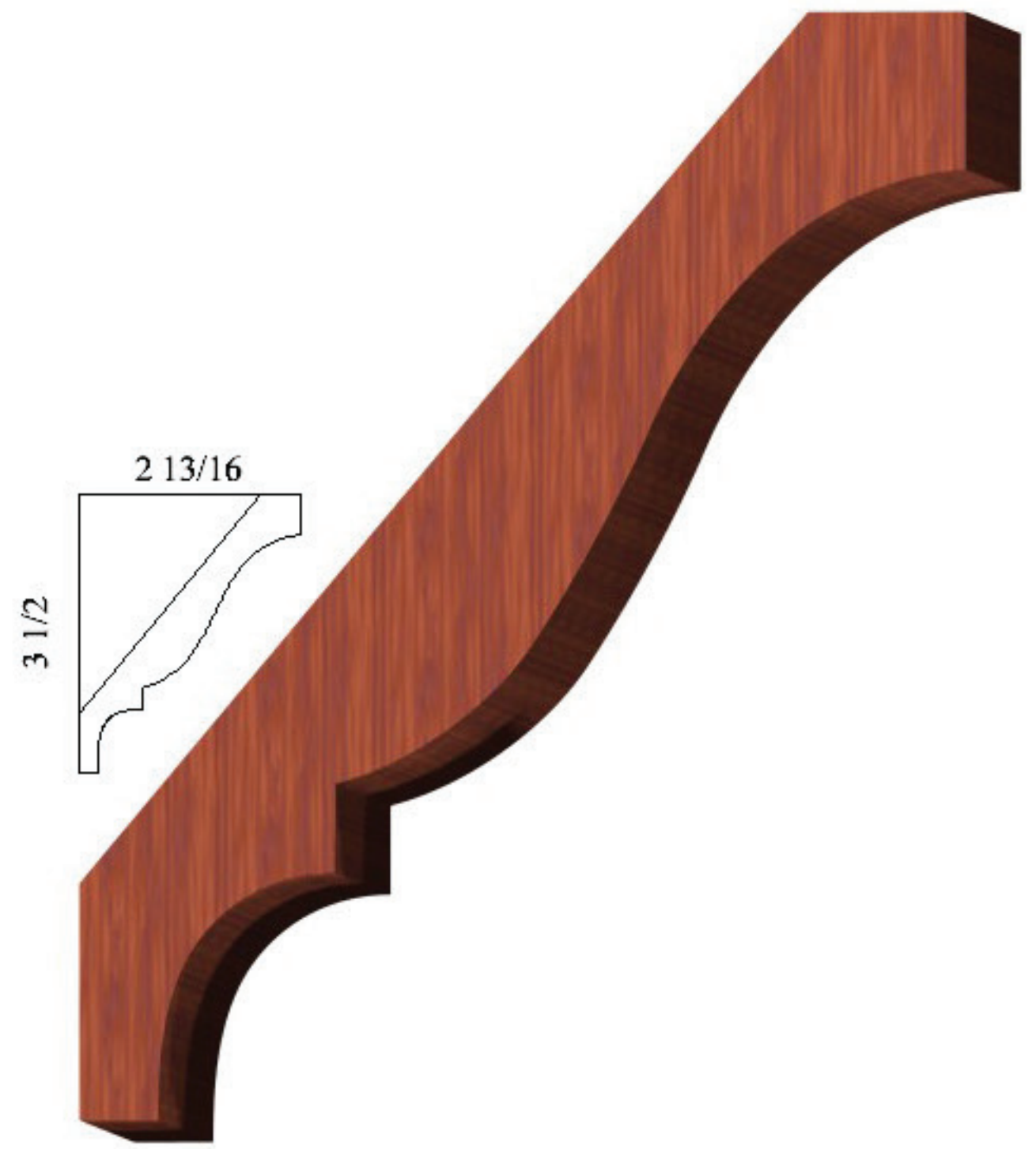

CR28
 $\frac{3}{4} \times 4 - \frac{1}{2}$

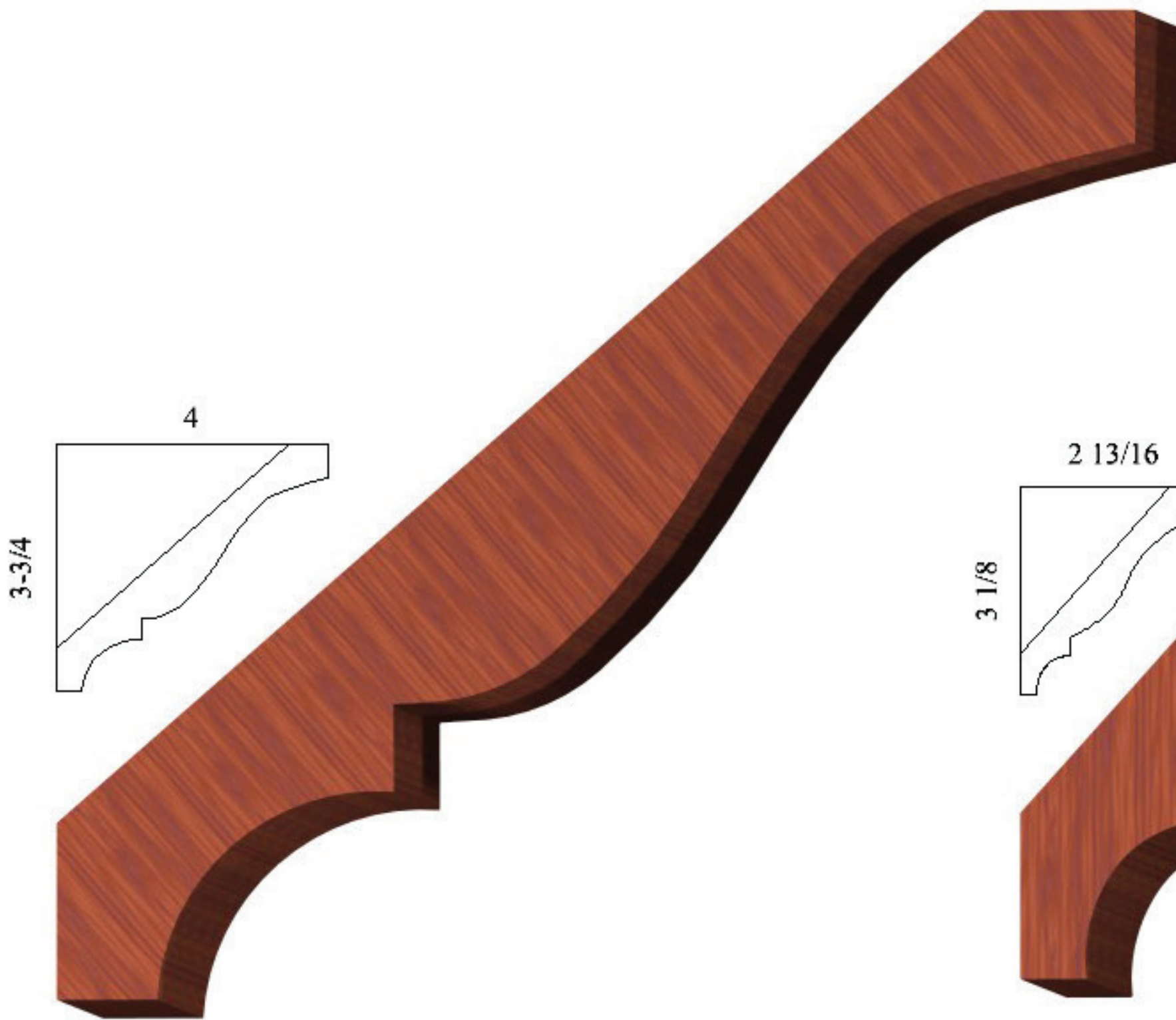

CR216
 $\frac{3}{4} \times 5 - \frac{1}{2}$

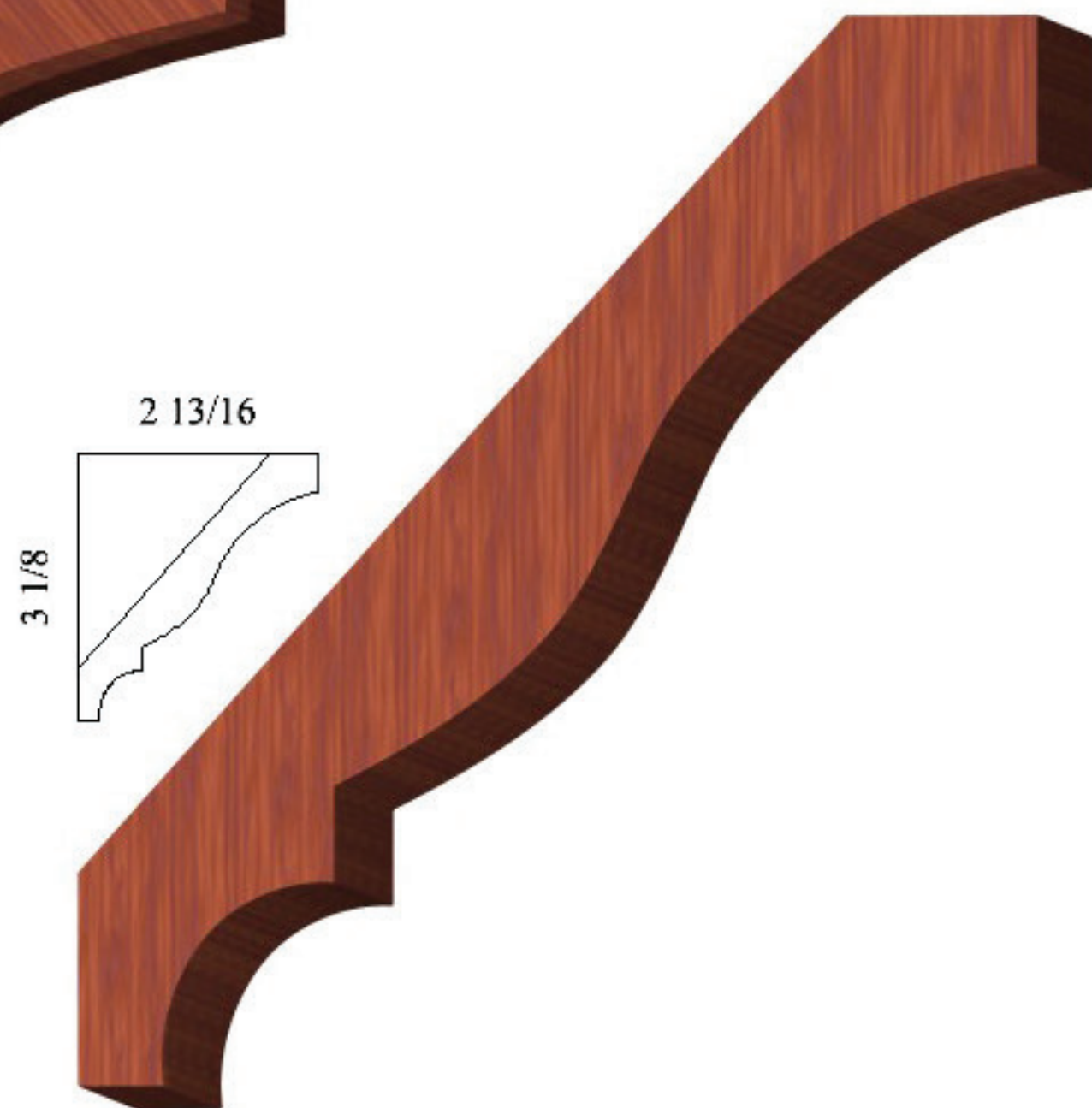

CR11
 $\frac{3}{4} \times 4 - \frac{1}{4}$

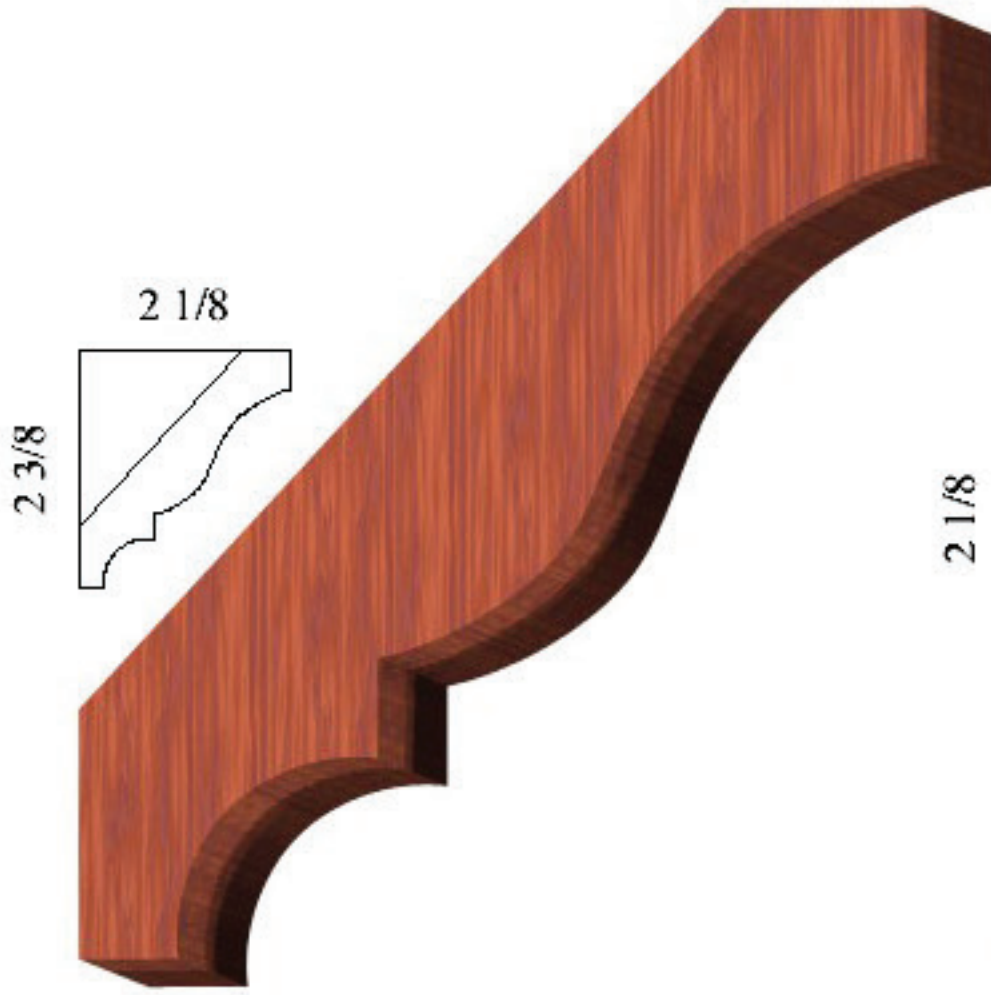

CR47
5/8 x 3-1/4

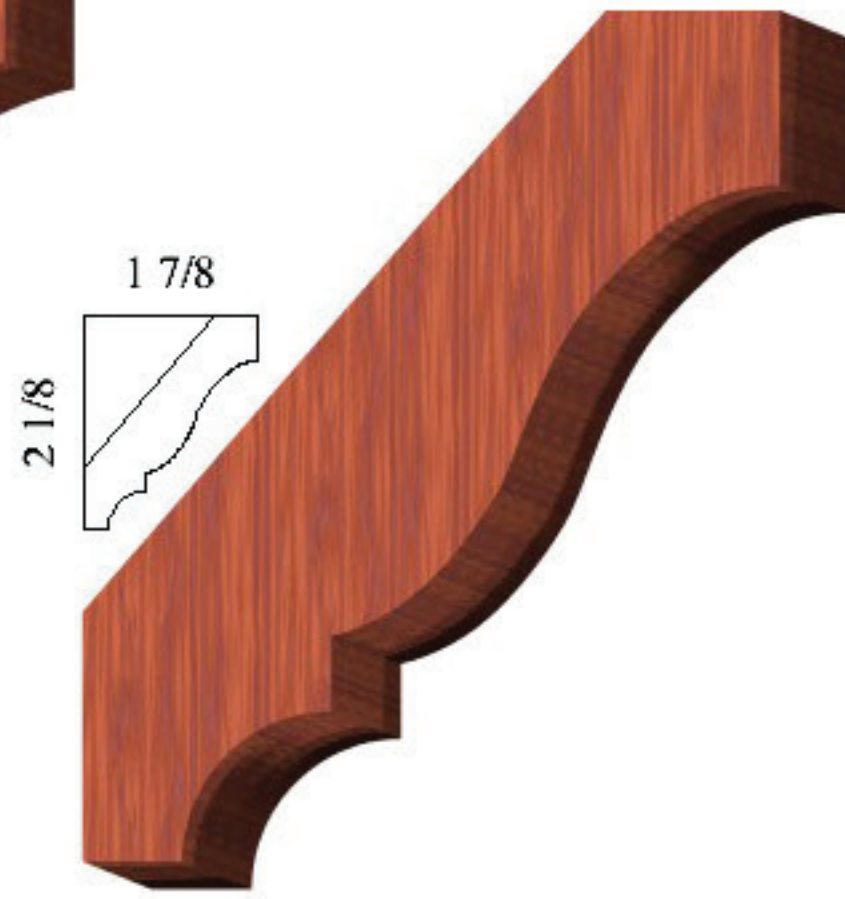

CR27
5/8 X 2-3/4

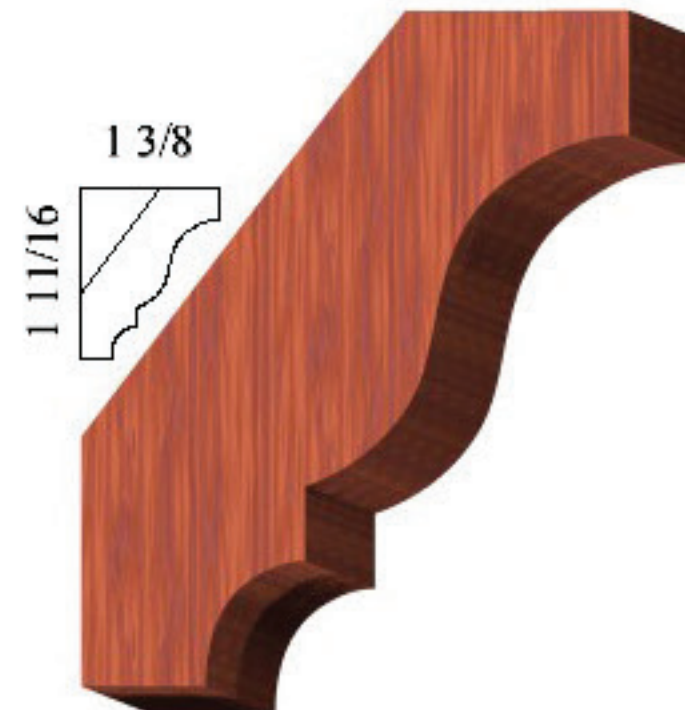

CR33
5/8 X 2-1/4

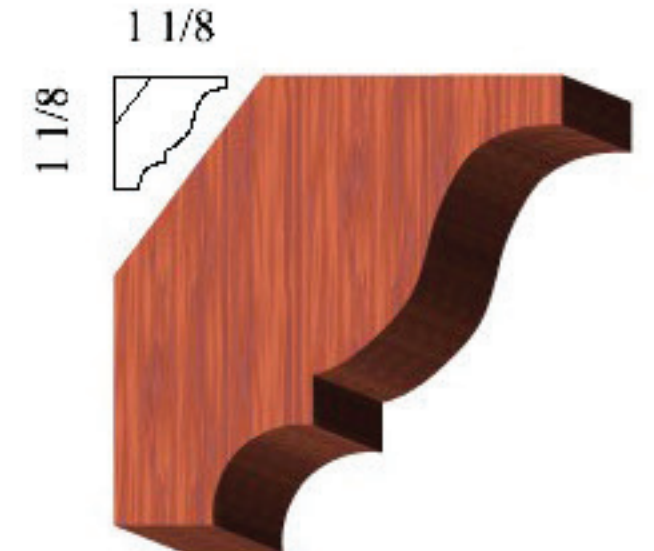

CR57
5/8 x 1-3/4

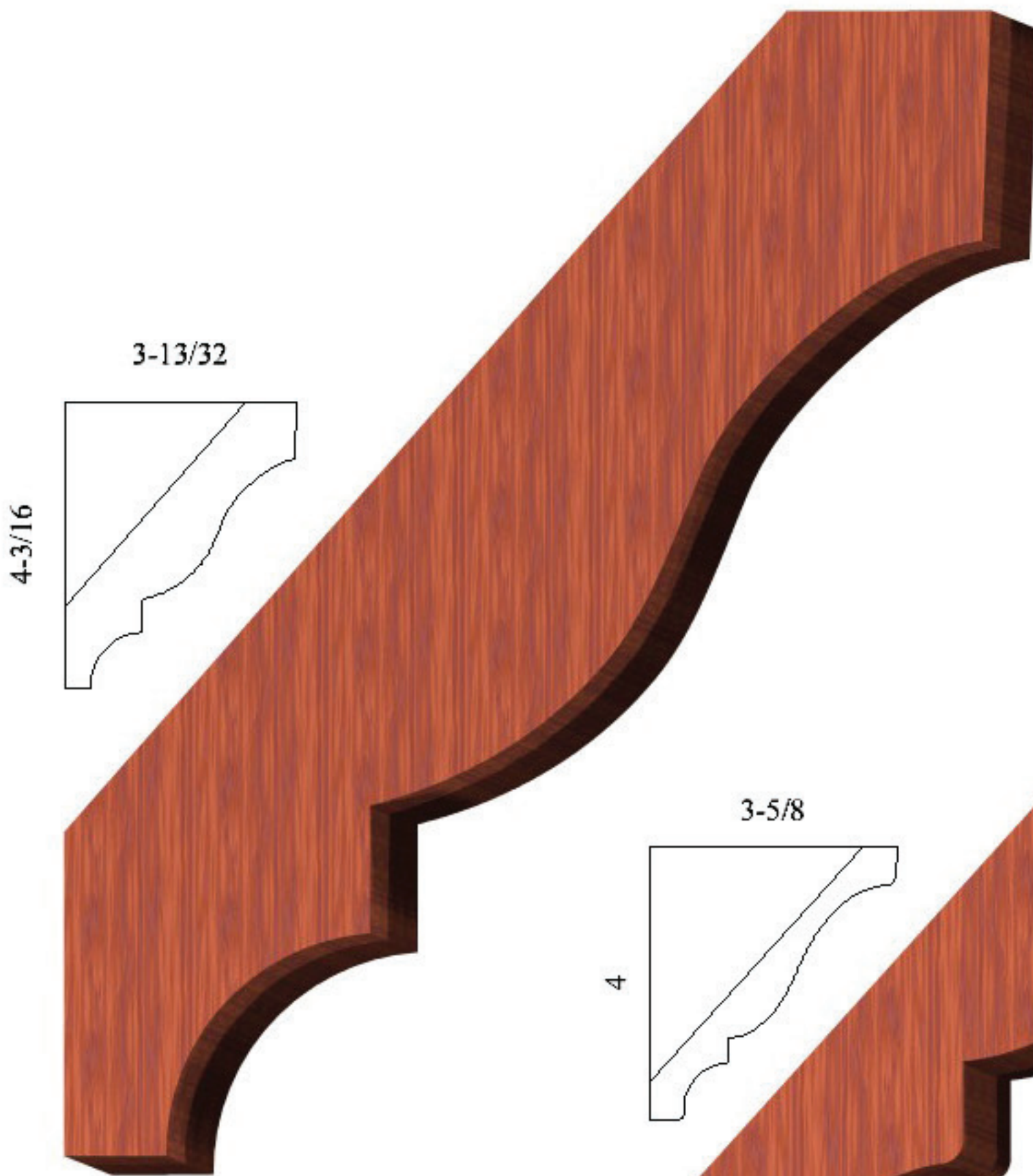

CR85
1-1/16 x 5-7/16

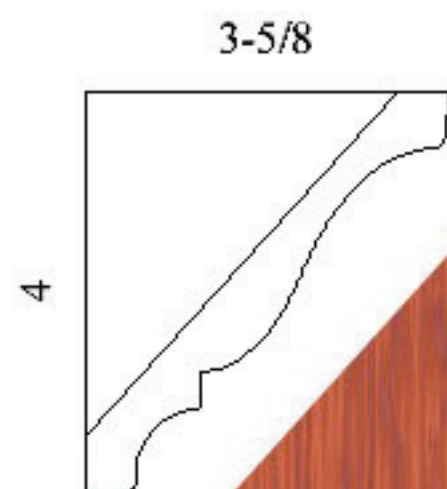

CR133
3/4 x 5-7/16

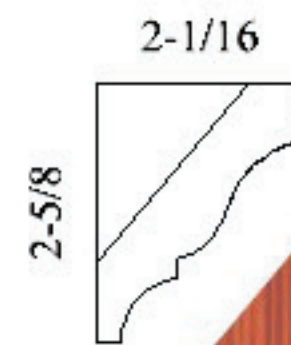

CR116
13/16 x 3-5/16

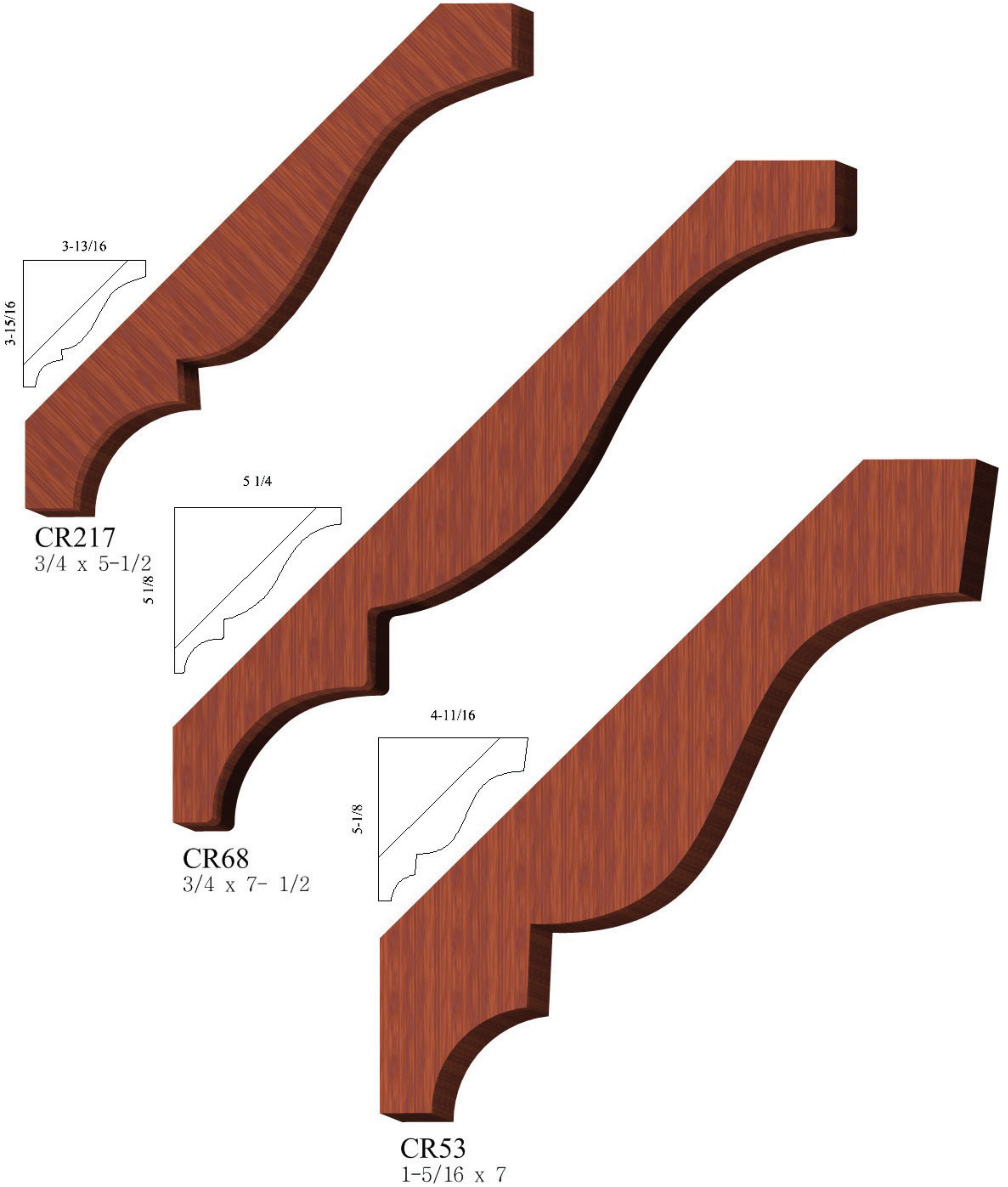

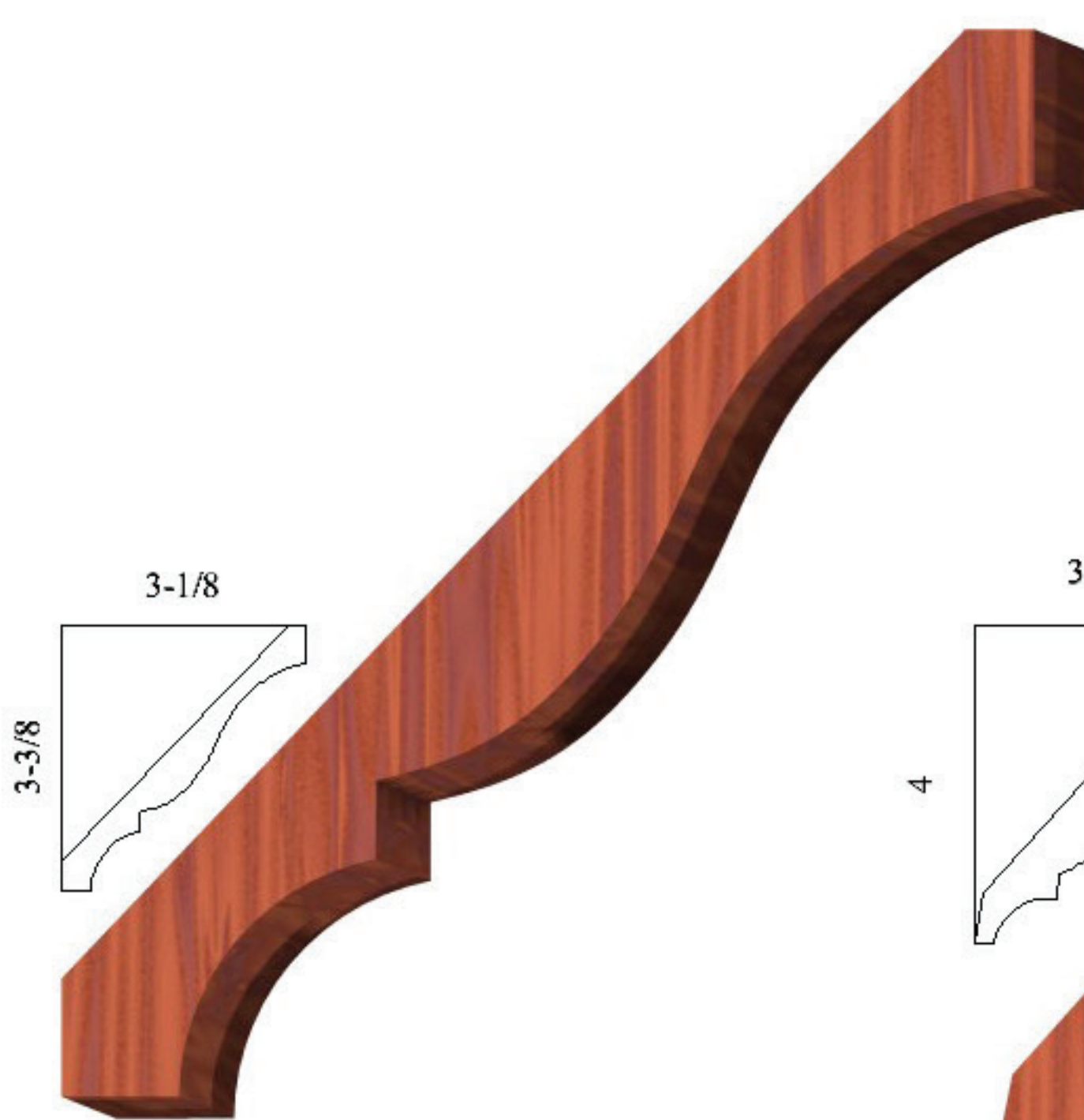

CR132
5/8 x 4-9/16

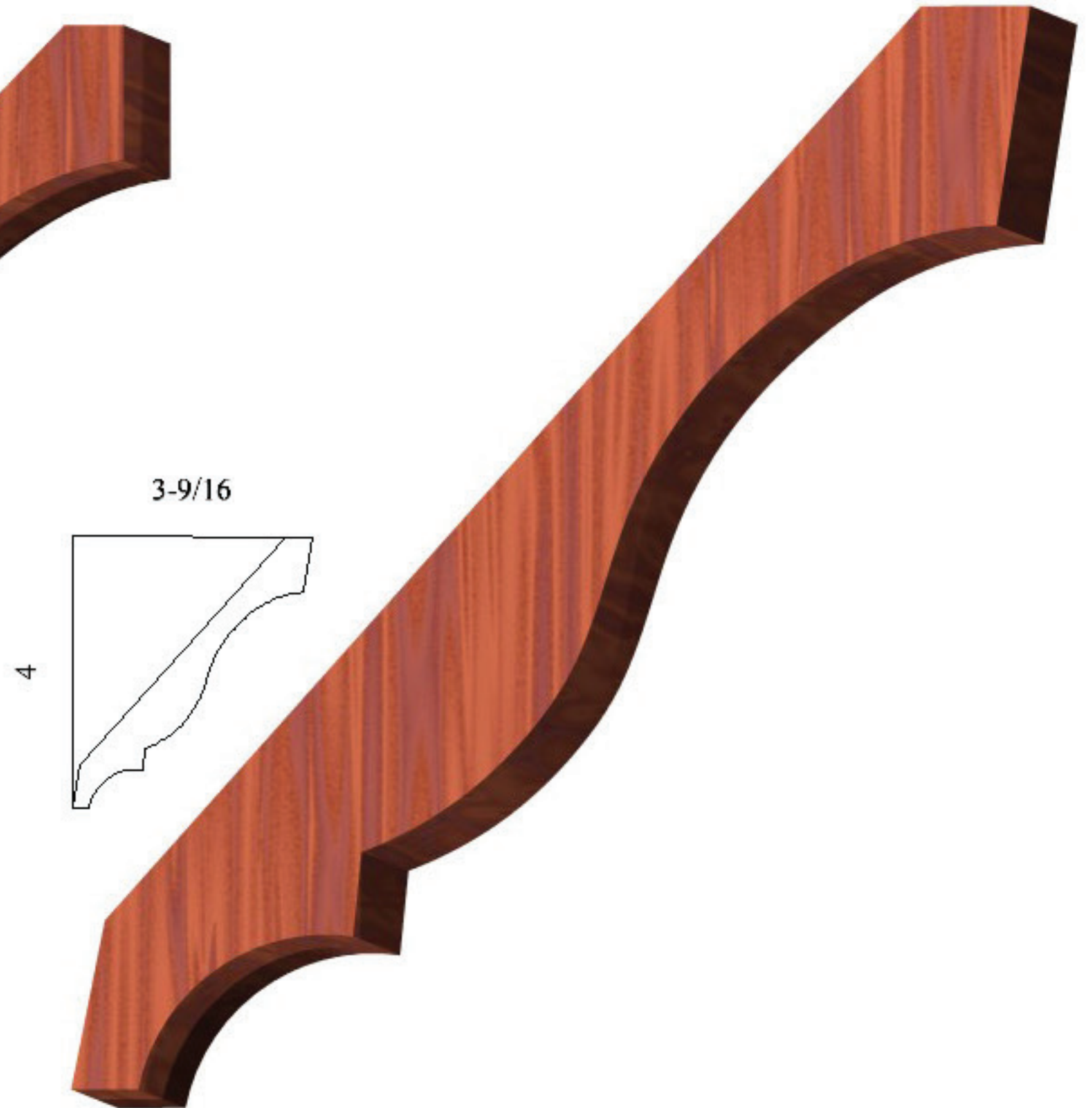

CR51
3/4 x 5-3/8

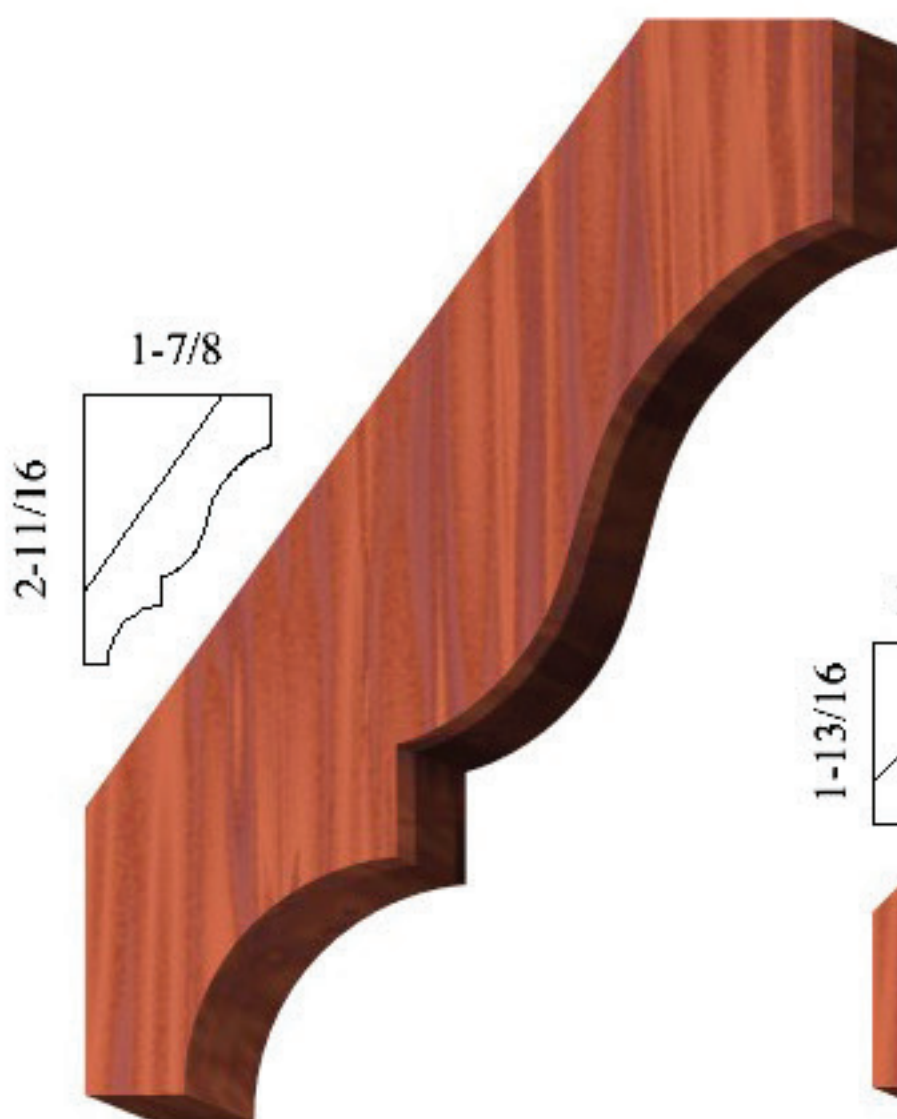

CR177
1-11/16 x 3-5/16

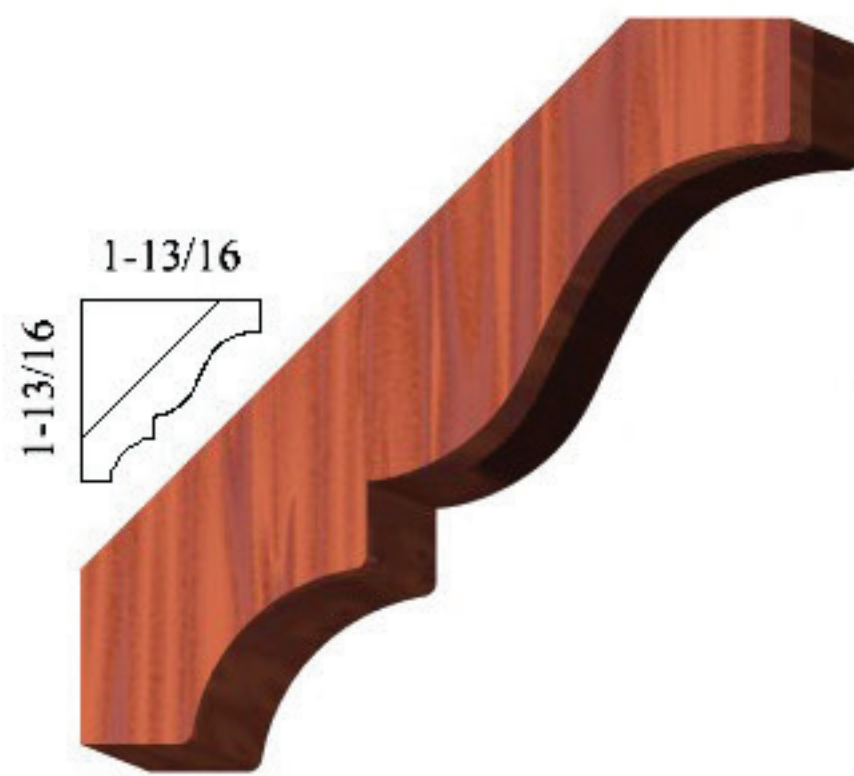

CR169
1/2 x 2-9/16

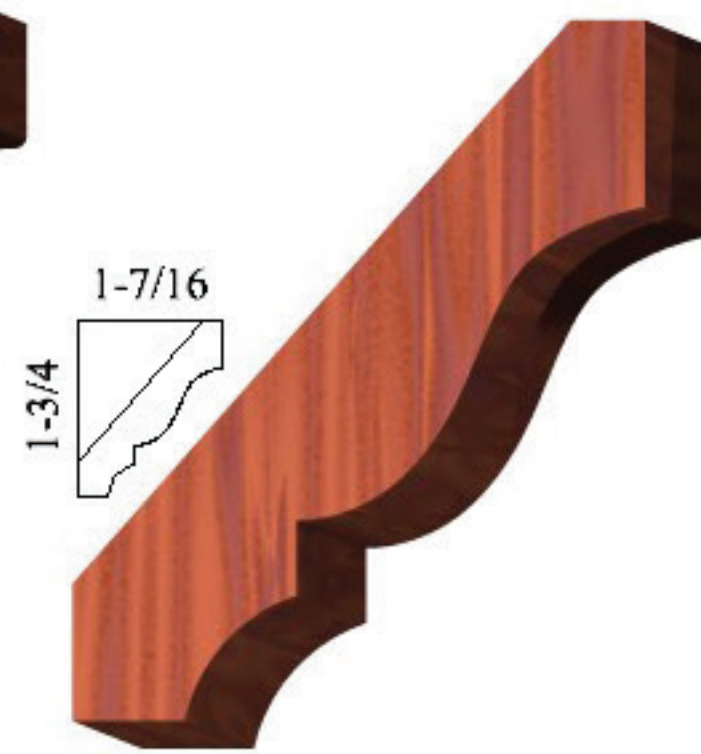

CR178
7/16 x 2-1/4

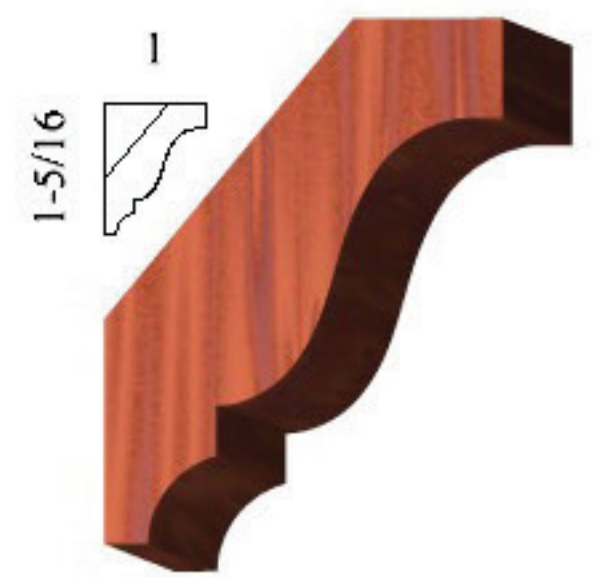

CR185
1/2 x 1-11/16

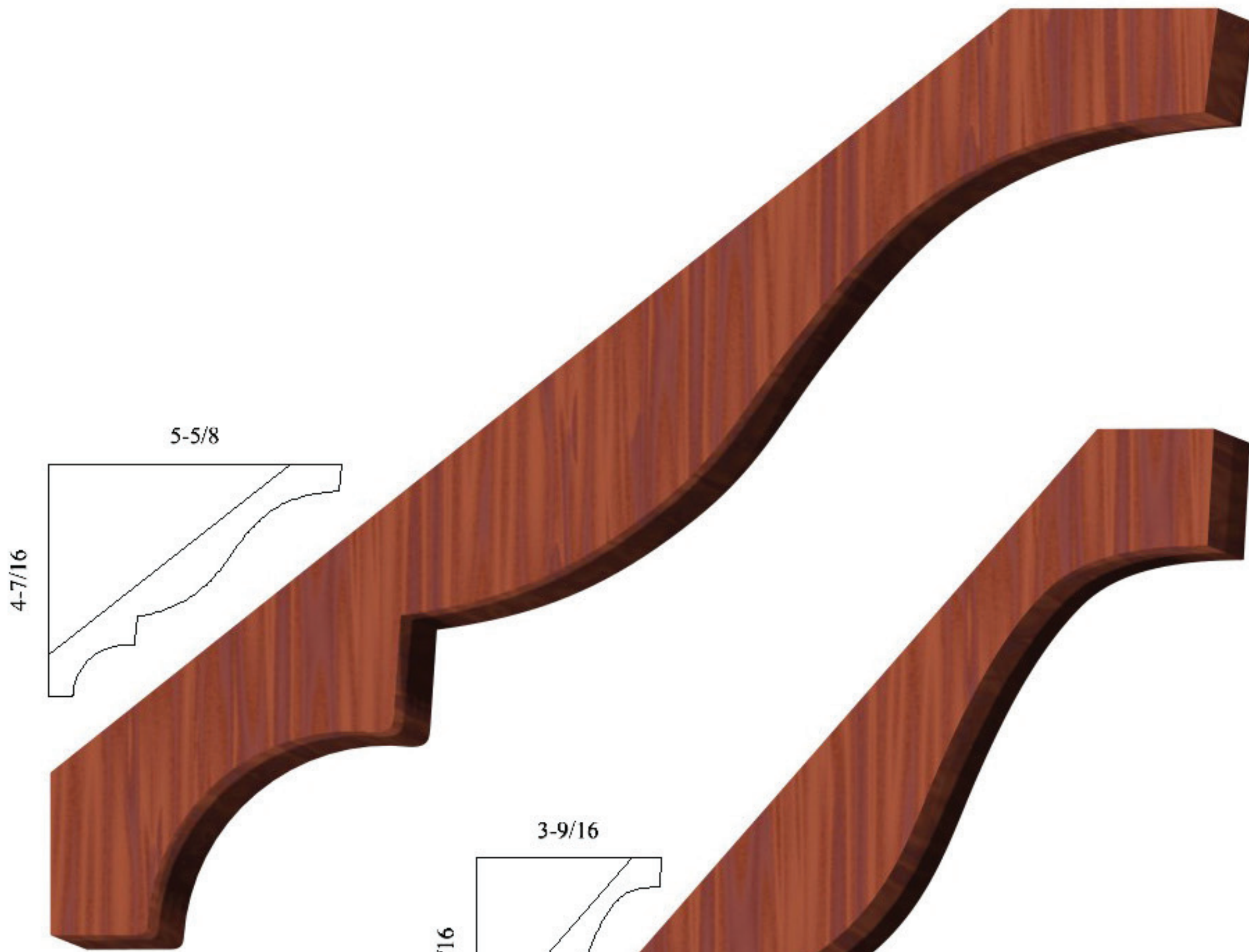

CR179
 $7/8 \times 7\text{-}3/16$

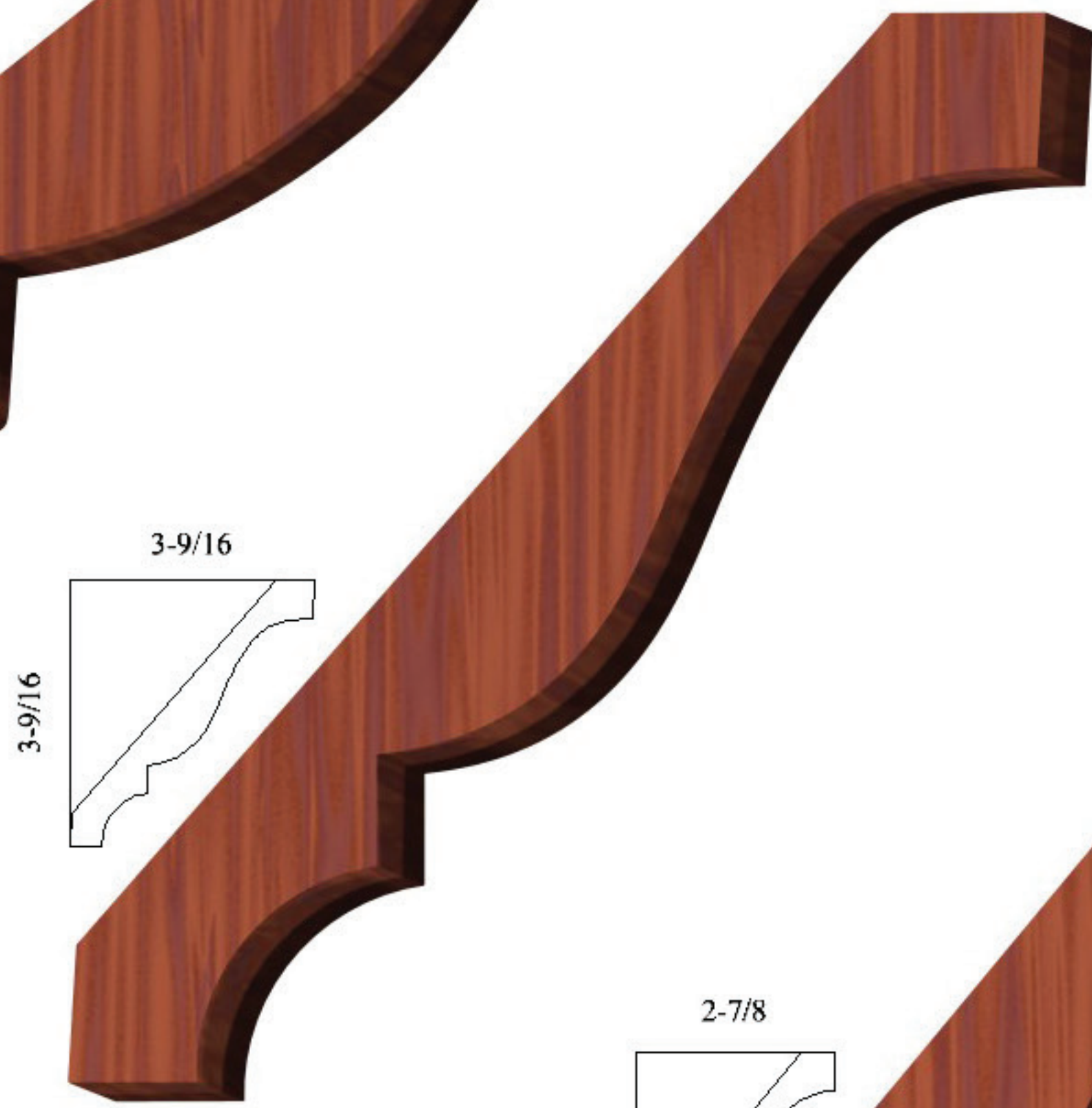

CR187
 $3/4 \times 5\text{-}1/4$

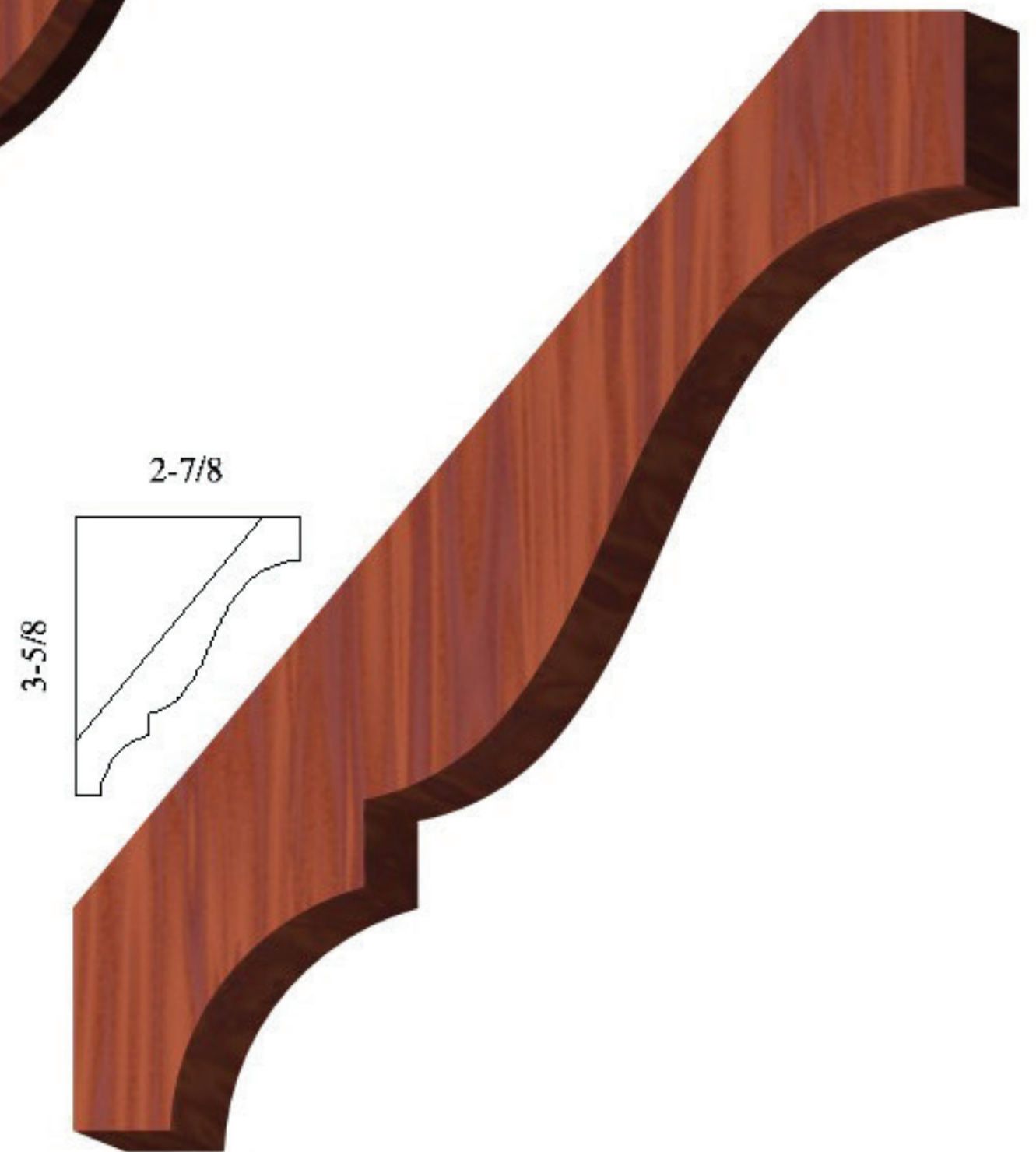

CR196
 $1\text{-}1/16 \times 4\text{-}5/8$

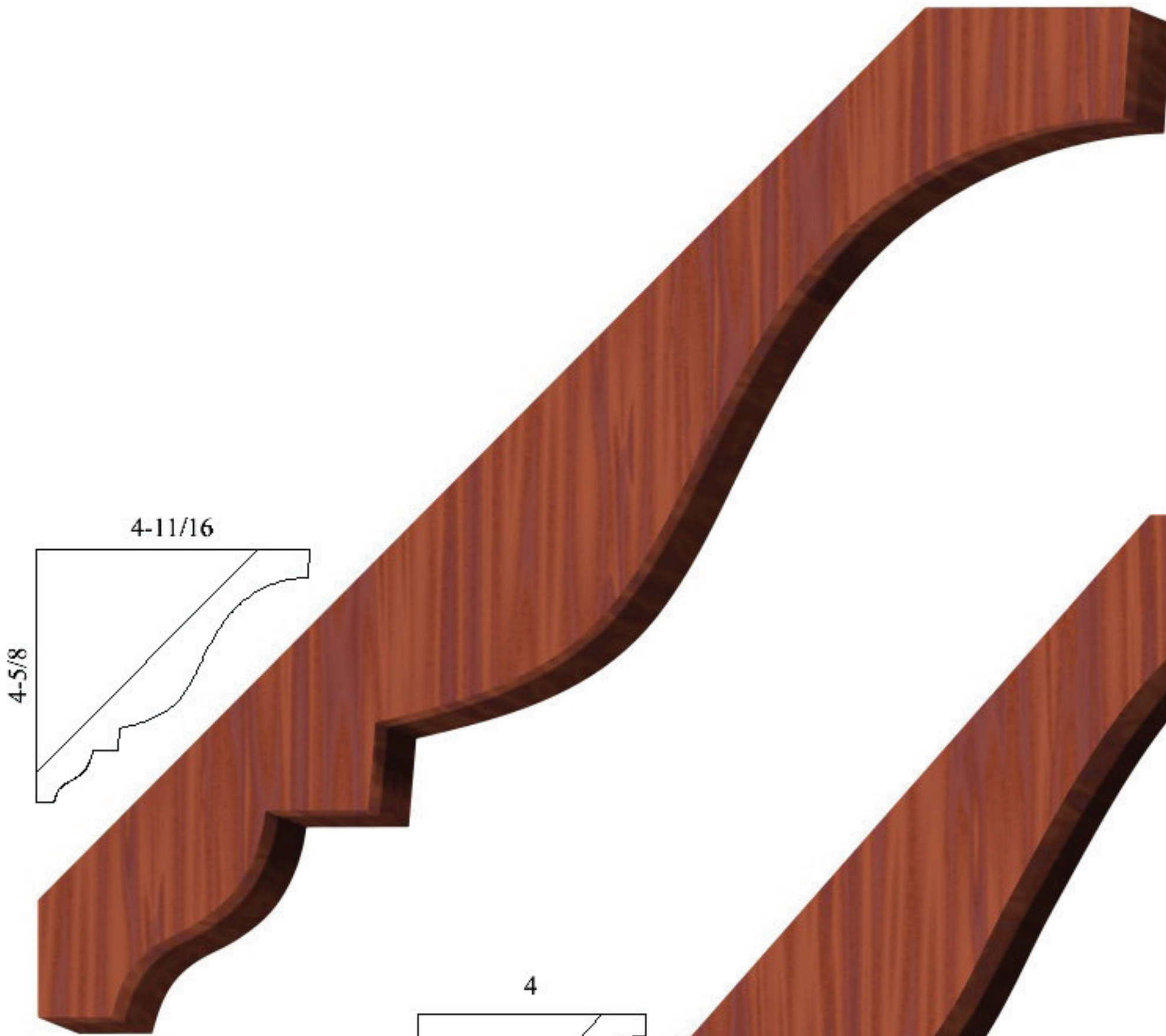

CR83
7/8 x 6-5/16

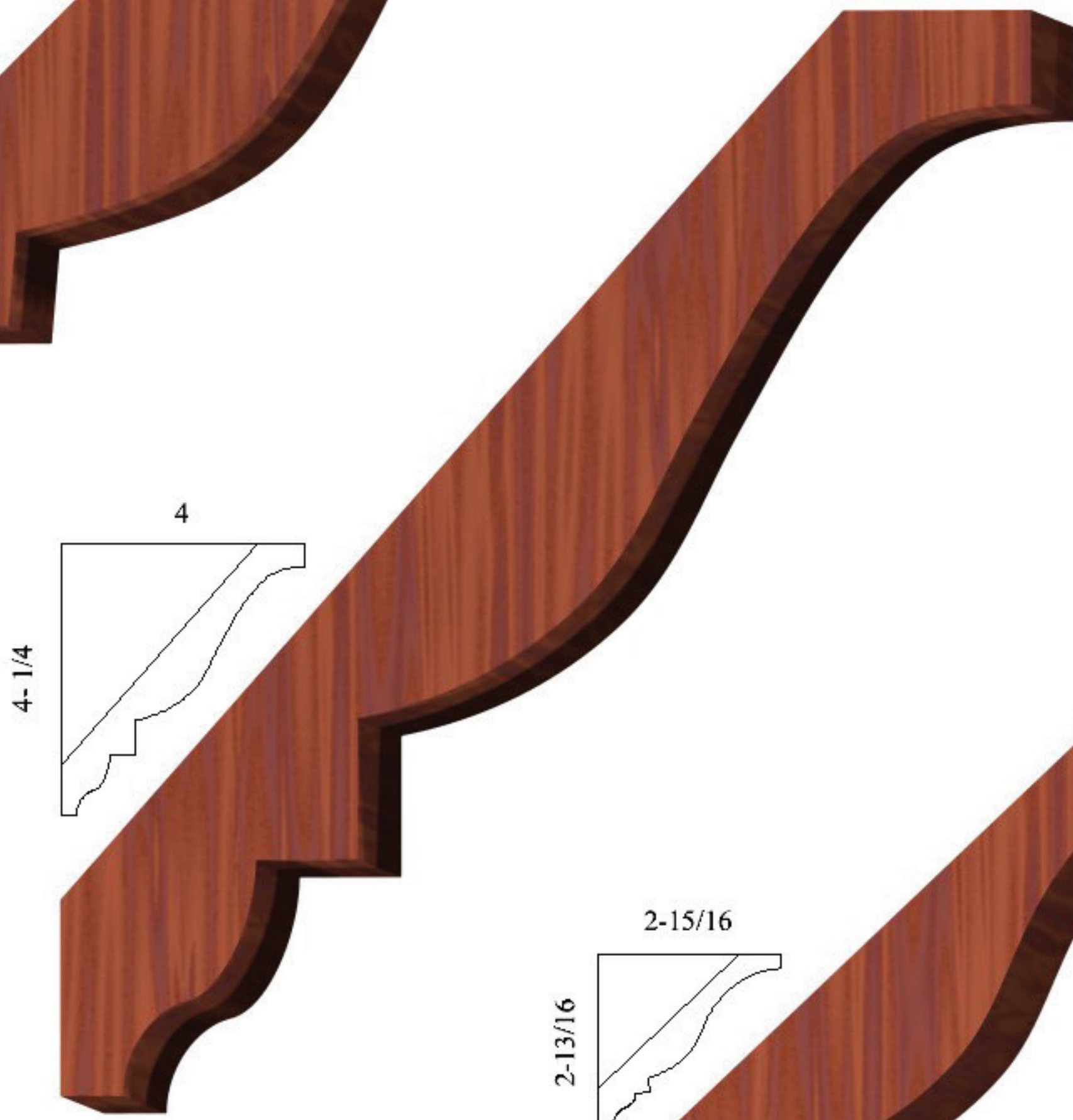

CR 52
3/4 X 5-3/4

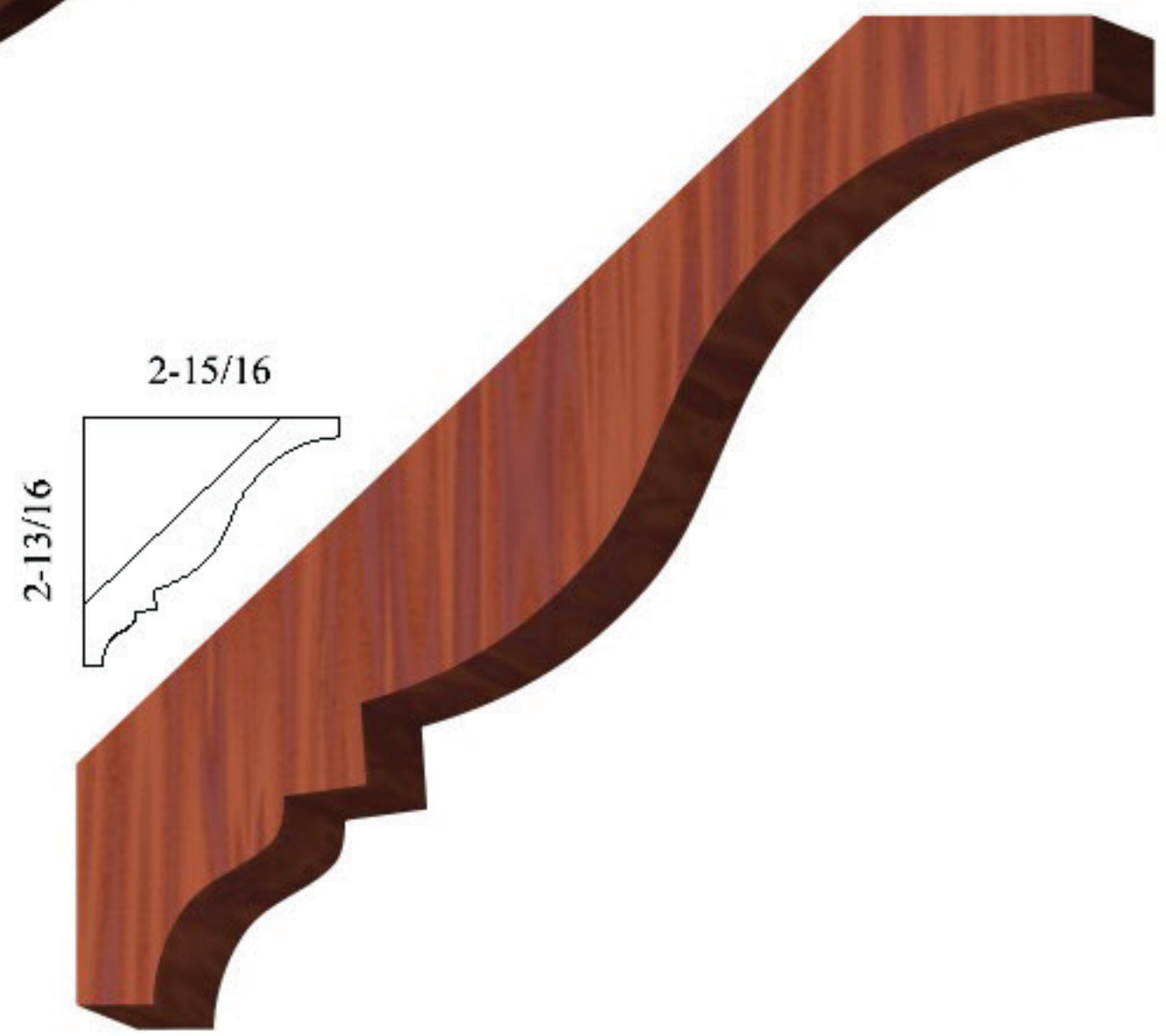

CR29
3/4 x 4-1/16

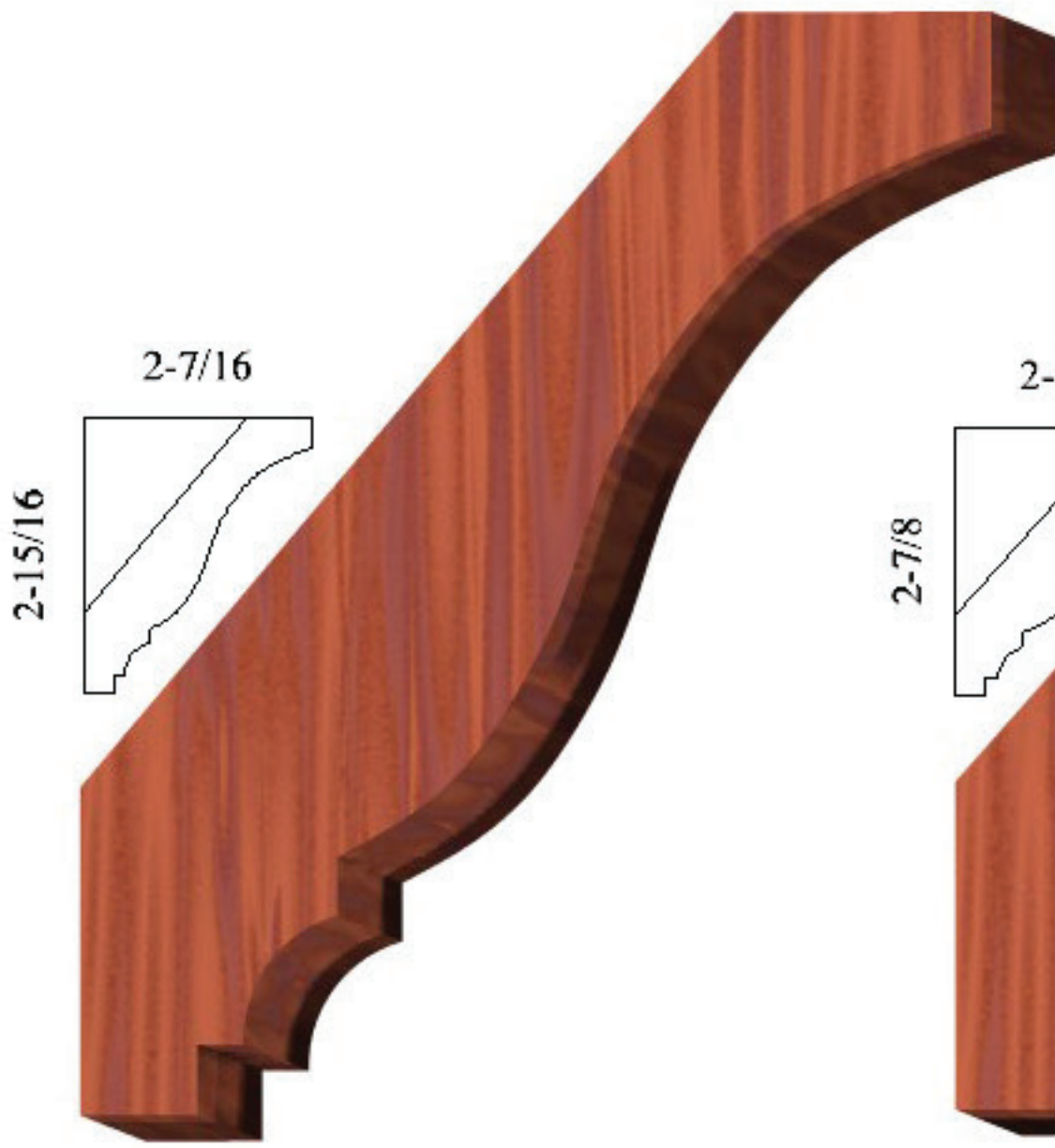

CR120
3/4 x 3-13/16

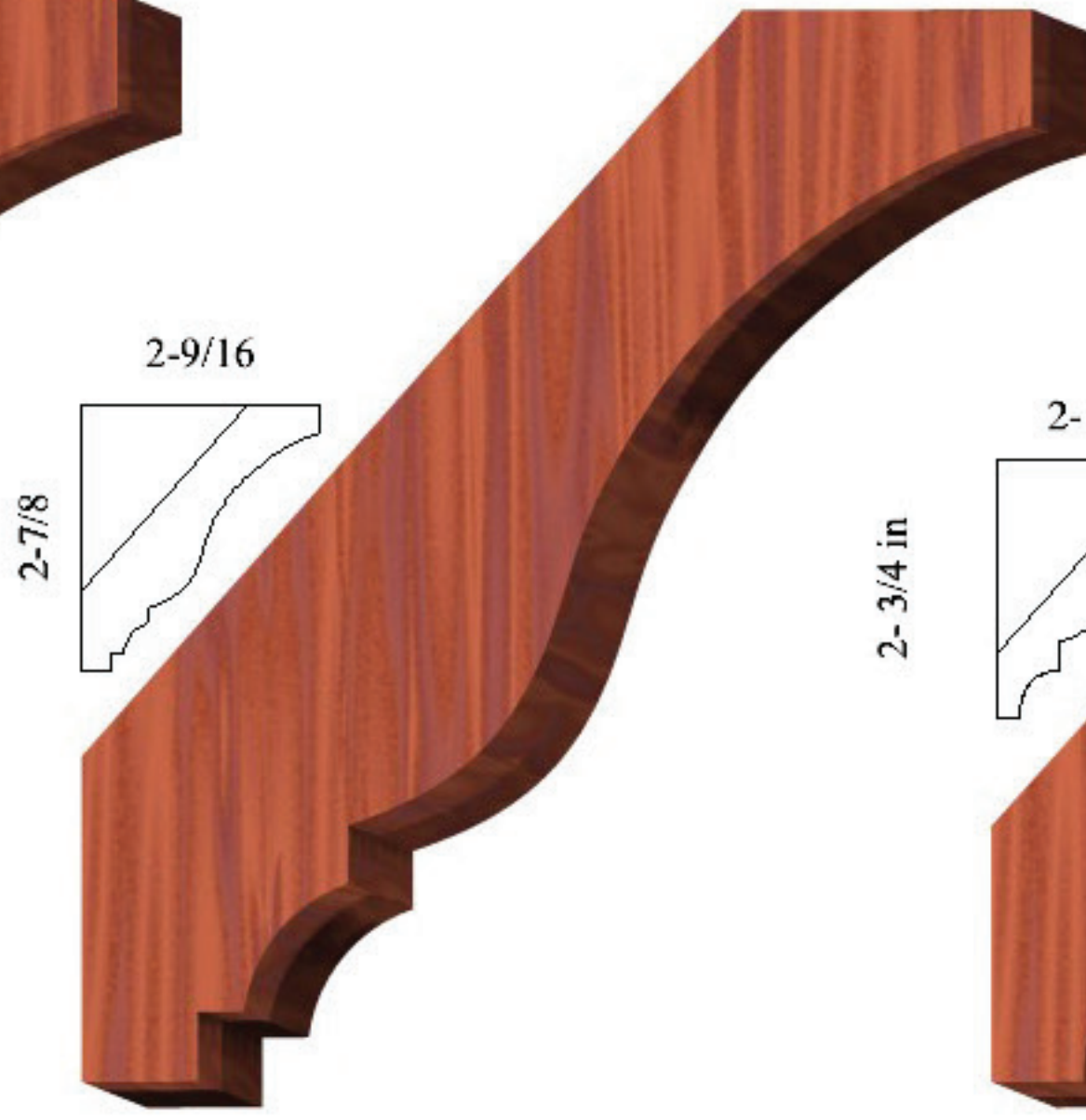

CR127
3/4 x 3-1/4

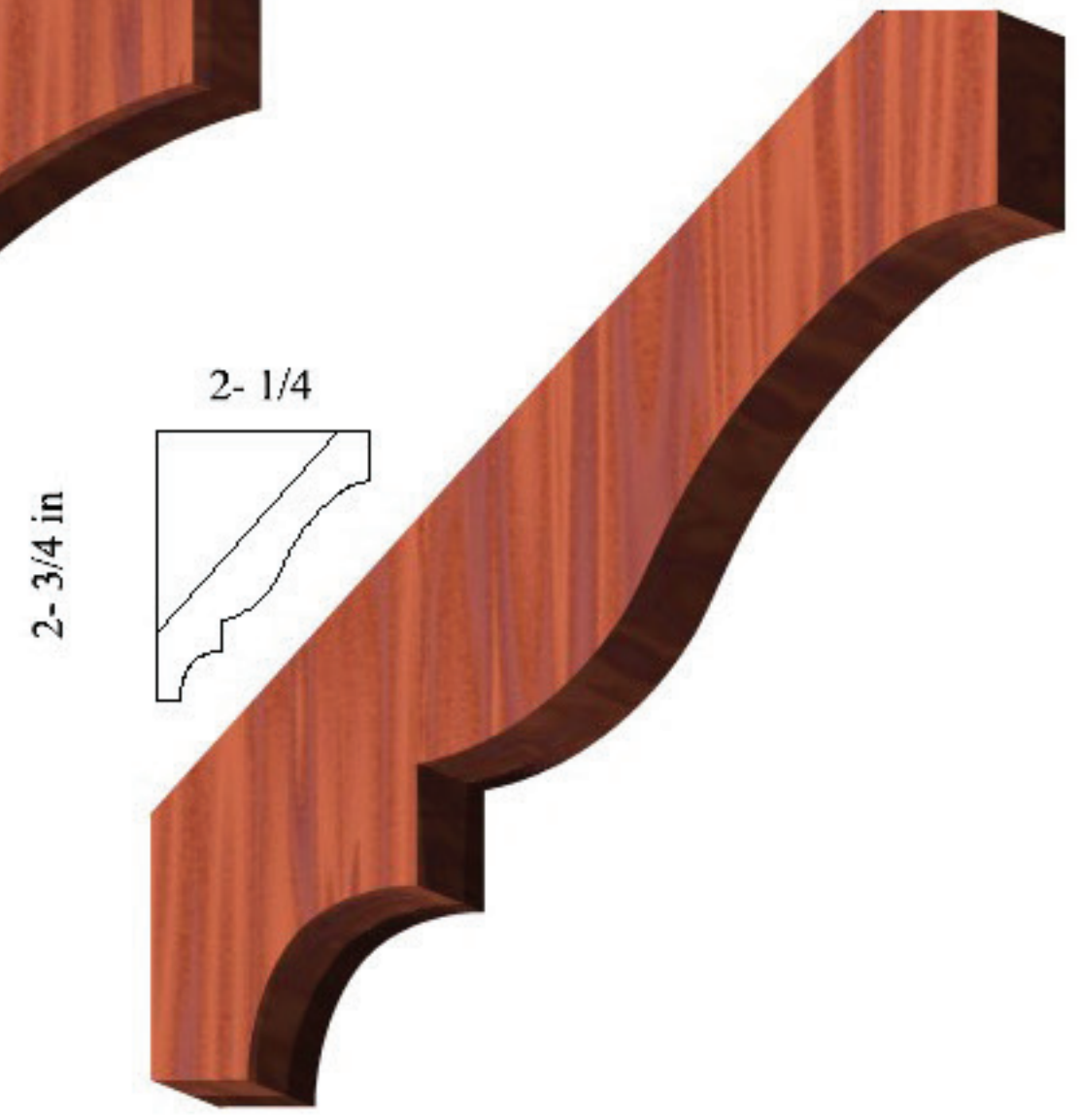

CR 31
3/4 x 3- 5/8

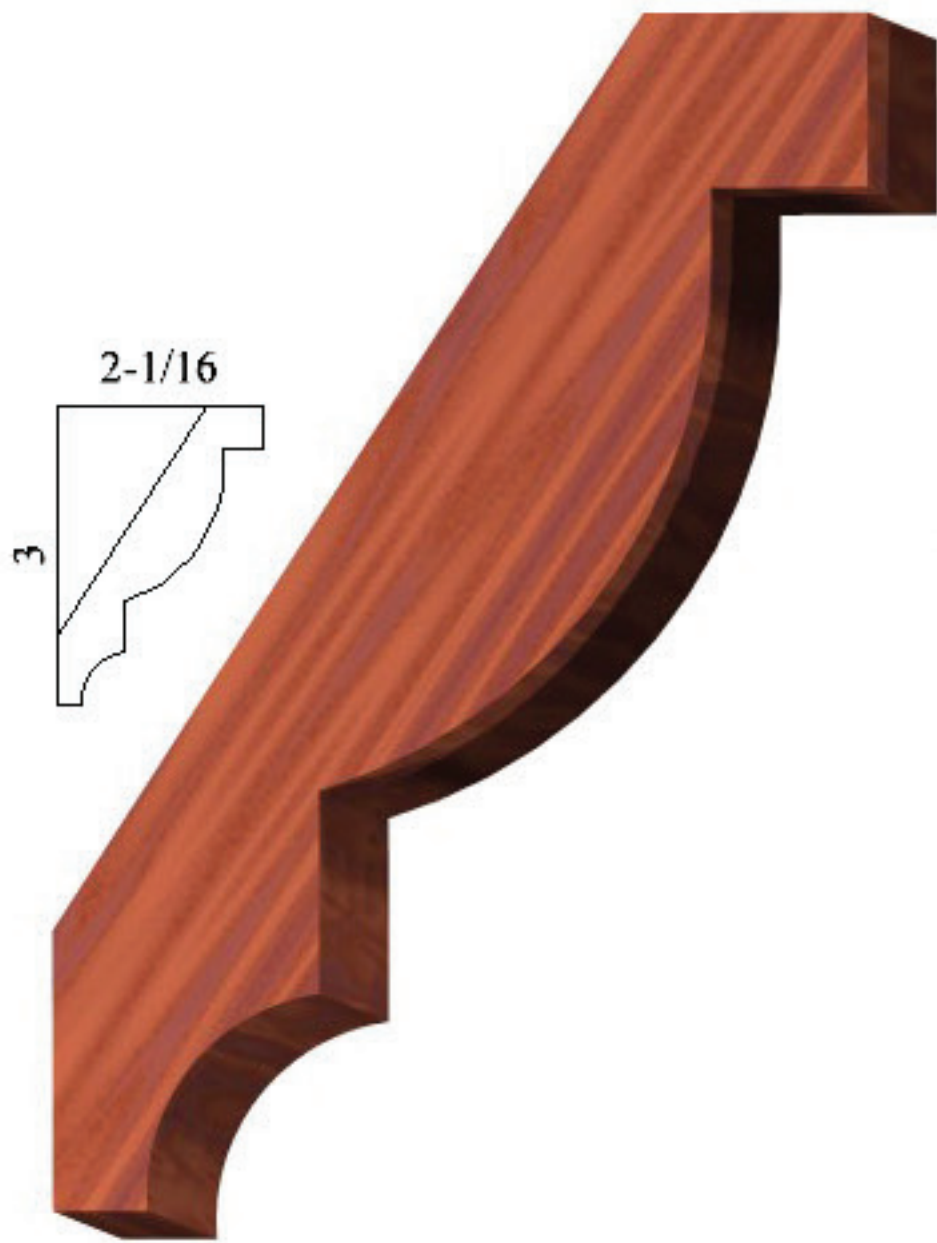

CR232
3/4 x 3-3/4

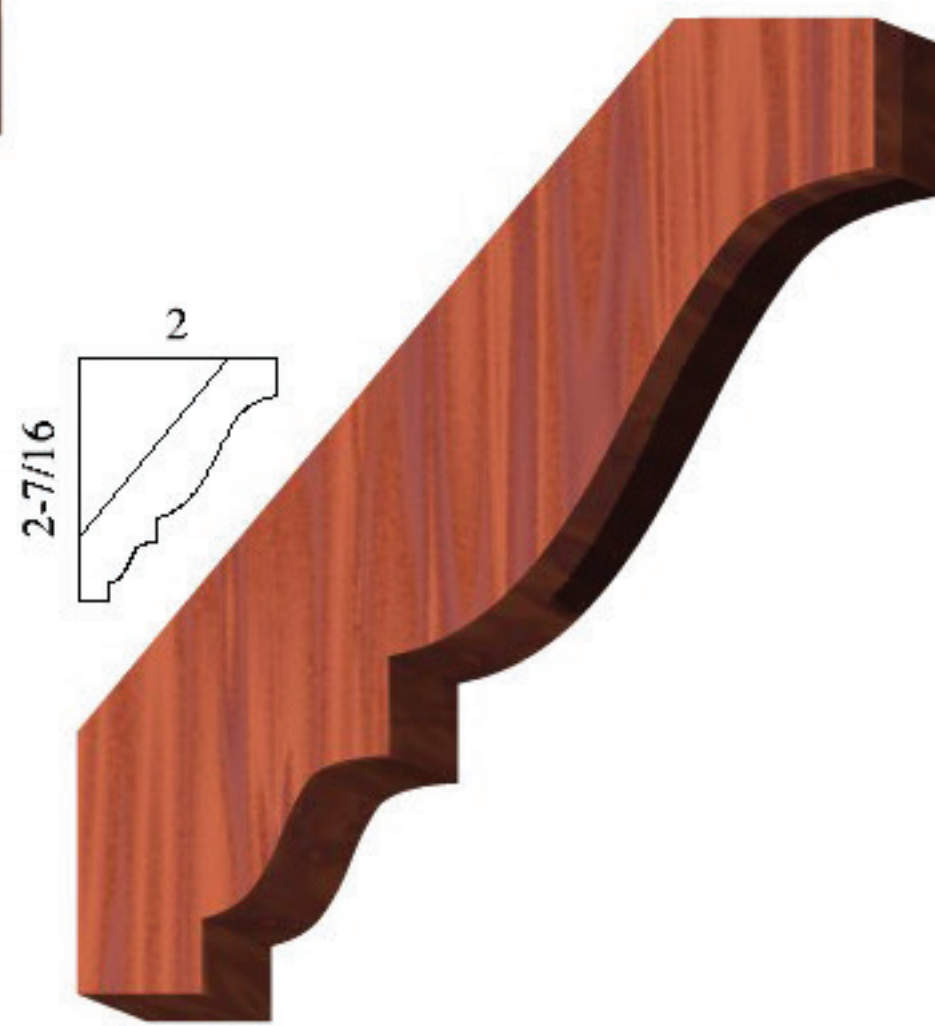

CR56
11/16 x 3-3/8

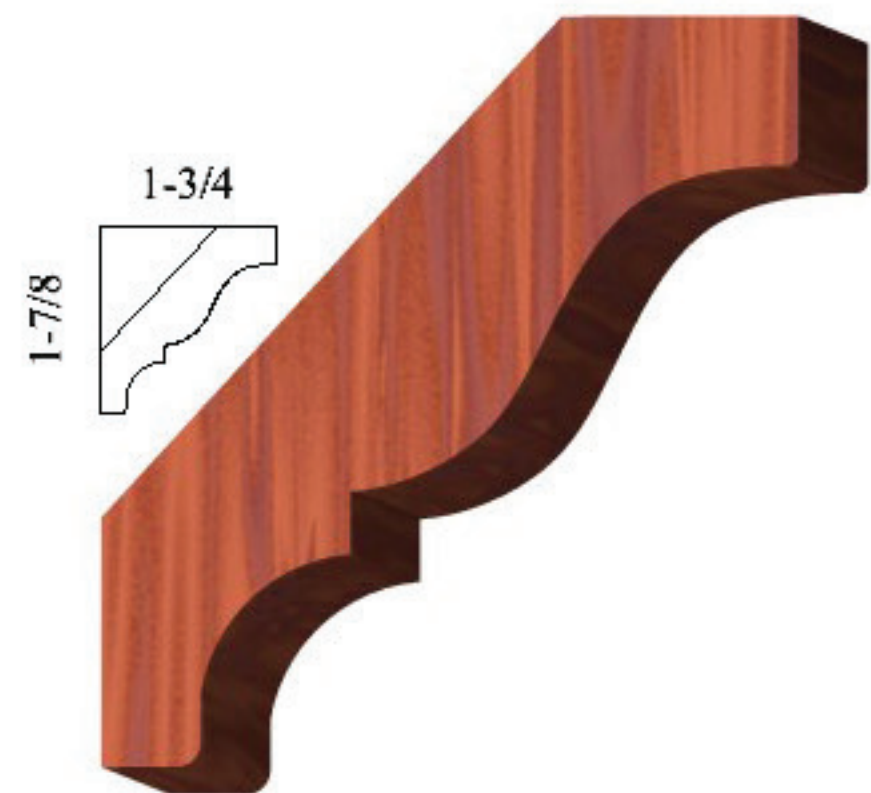

CR64
1/2 x 2-9/16



CR14
1 x 1-3/4



CR17
1-1/4 x 2



CR59
15/16 x 1-5/8



CR05
11/16 x 1-9/16



CR10
3/4 X 1-1/2



CR18
3/4 x 1-11/16



CR61
15/16 x 1-13/16



CR19
3/4 x 1-1/2



CR09
7/8 x 1-1/8



CR13
3/4 x 1-1/16



CR15
3/4 x 1-1/16



CR06
3/4 x 1-1/16



CR21
5/8 x 7/8



CR22
1-1/2 x 3-1/4



CR26
1-3/4 x 2-7/8



CR07
1-1/4 x 2-3/16



CR168
1-7/16 x 2-1/2



CR208
1-3/4 x 3-1/4



CR82
1-1/16 x 2-3/16



CR165
1-7/8 x 3-3/16



CR166
1-3/4 x 1-7/8



CR172
3/4 x 1-3/4



CR167
1 x 1-5/16



CR16
1-11/16 x 1-11/16



CR138
1-7/8 x 1-15/16



CR191
1-3/4 x 3



CR151
1-1/8 x 2-3/16



CR227
1-1/16 x 1-3/4



CR103
1-5/8 x 1-5/8



CR126
13/16 x 1-1/4



CR202
3/4 x 3/4



CR209
7/8 x 2-1/2



CR98
1-3/4 x 2



CR212
3/4 x 1-1/2



CR218
13/16 x 15/16

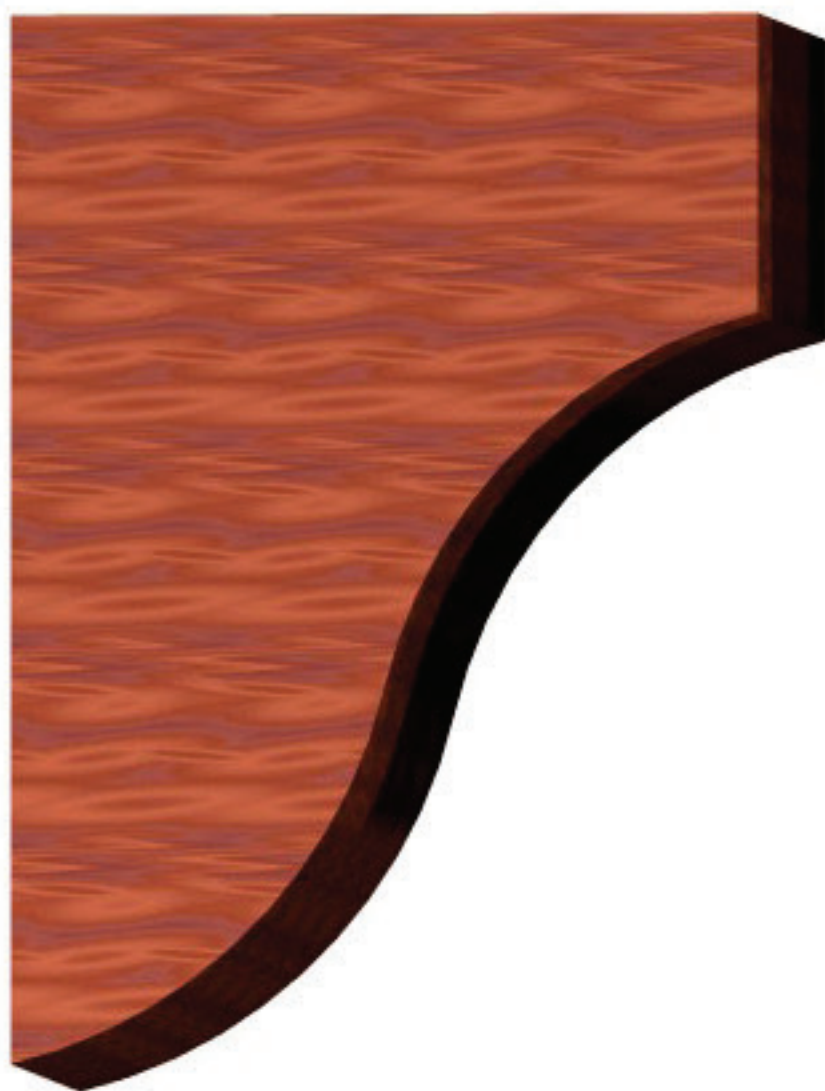

CR231
1-7/8 x 2-5/8

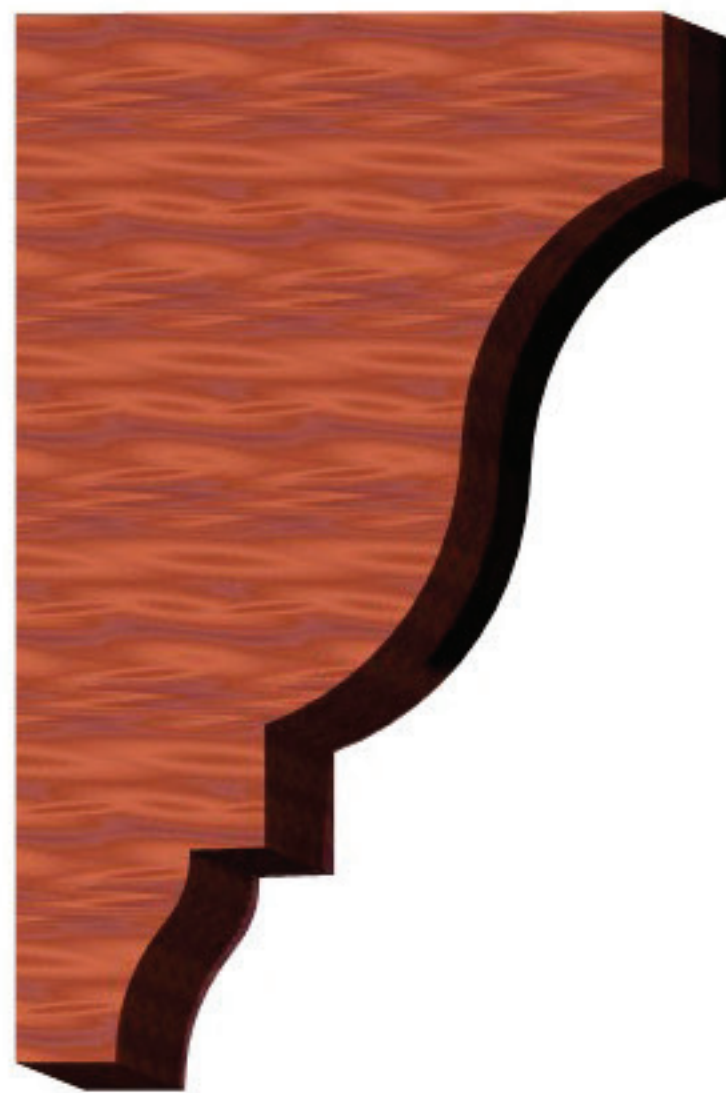

CR222
1-5/8 x 2-5/8

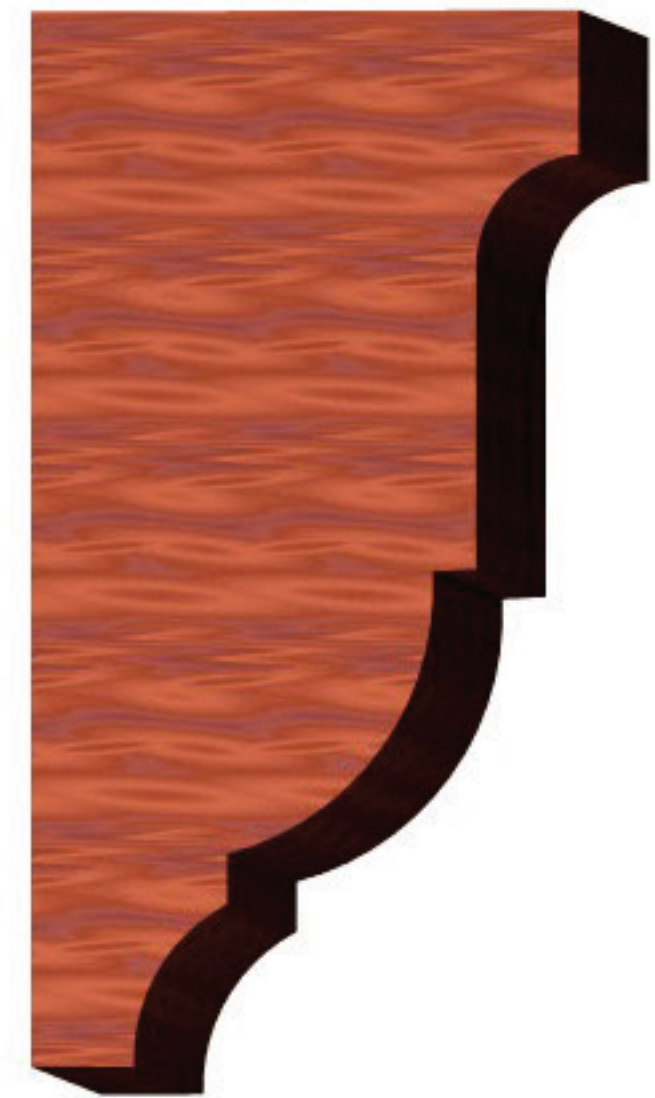

CR225
1-3/8 x 2-5/8

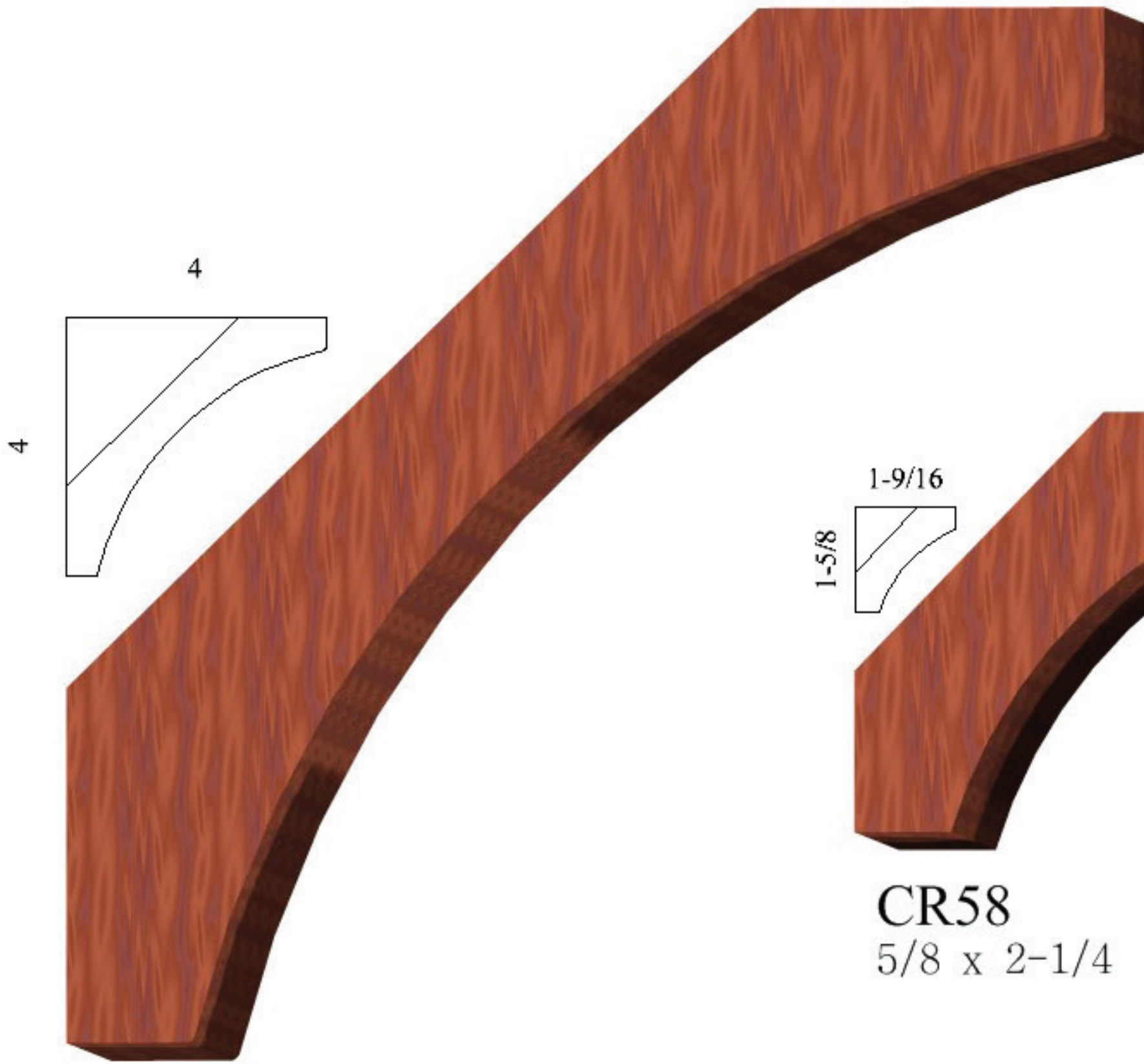

CR 41
1- 3/8 x 5- 3/4

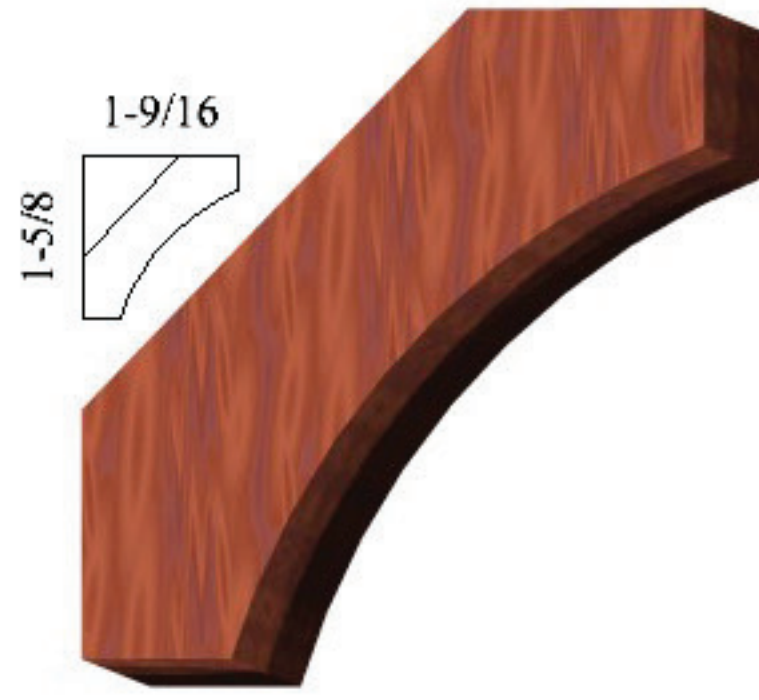

CR58
5/8 x 2-1/4

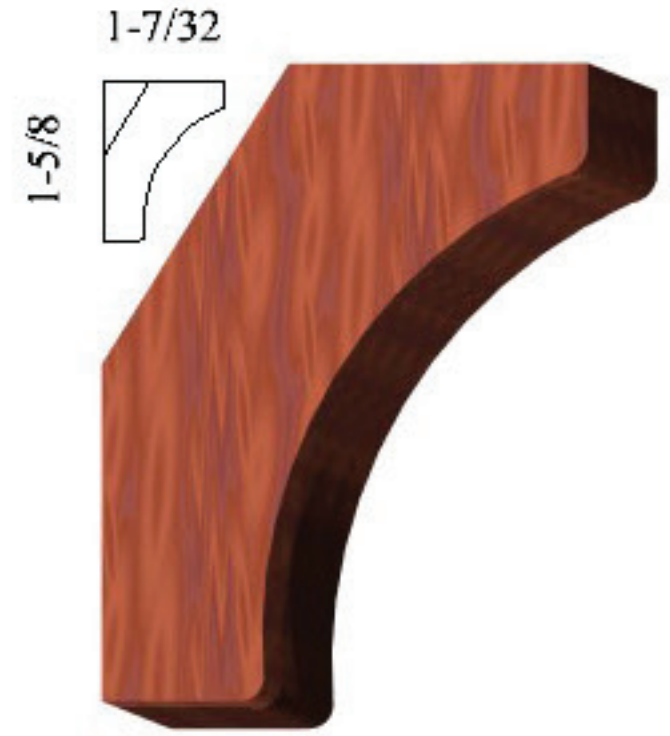

CR99
1/2 x 2

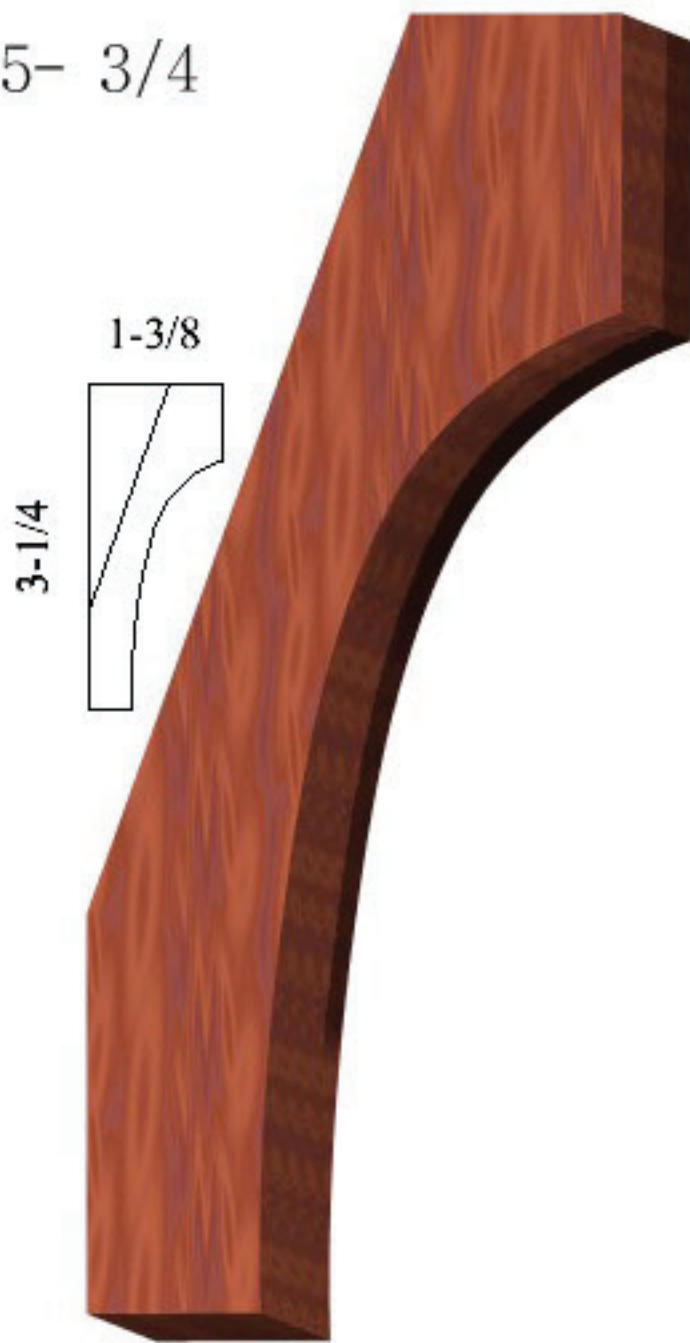

CR150
3/4 X 3-1/2

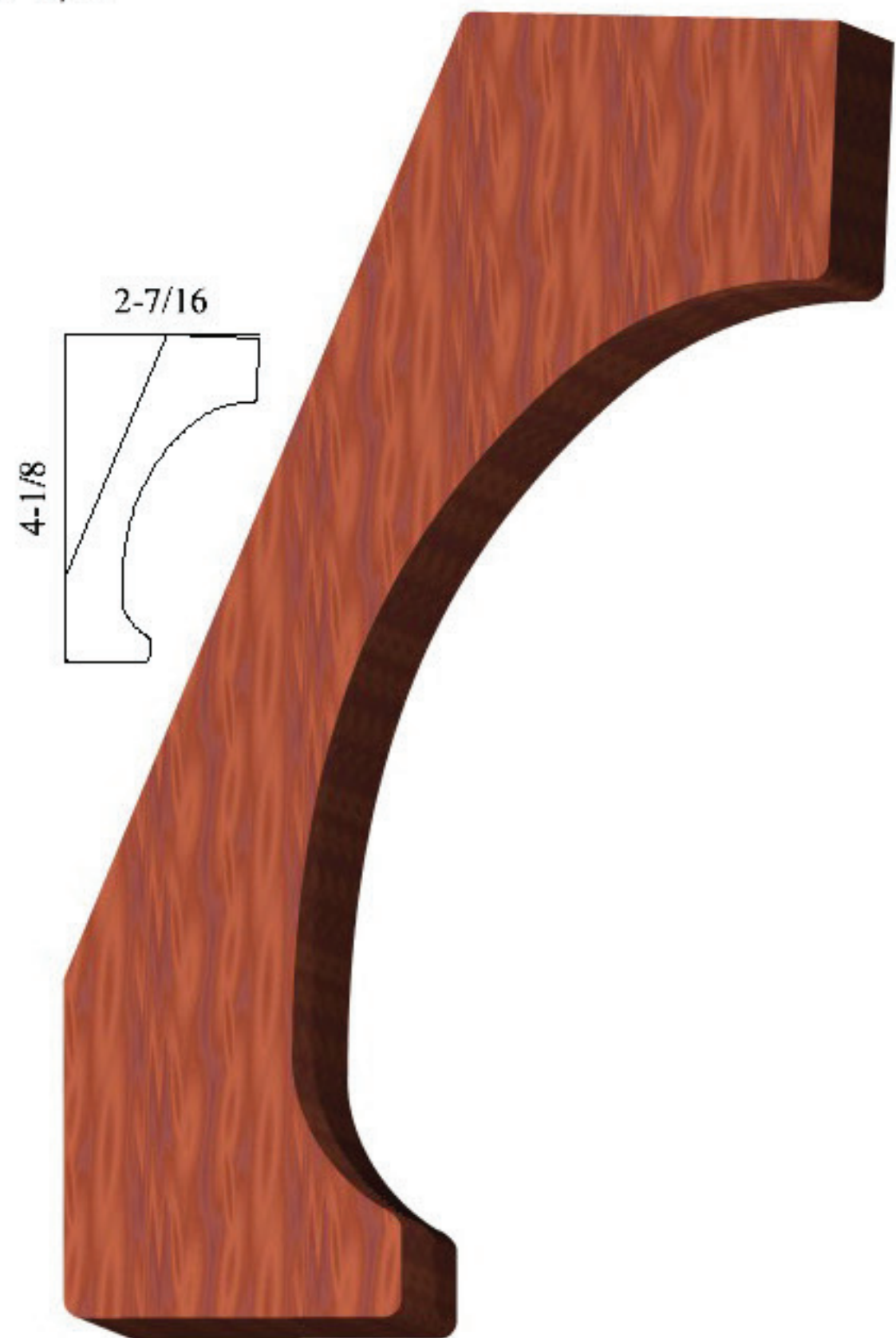

CR80
1-3/8 x 4-11/16

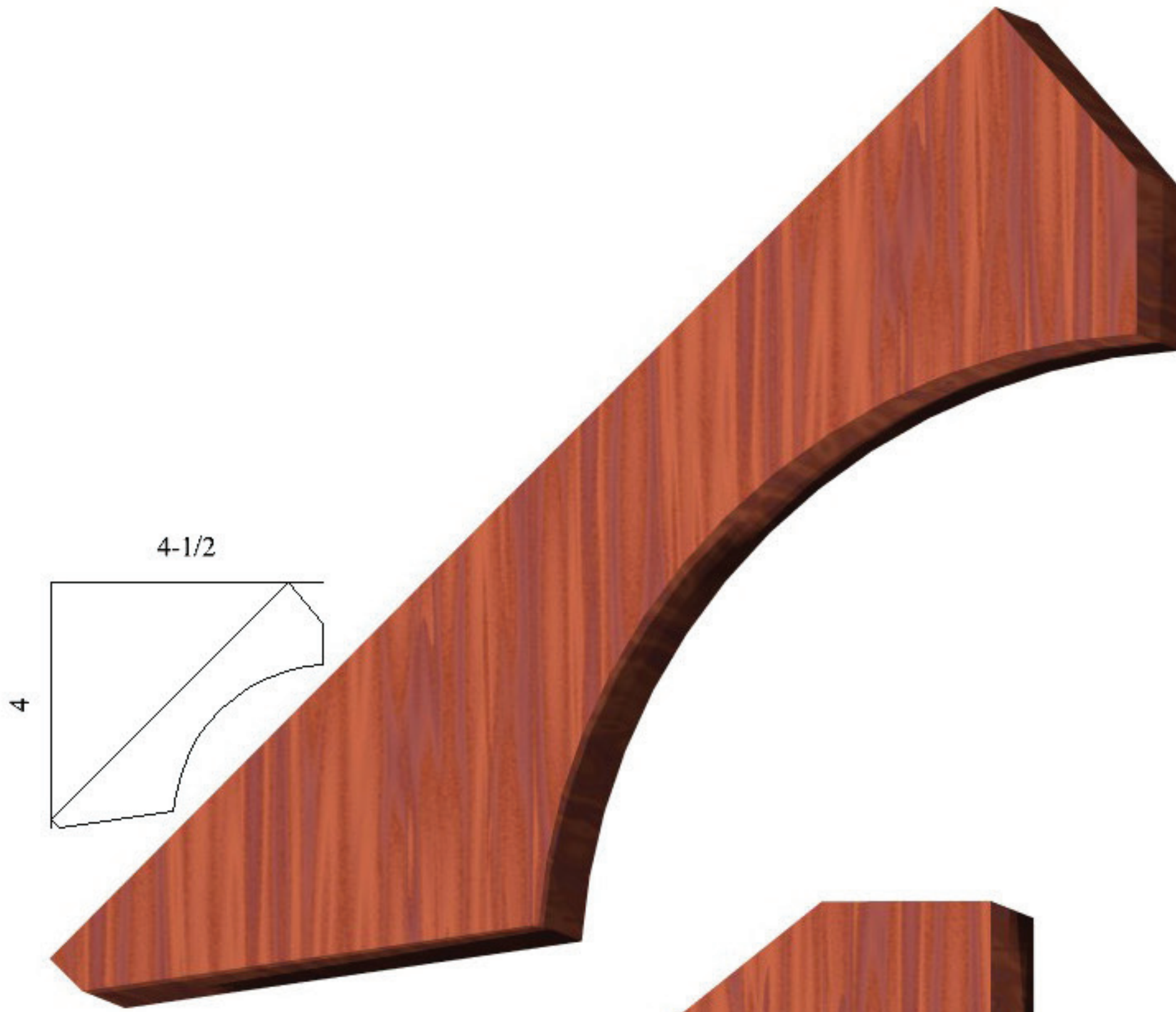

CR67

1-5/16 x 5-1/2

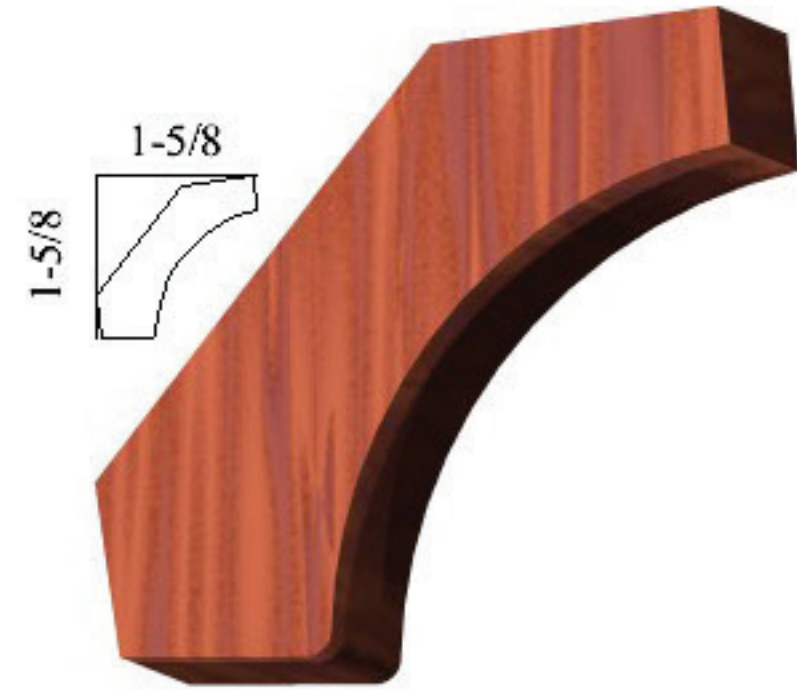
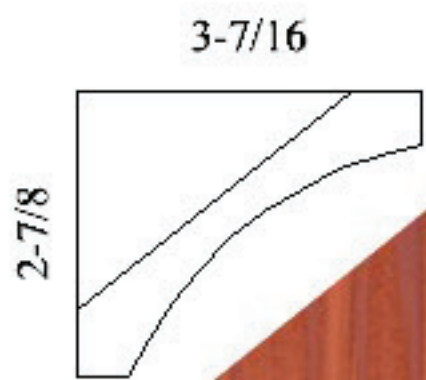

CR97

3/4 x 2-1/4

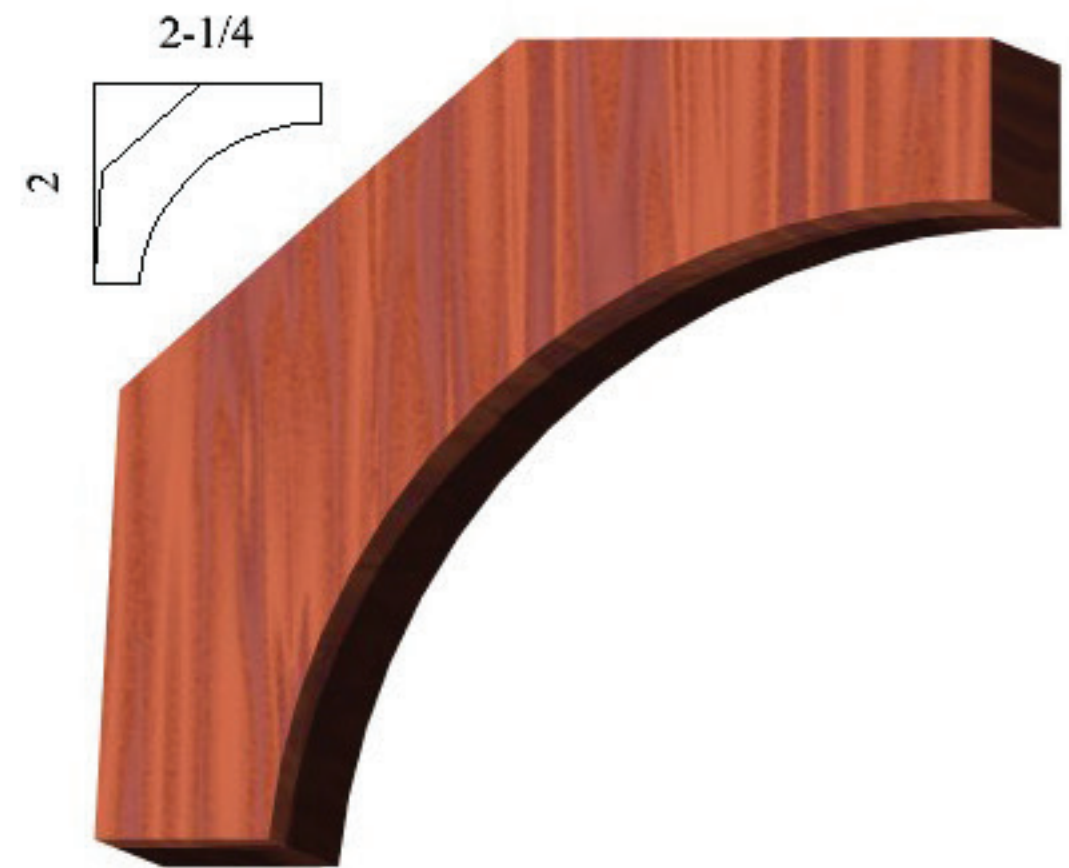

CR147

1-1/8 x 3



CR200

7/8 x 4-1/2

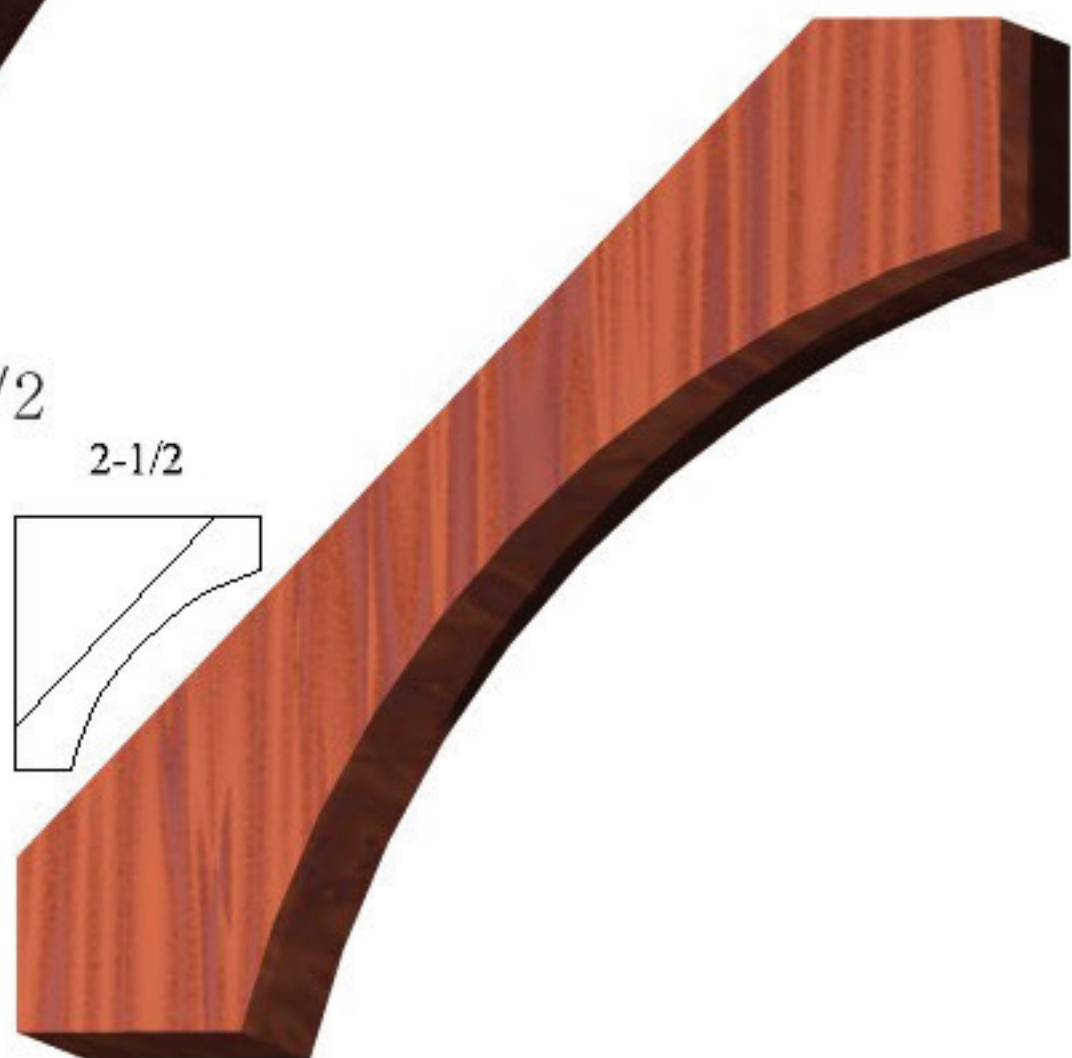
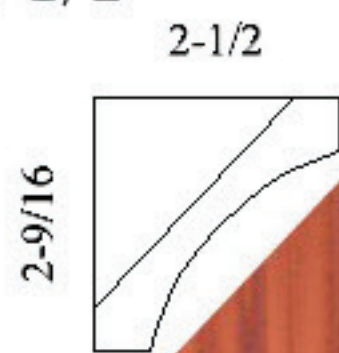

CR95

3/4 x 3-9/16

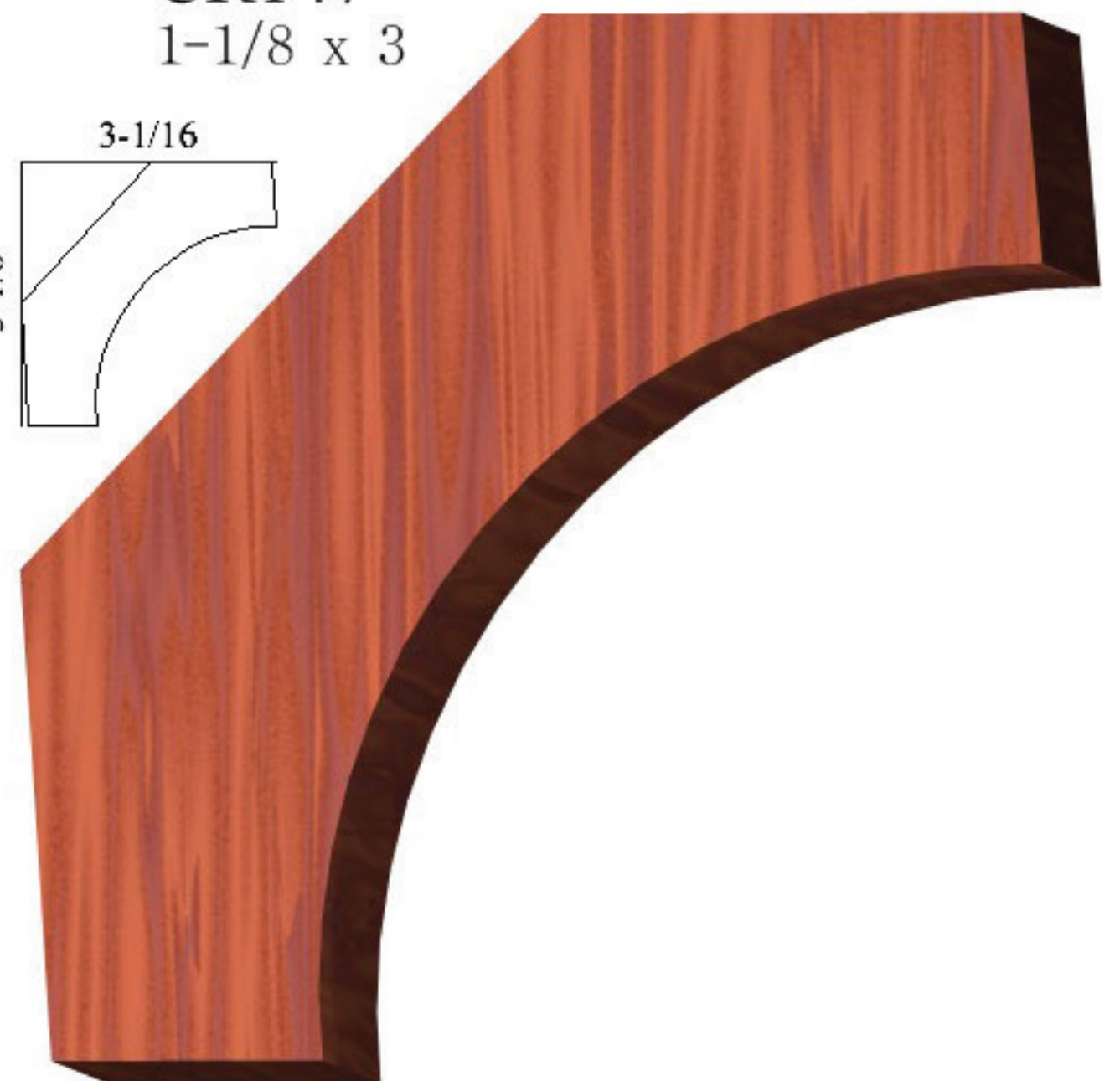

CR210

1-1/2 x 4-5/16

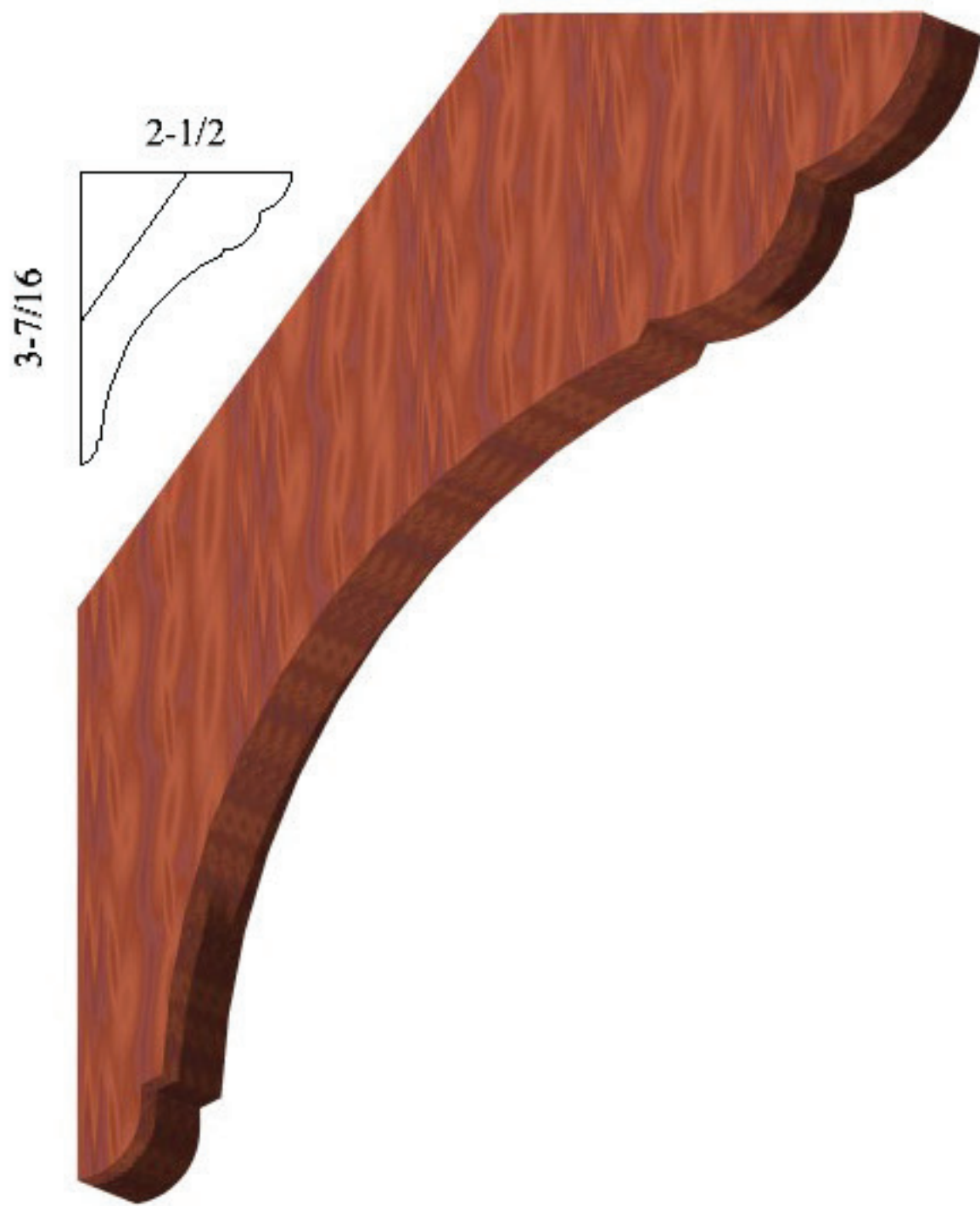

CR44
1-1/16 x 4-1/4

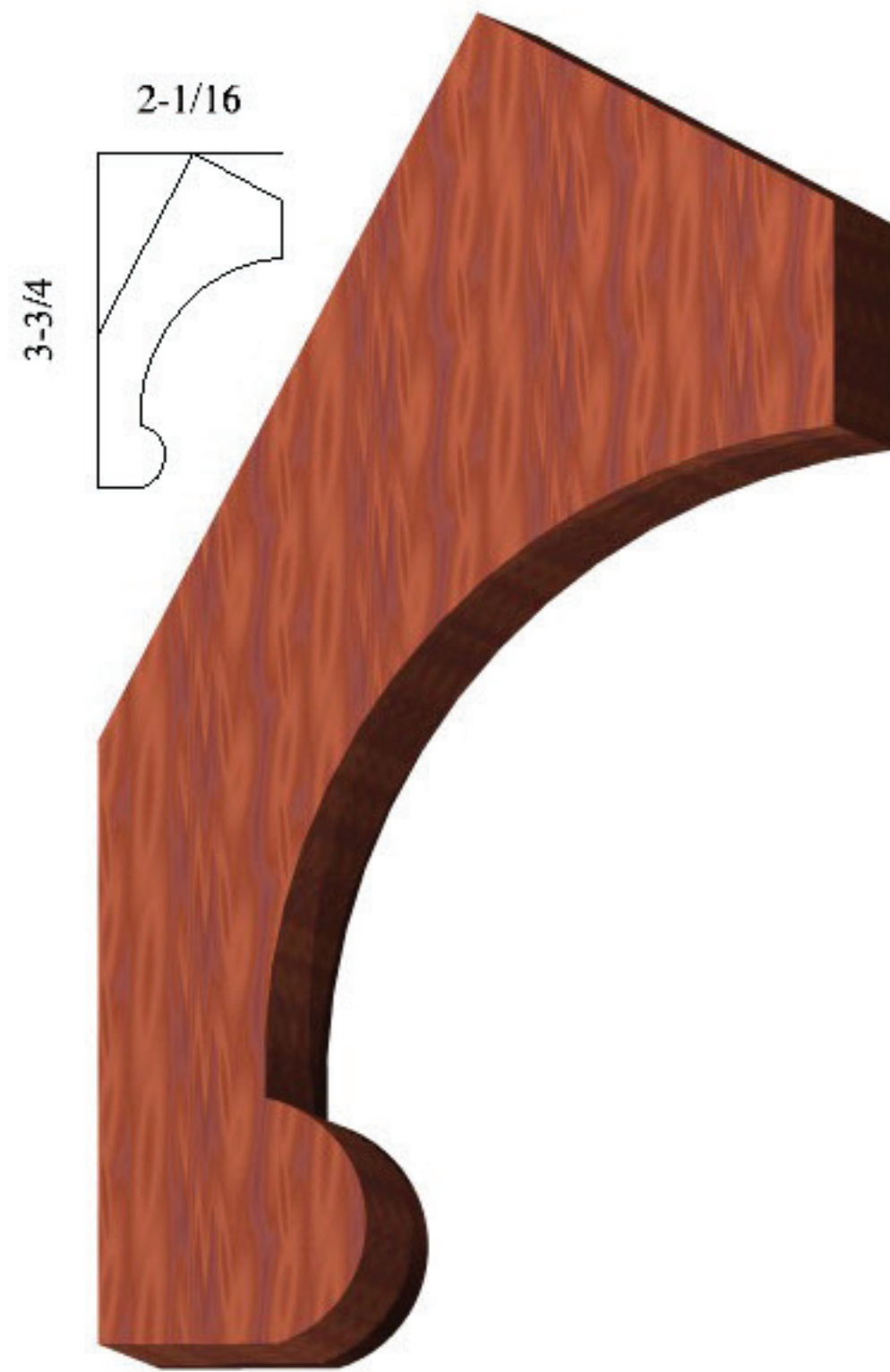

CR140
1-3/8 x 3-7/8

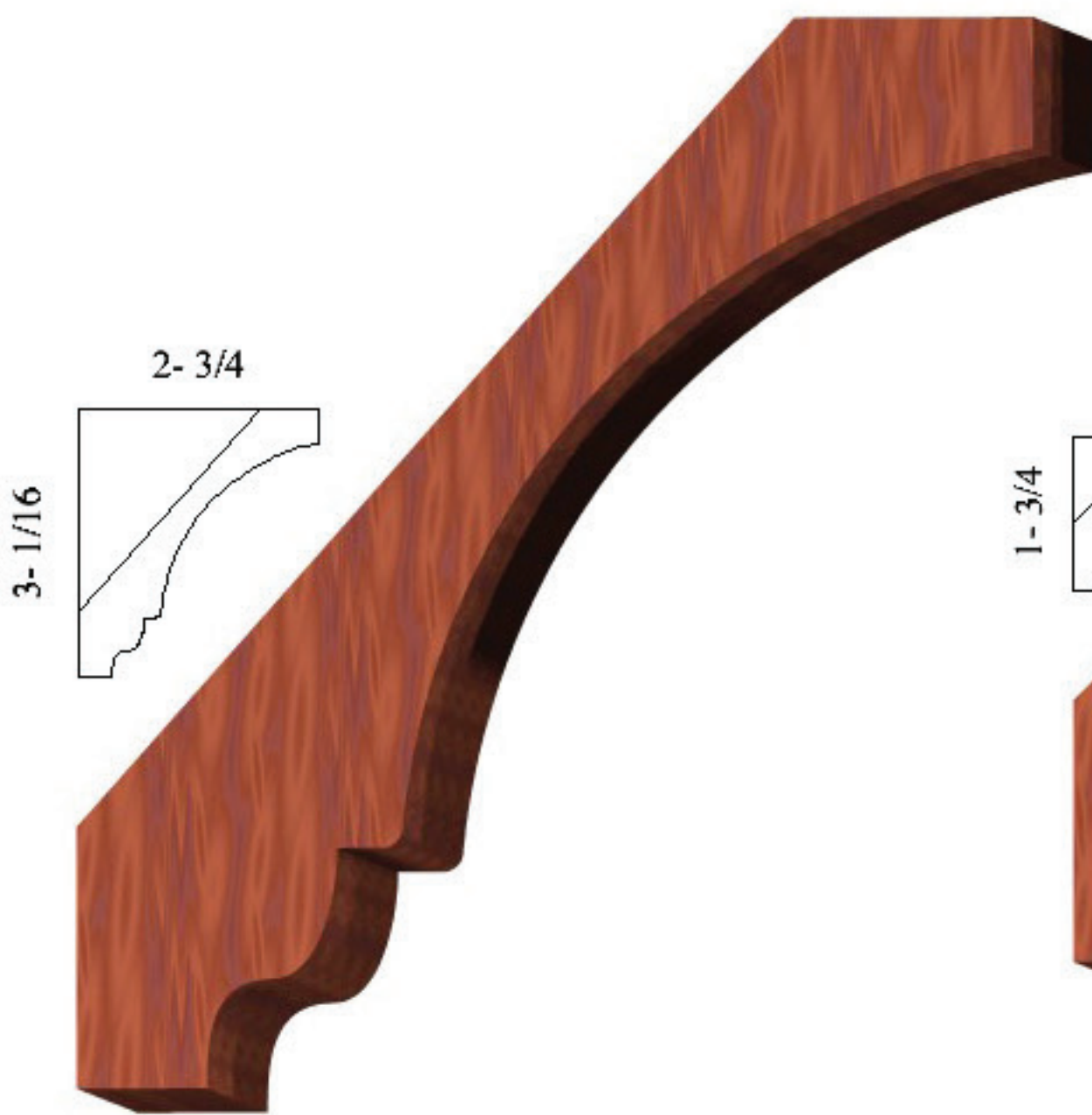

CR 60
3/4 x 4-1/8

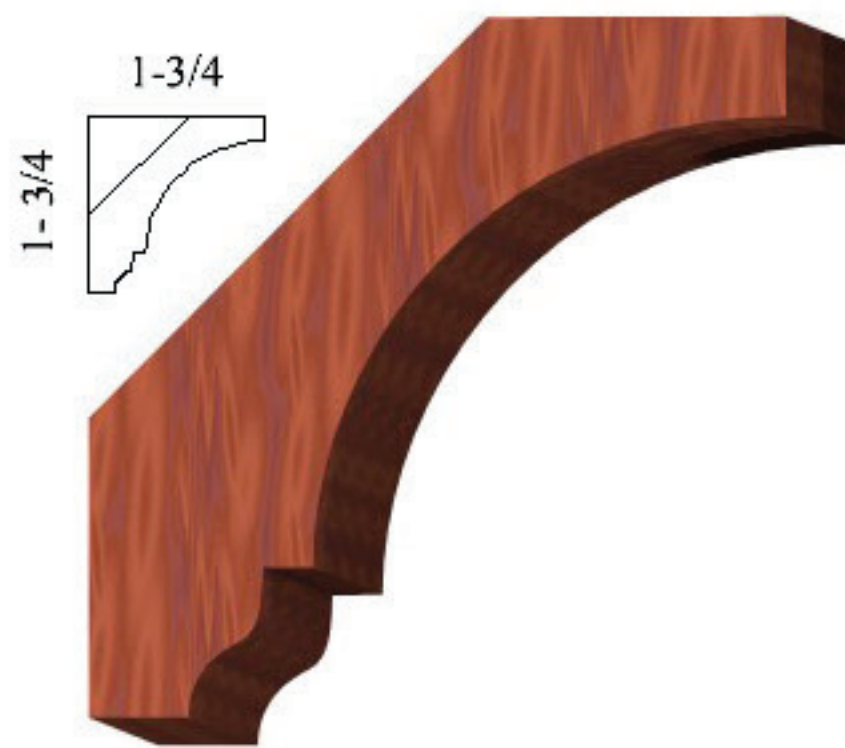

CR 32
3/4 x 2-1/2

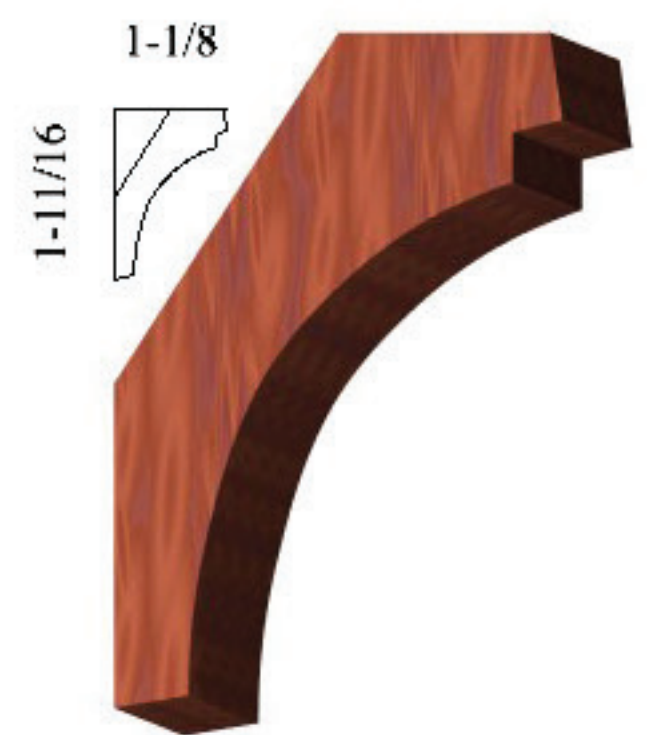

CR25
9/16 x 2

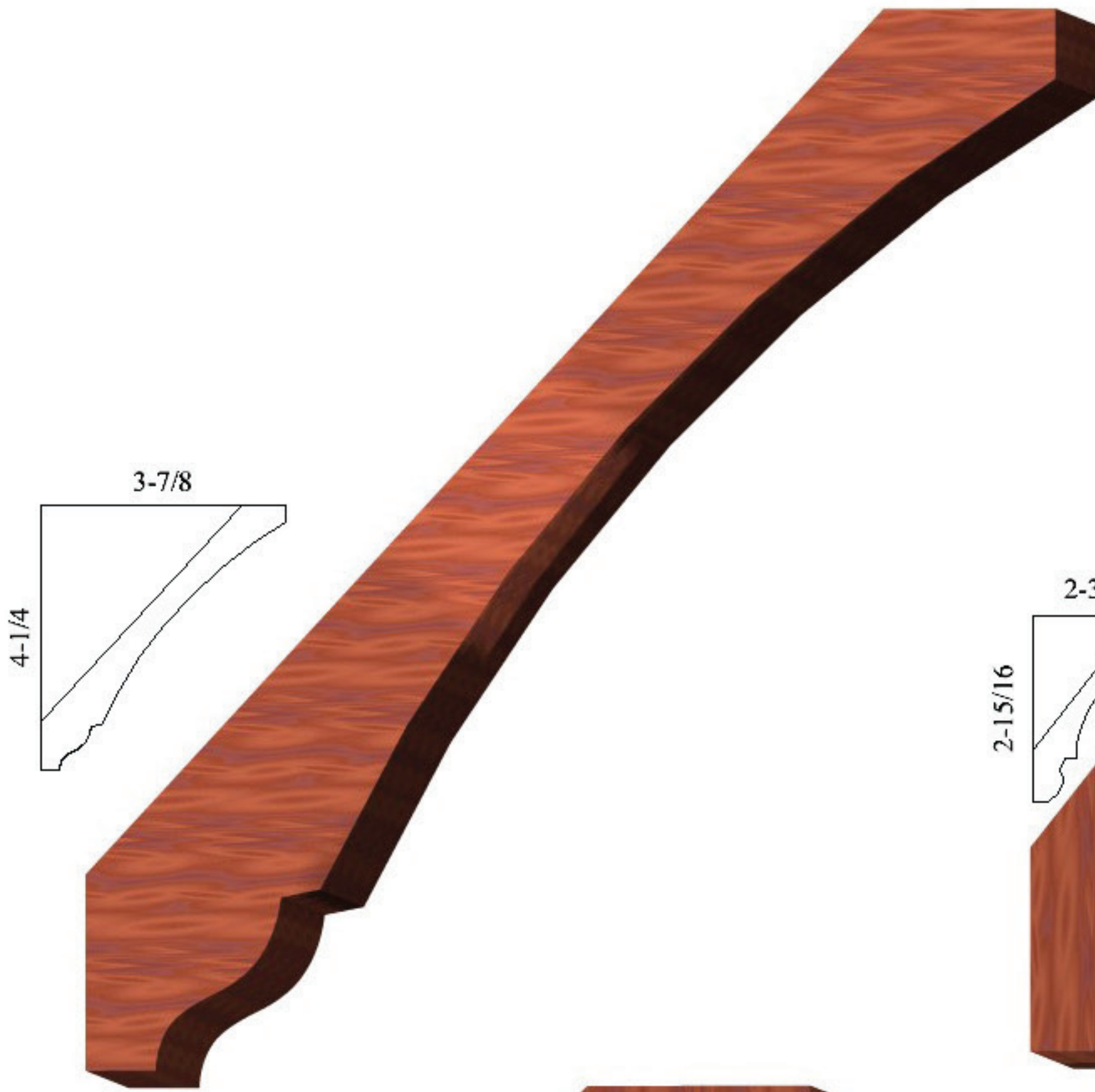

CR142
3/4 x 5-3/4

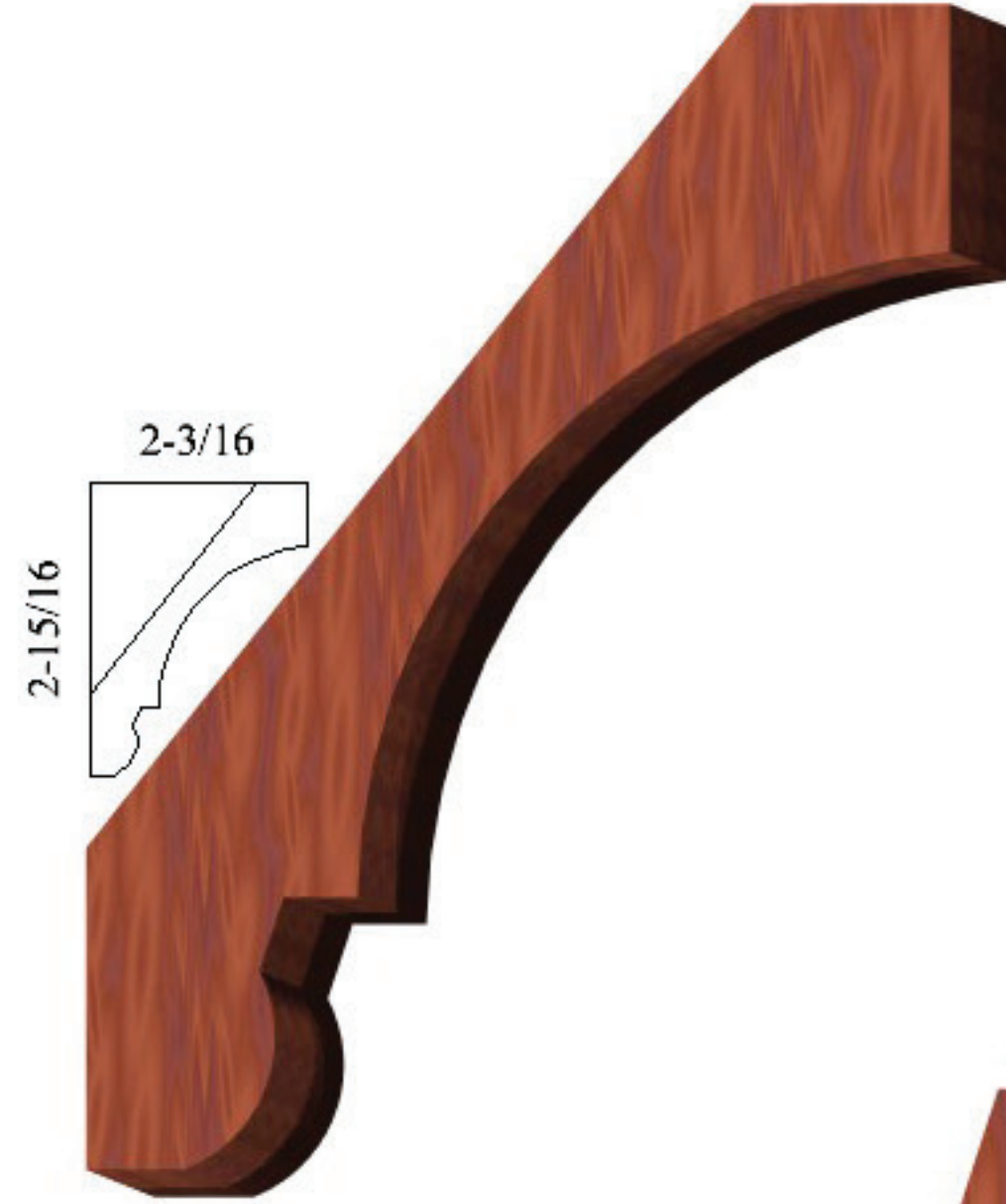

CR194
3/4 x 3-5/8

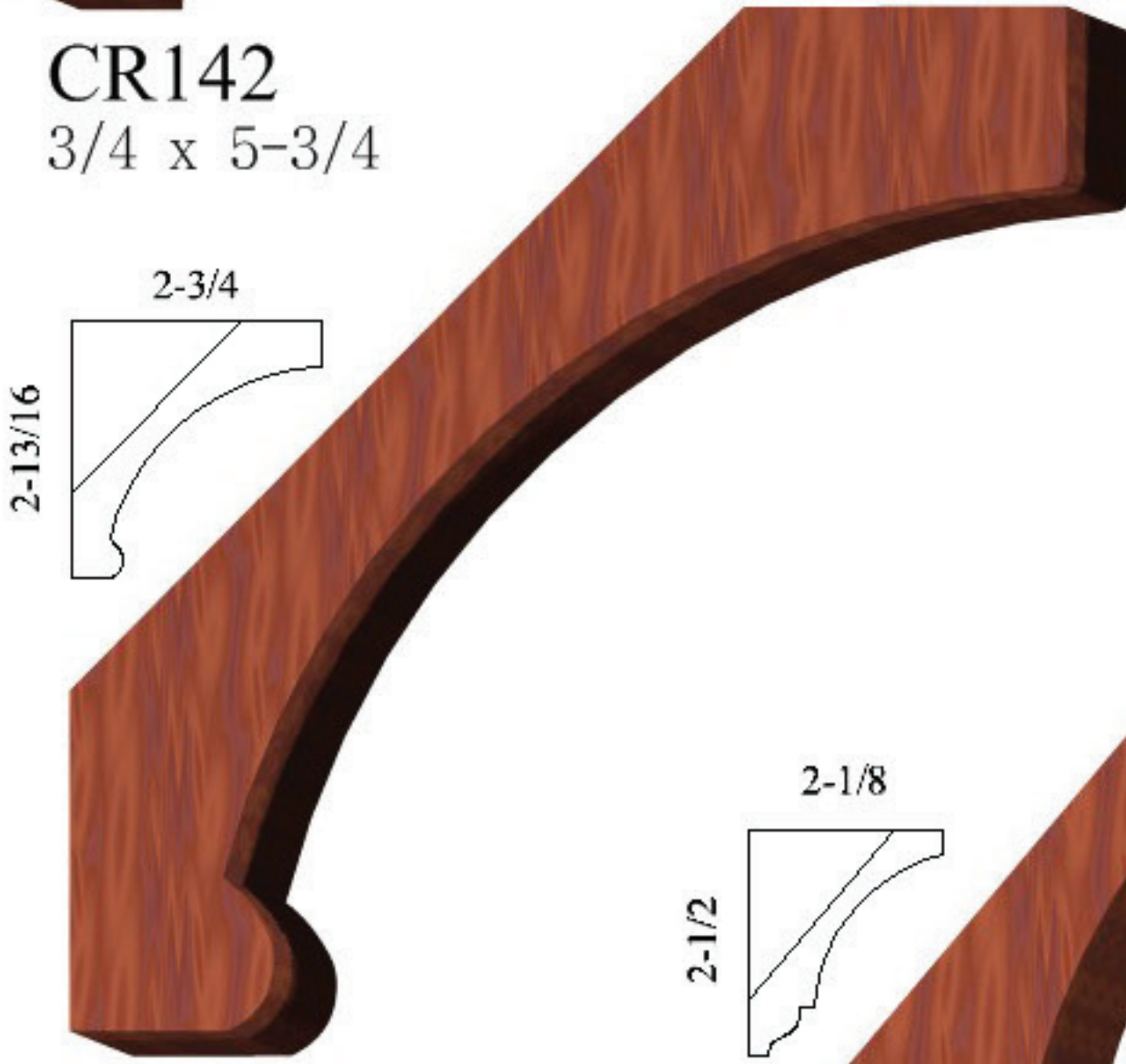

CR184
1 x 3-15/16

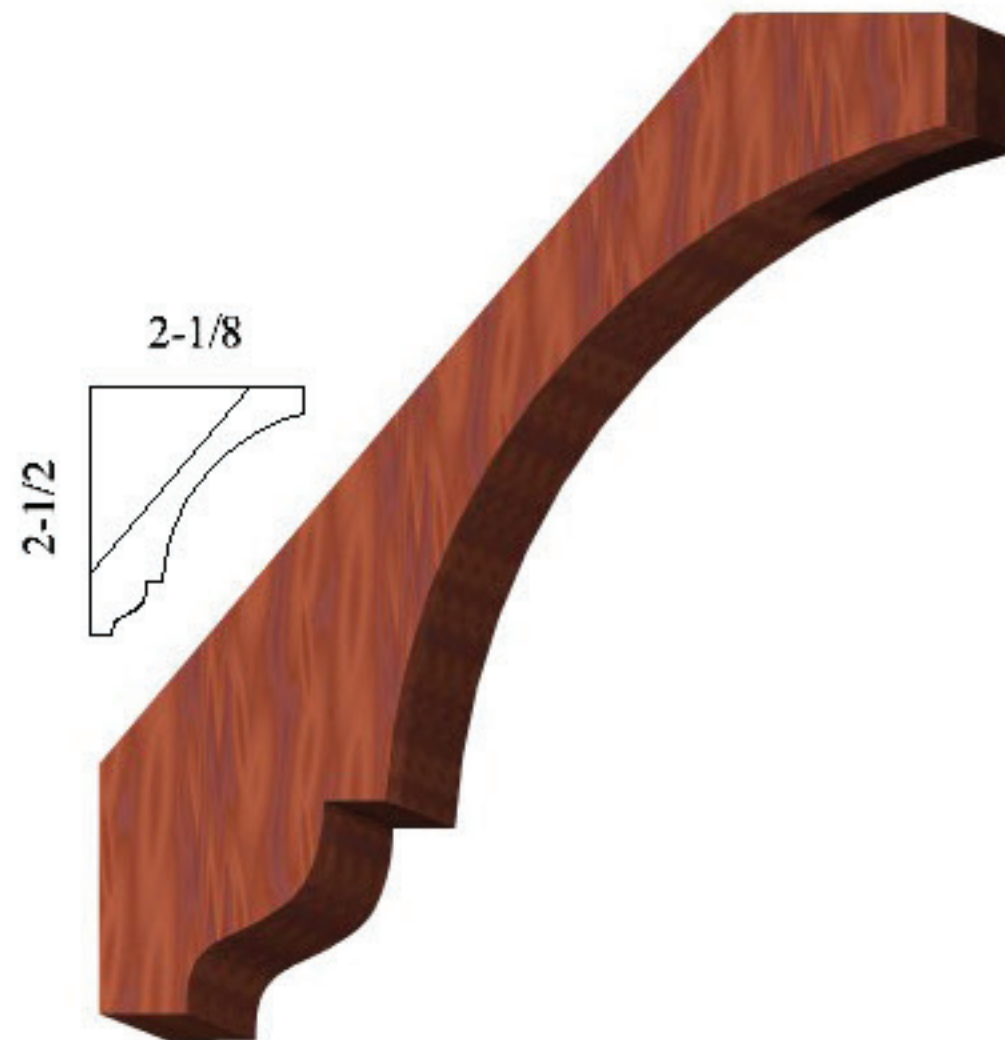

CR158
3/4 x 3-5/16

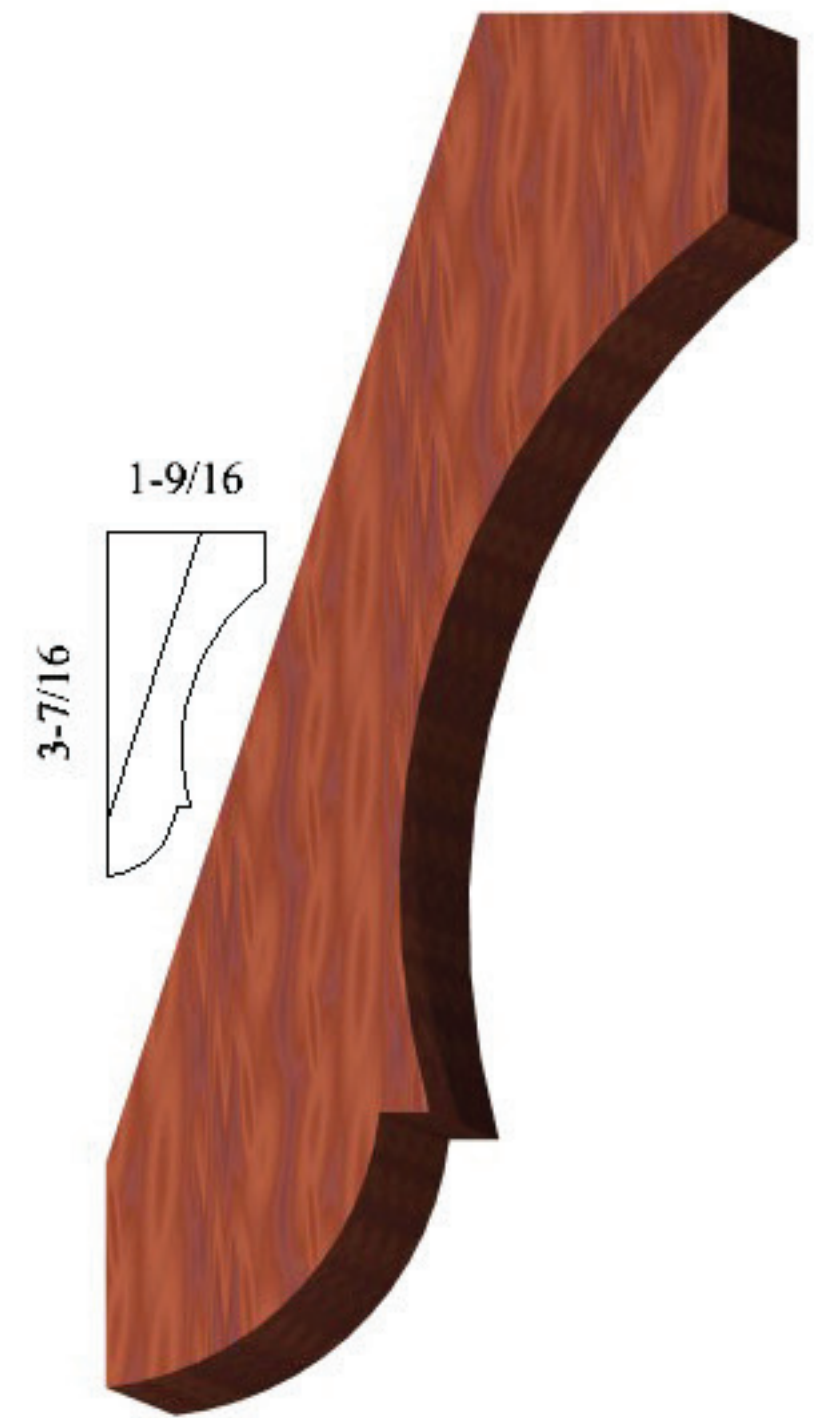

CR180
3/4 x 3-13/16

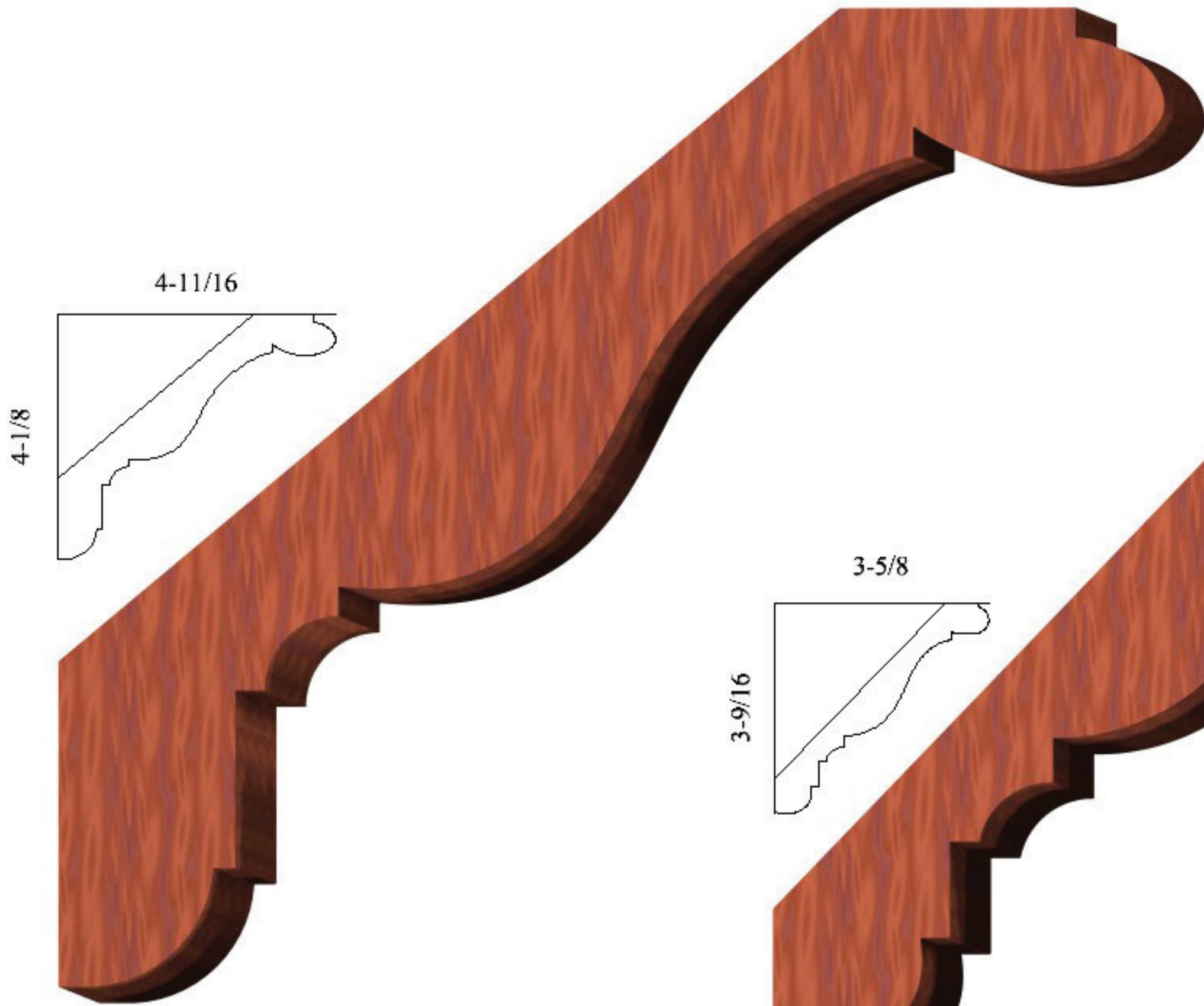

CR04
1-1/4 x 6

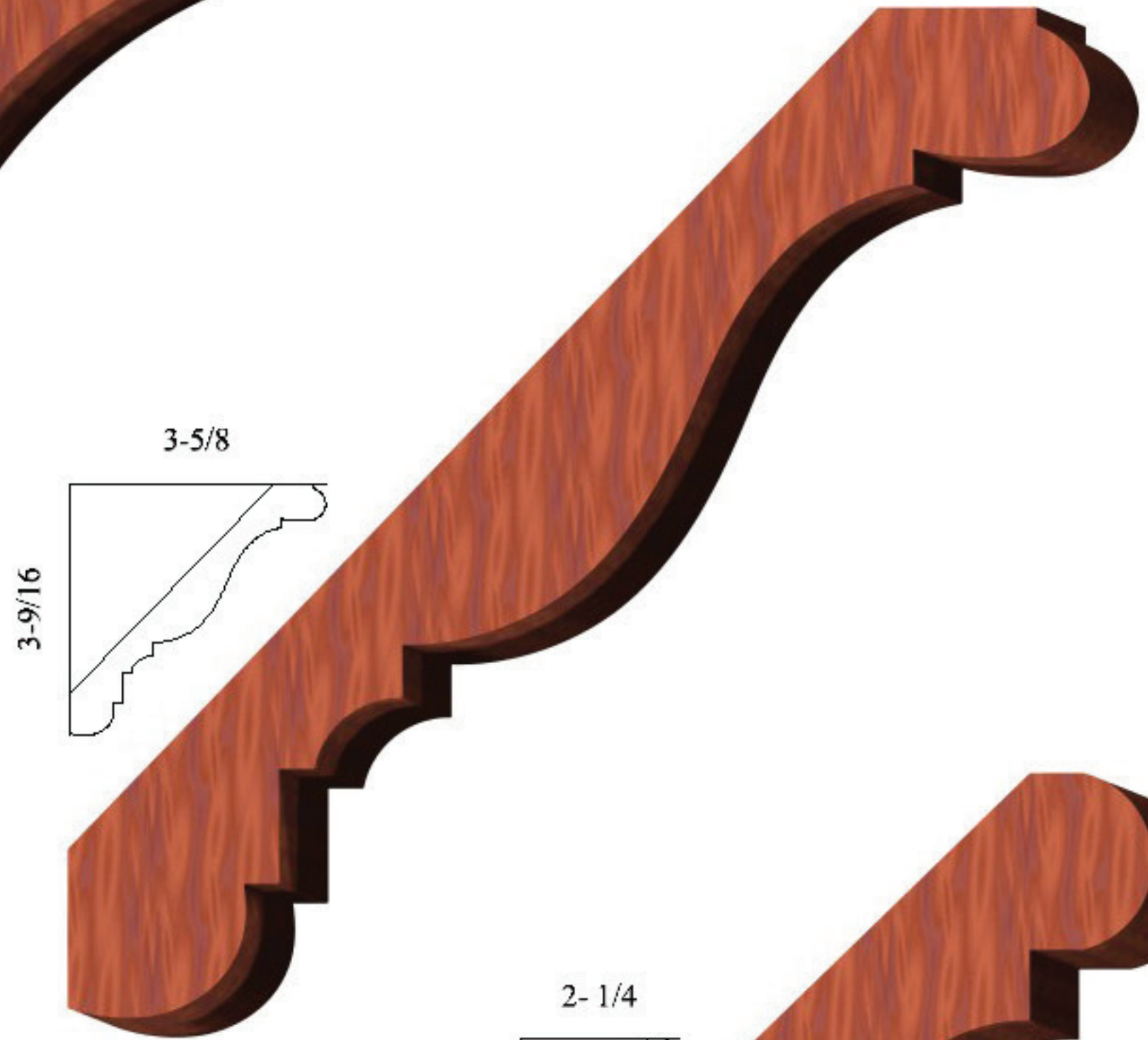

CR42
3/4 x 4-15/16

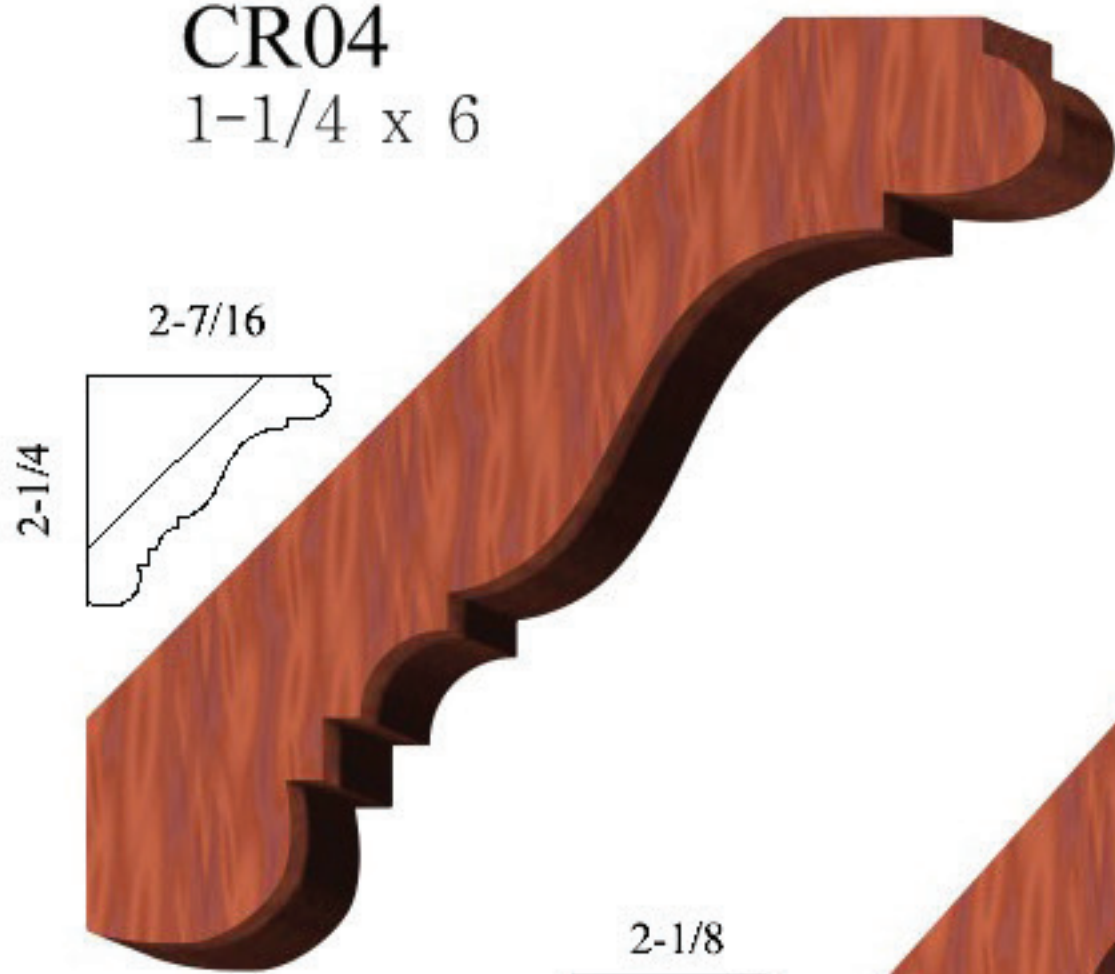

CR43
3/4 x 3-3/16

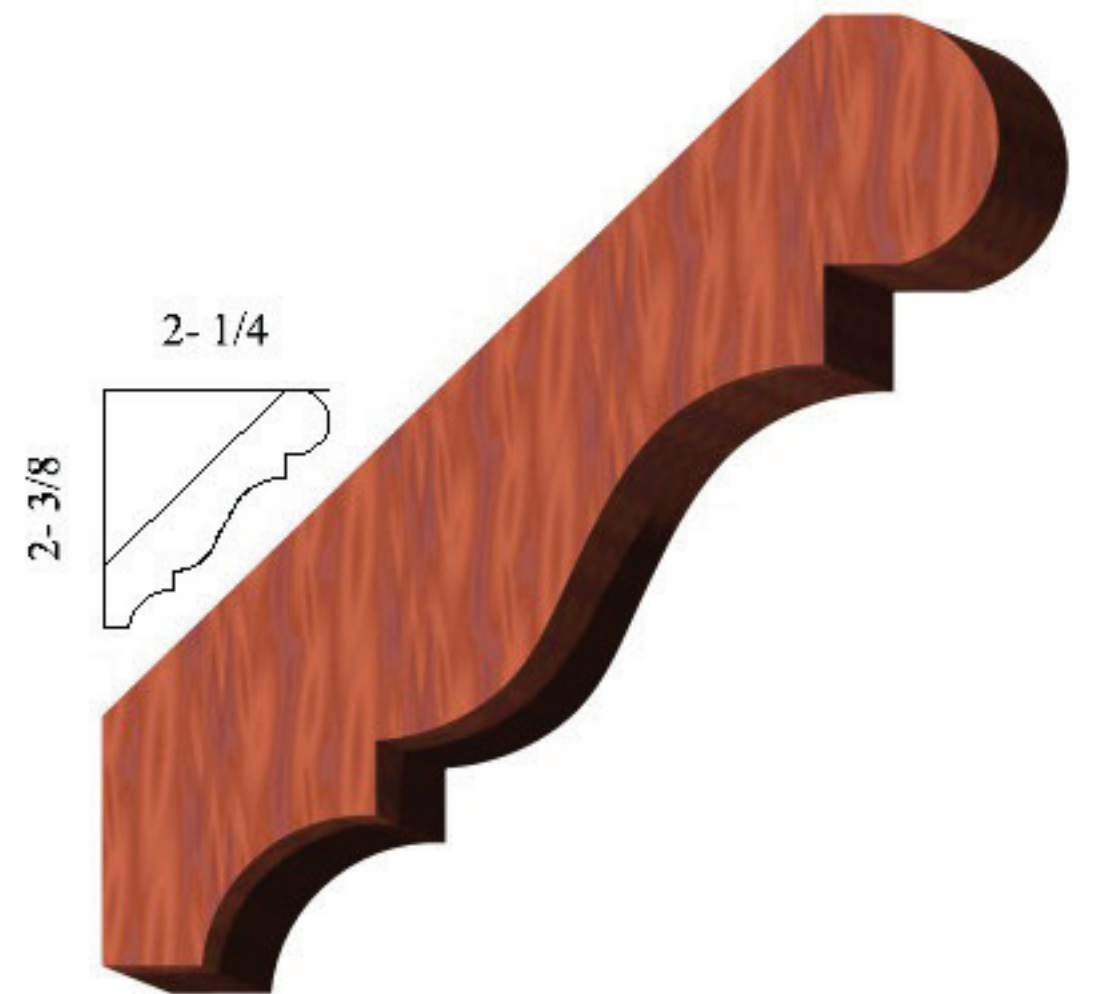

CR 23
11/16 x 3- 1/4

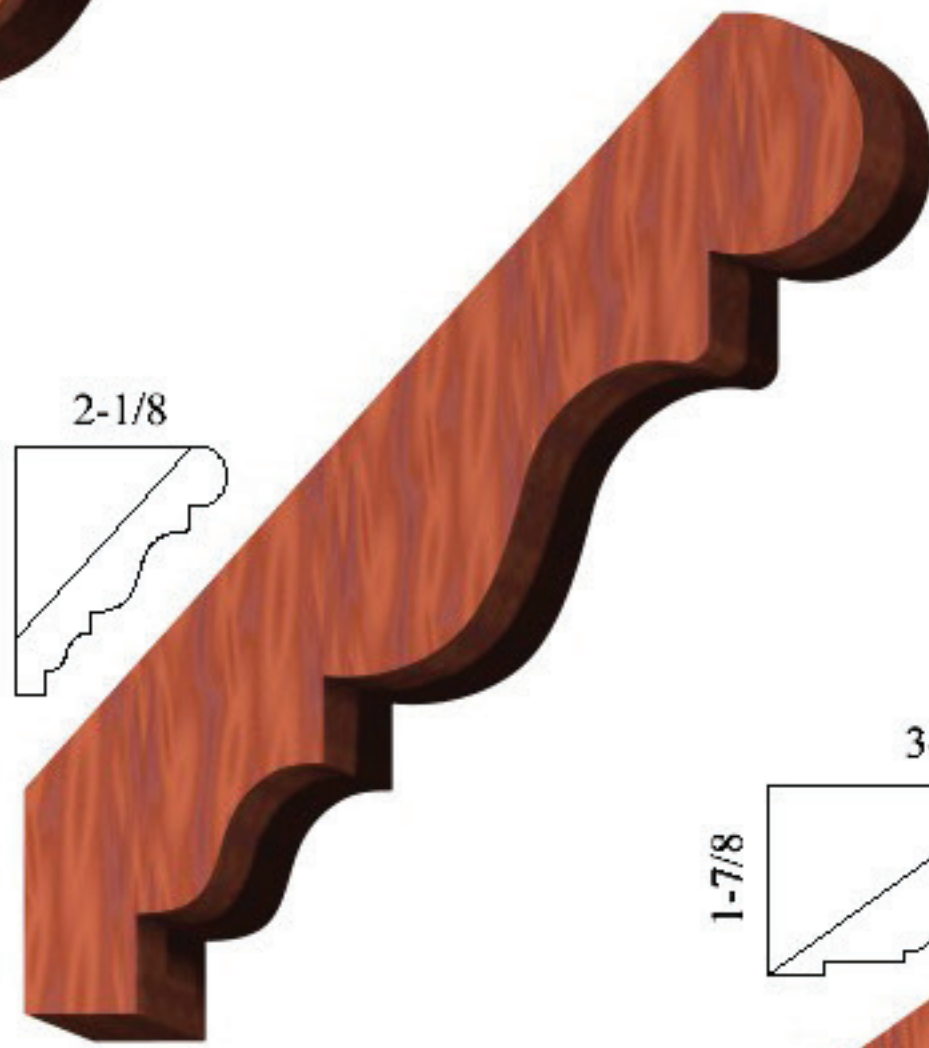

CR134
1/2 x 3-1/16

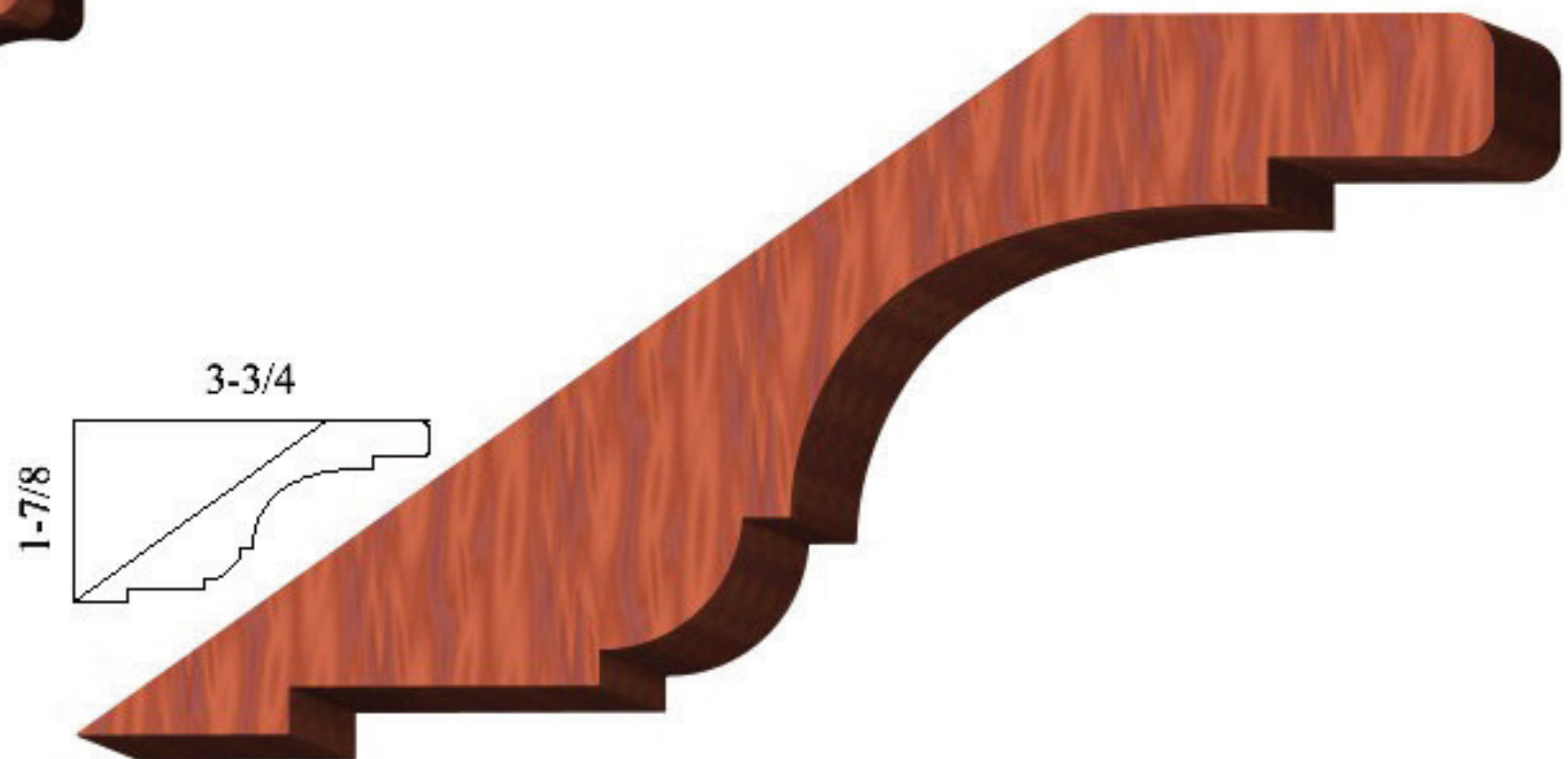

CR20
11/16 x 4-1/8

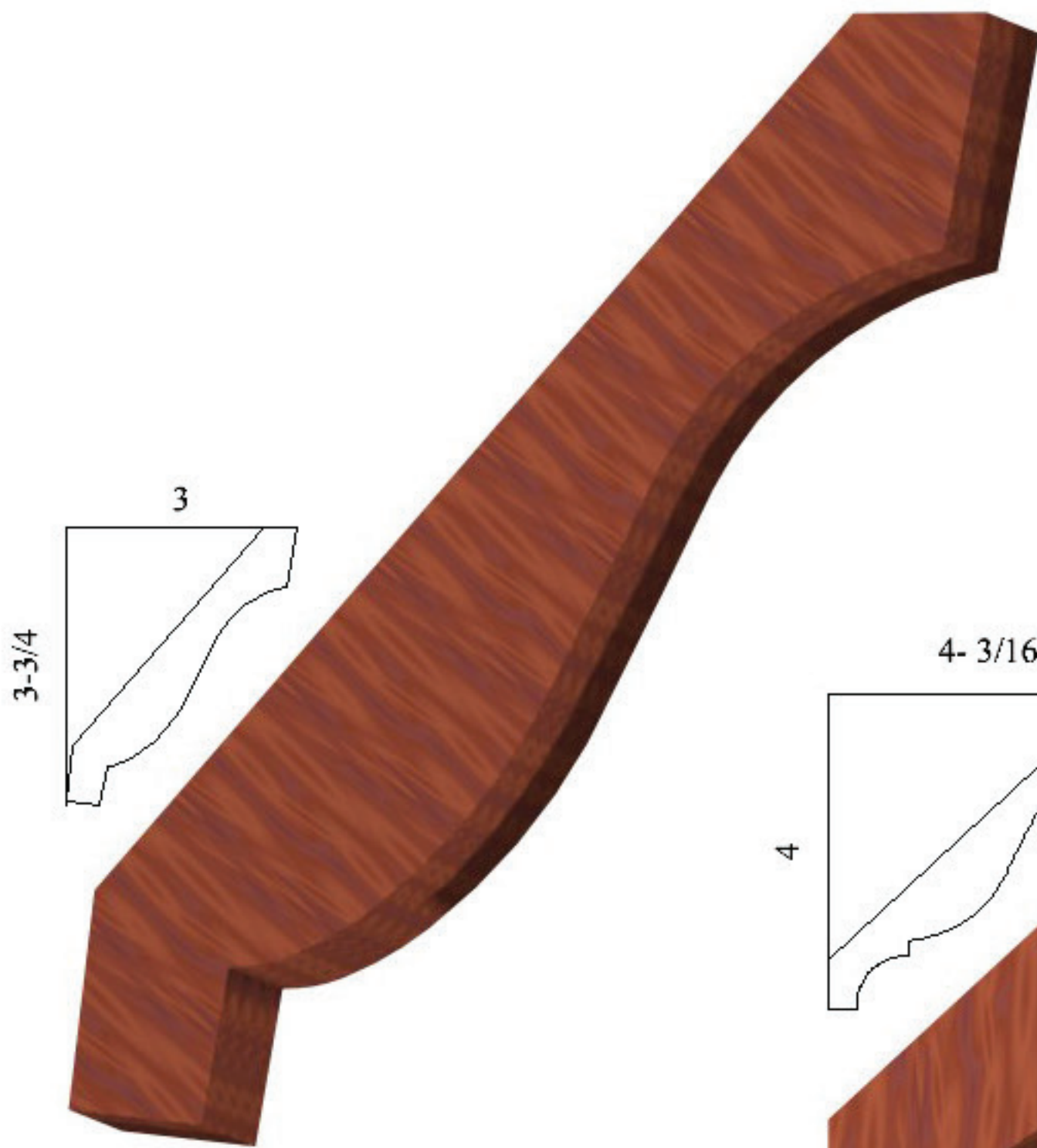

CR224
 $3/4 \times 4-5/8$

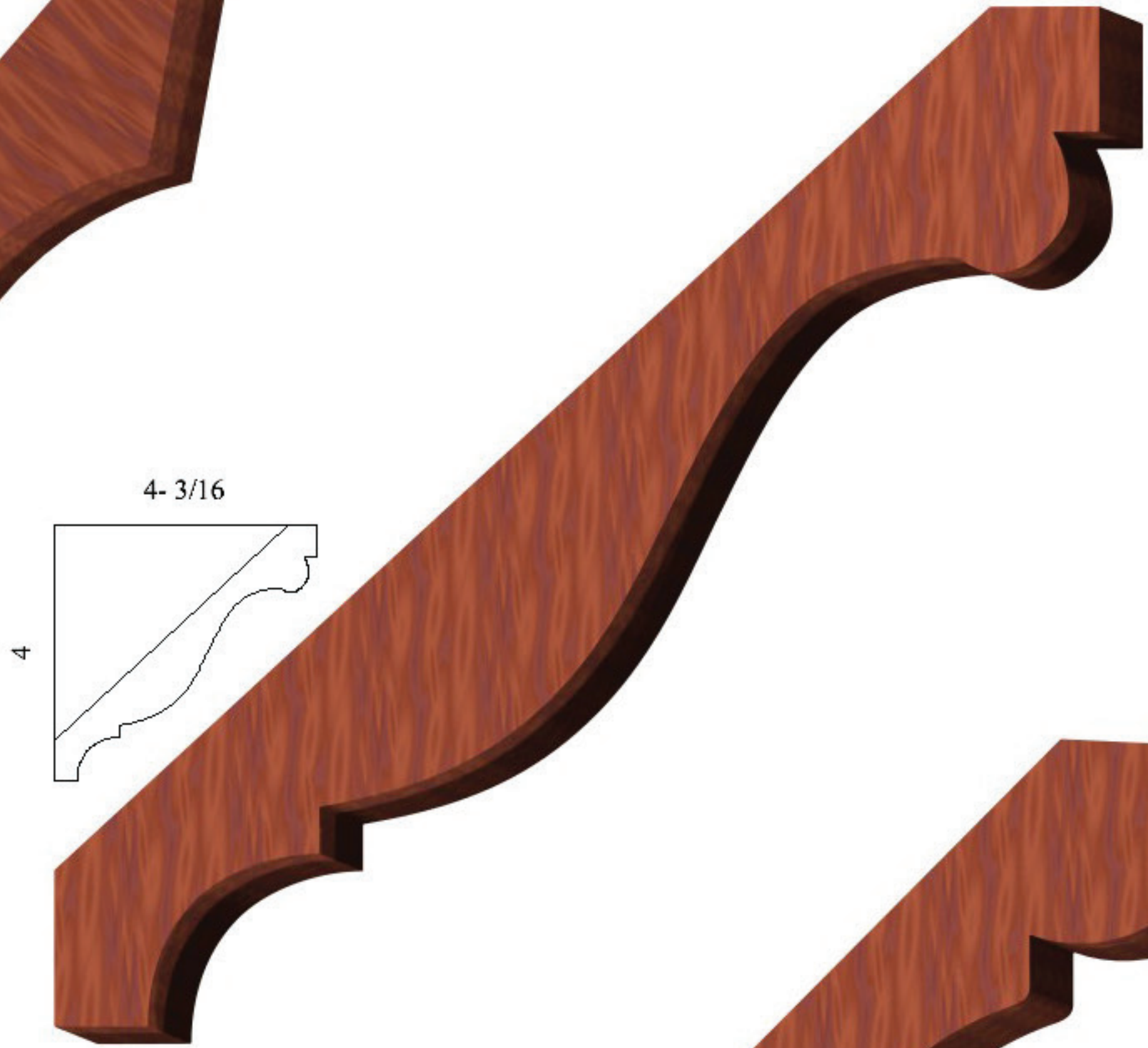

CR35
 $7/8 \times 6$

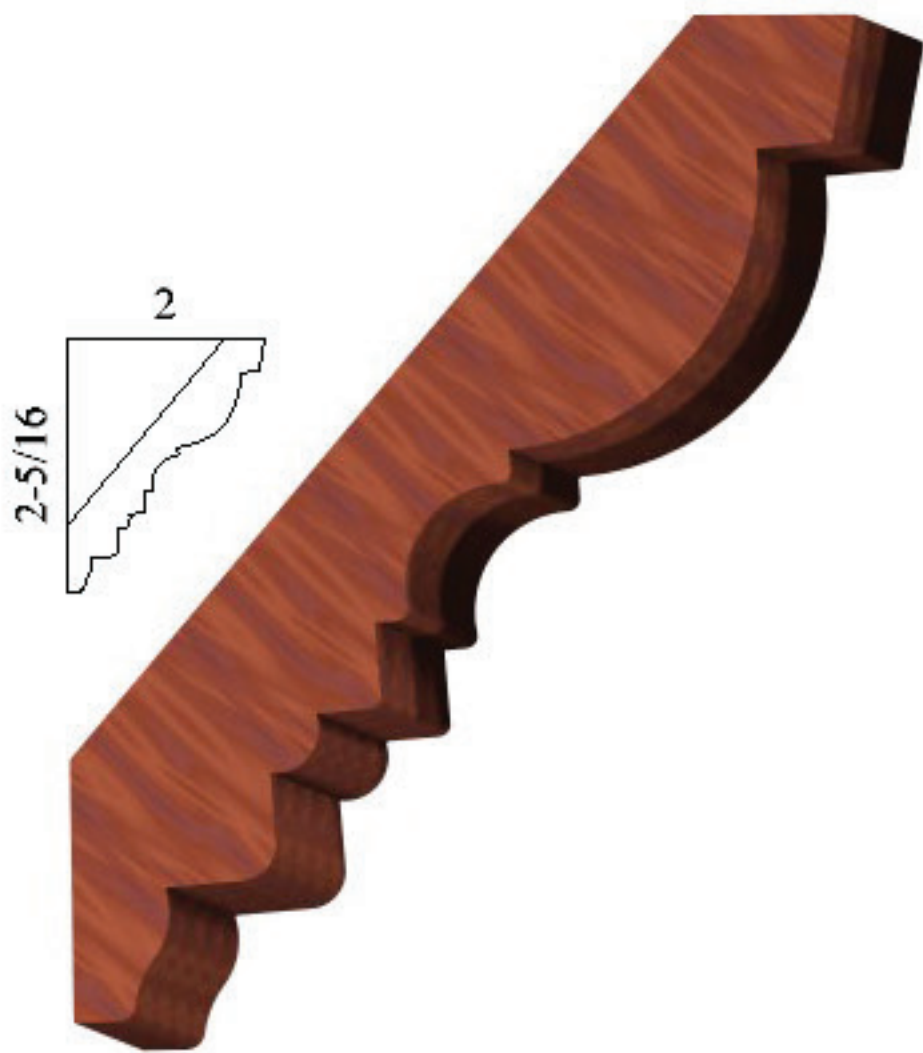

CR182
 $9/16 \times 3-3/16$



CR69
 $13/16 \times 6-1/8$

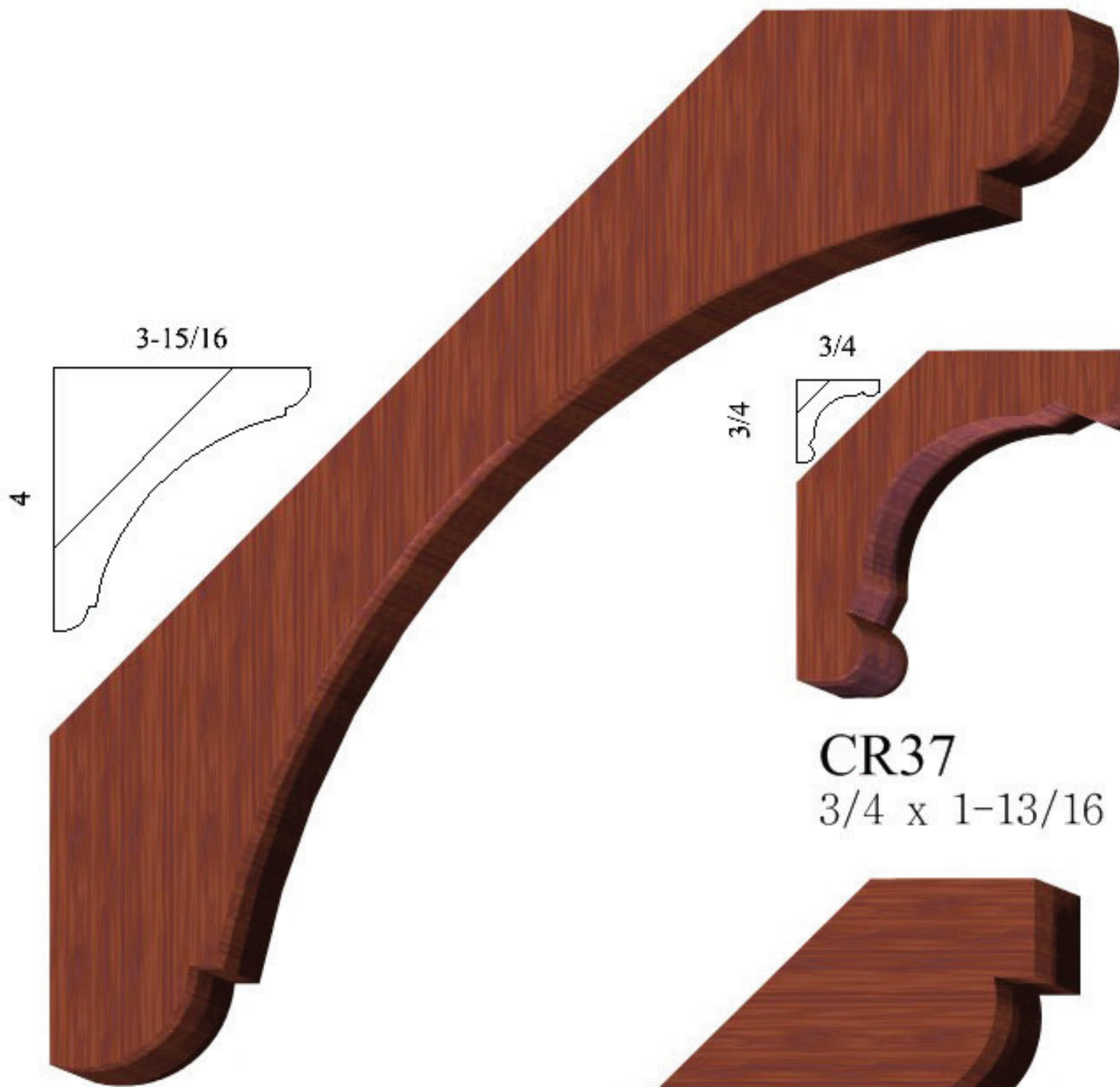

CR91
1-1/16 x 5-9/16



CR37
3/4 x 1-13/16

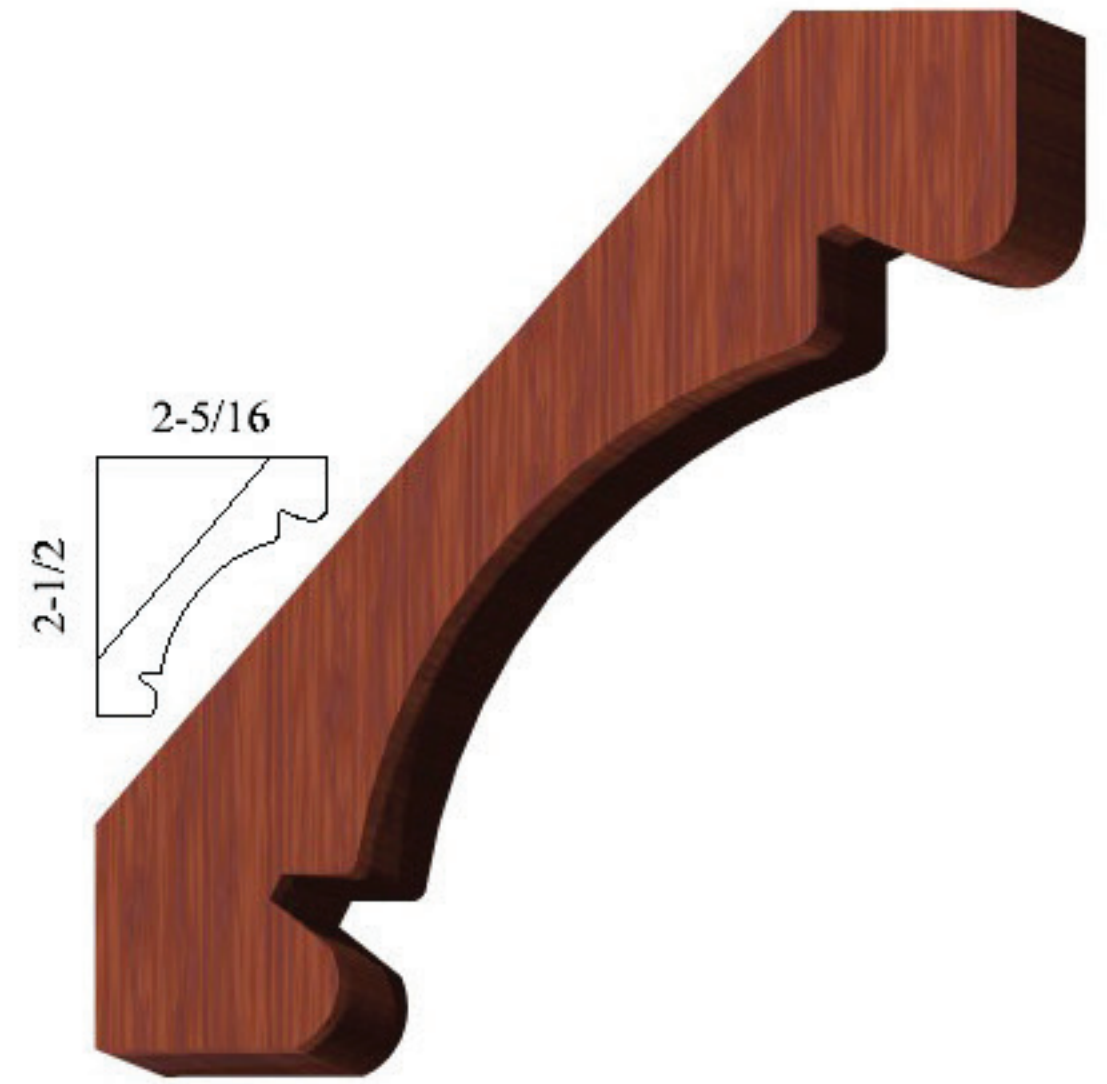

CR109
3/4 x 3-1/2

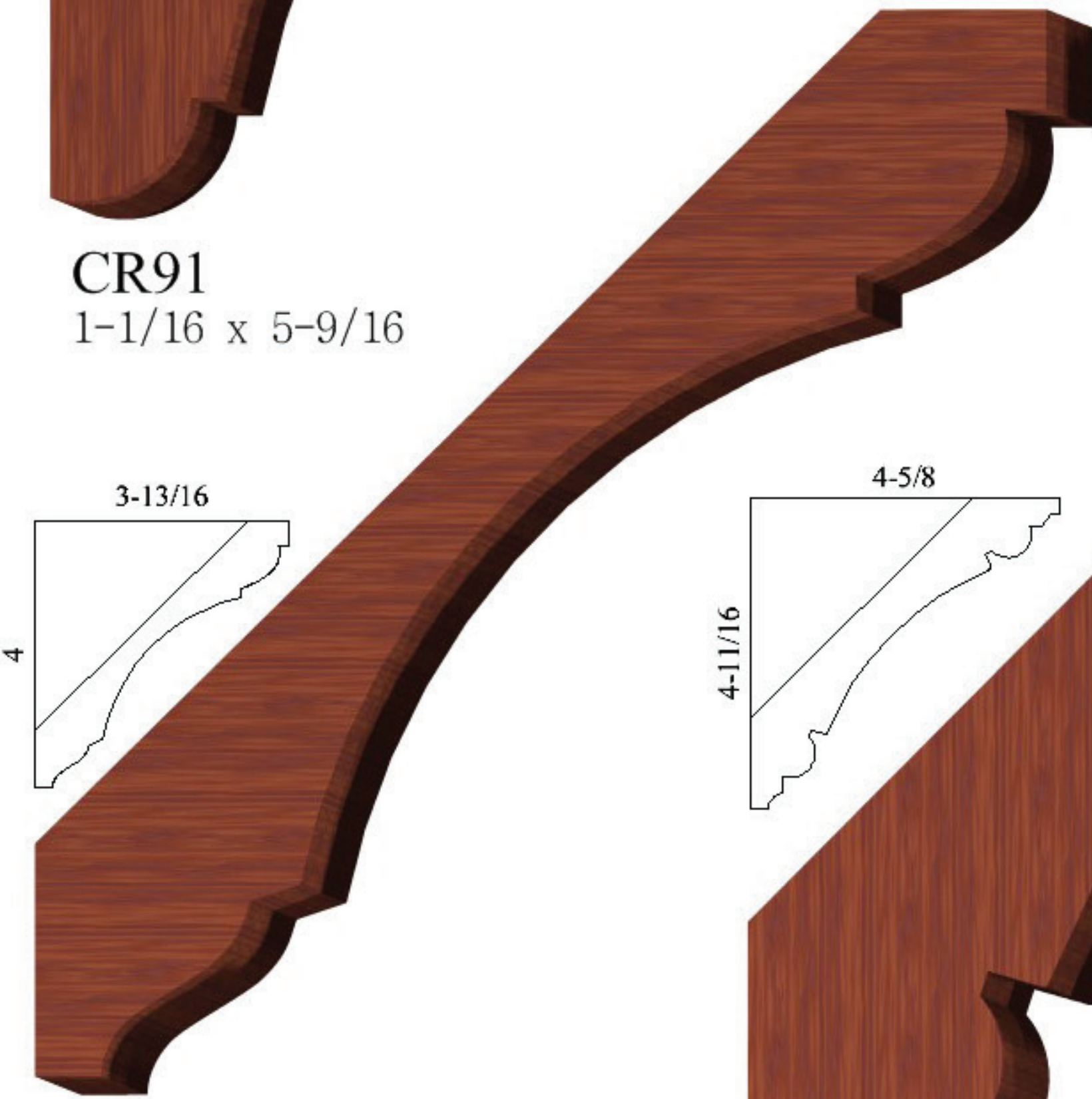

CR114
3/4 x 5-9/16



CR90
1-11/16 x 7

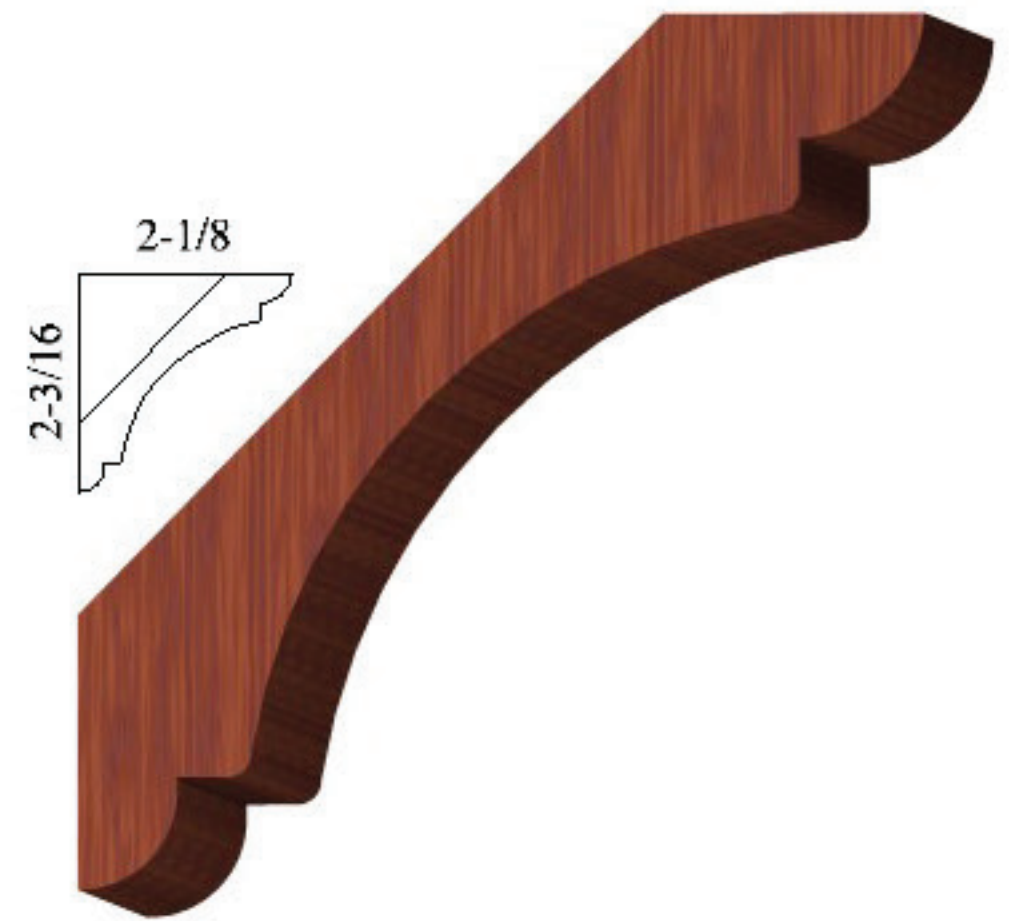

CR76
1/2 x 3-1/16



CR204
1/2 x 1-1/4

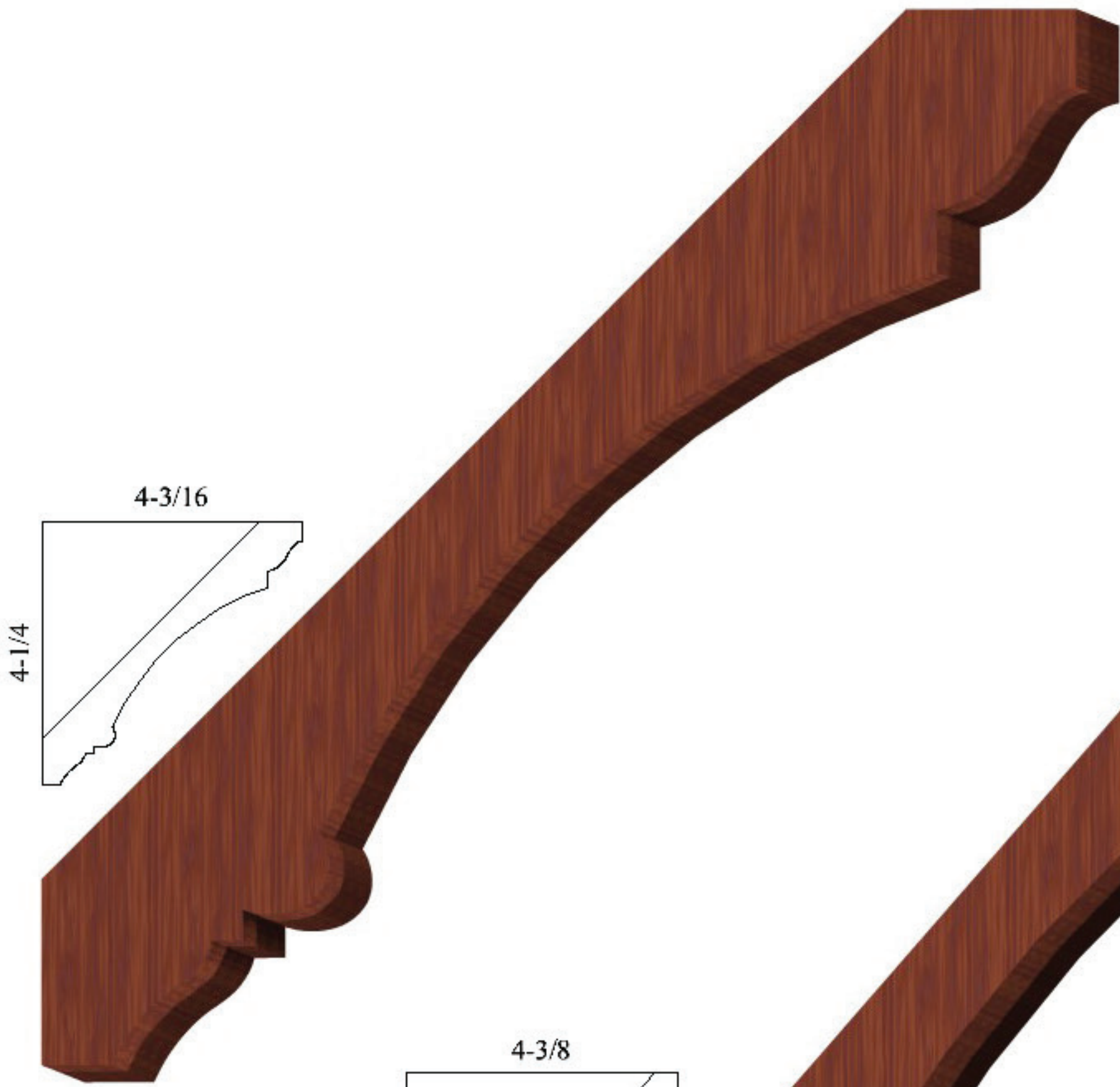

CR87
 $13/16 \times 6$

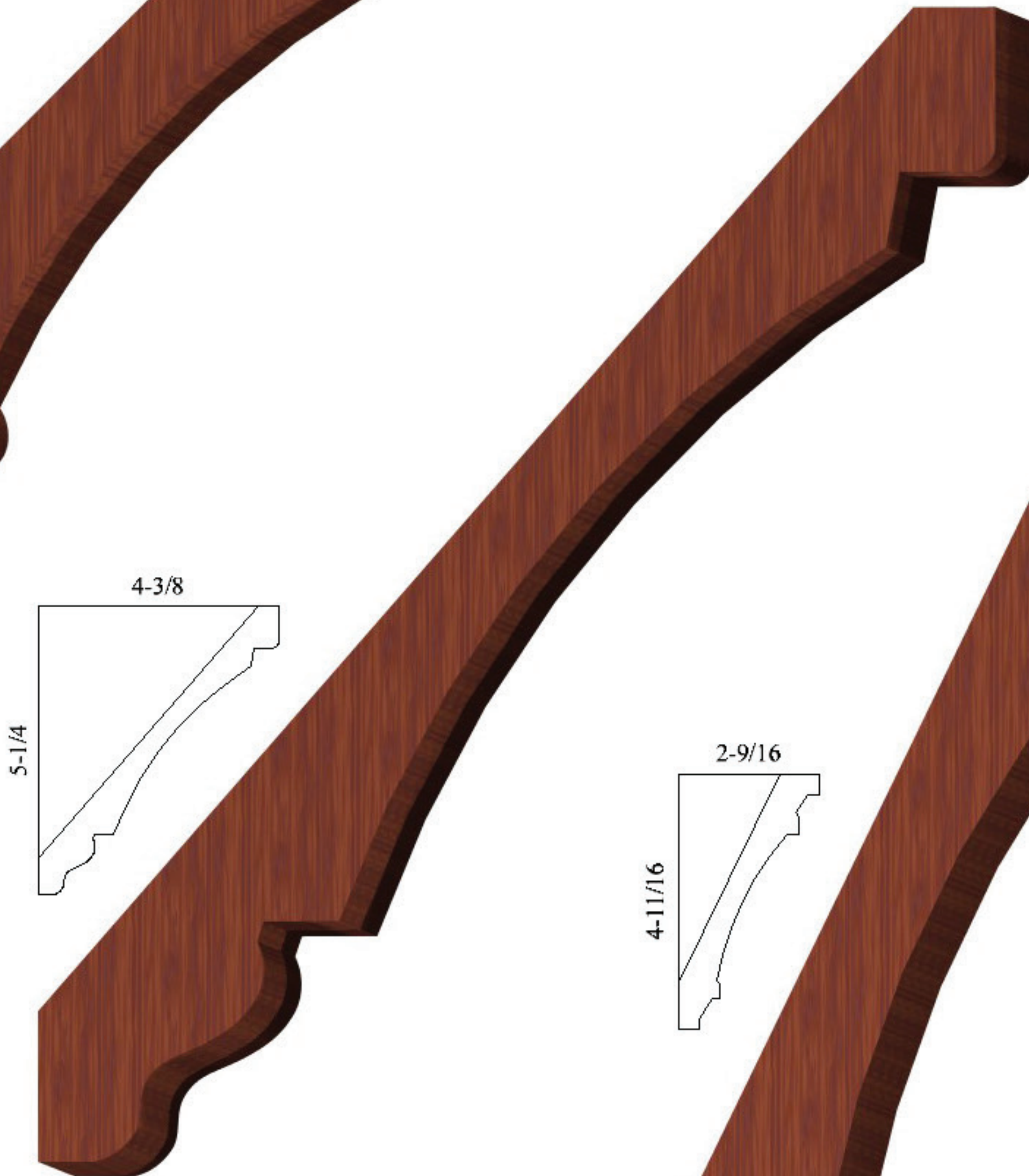

CR171
 $3/4 \times 6-7/8$

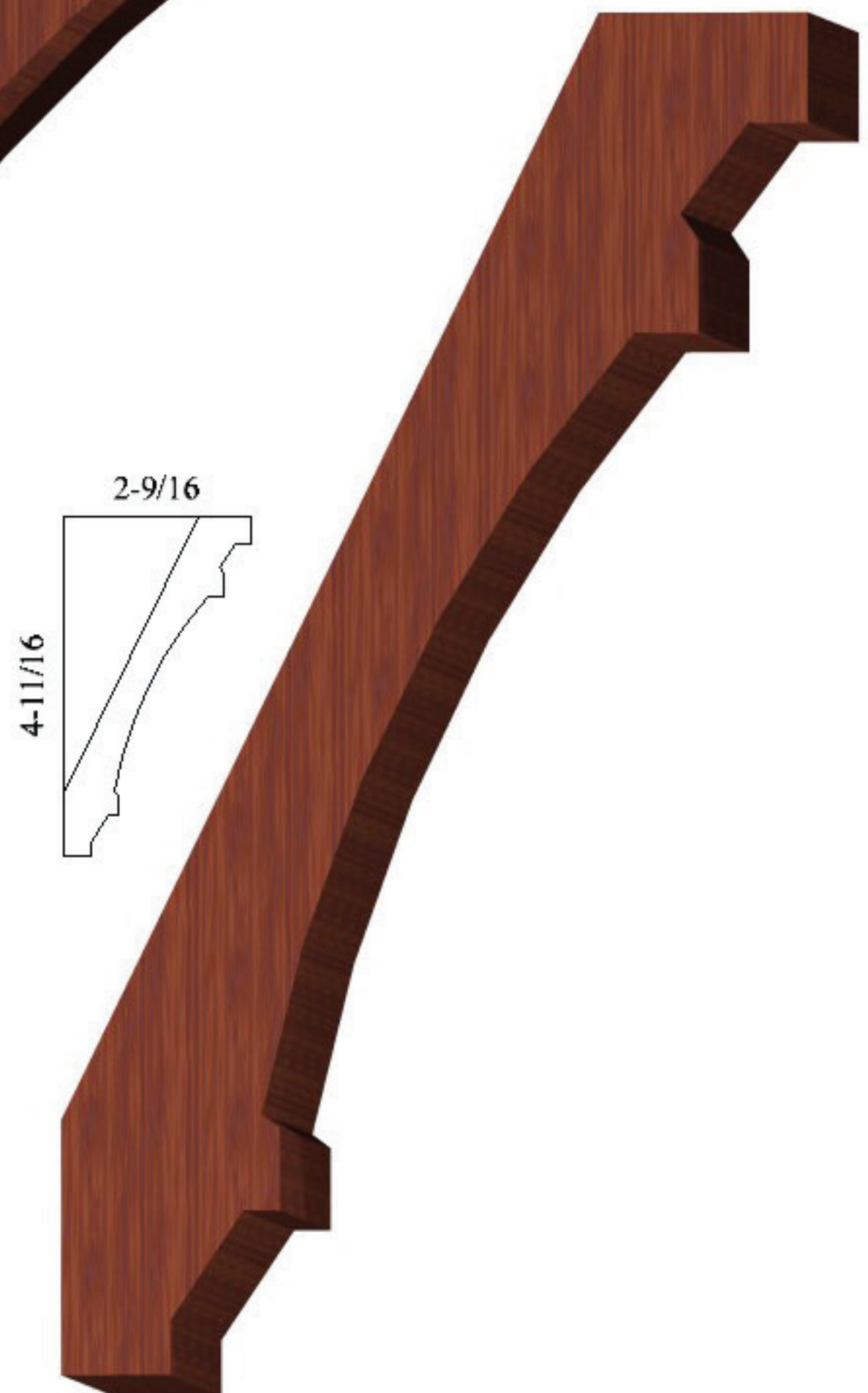

CR160
 $3/4 \times 5-5/16$

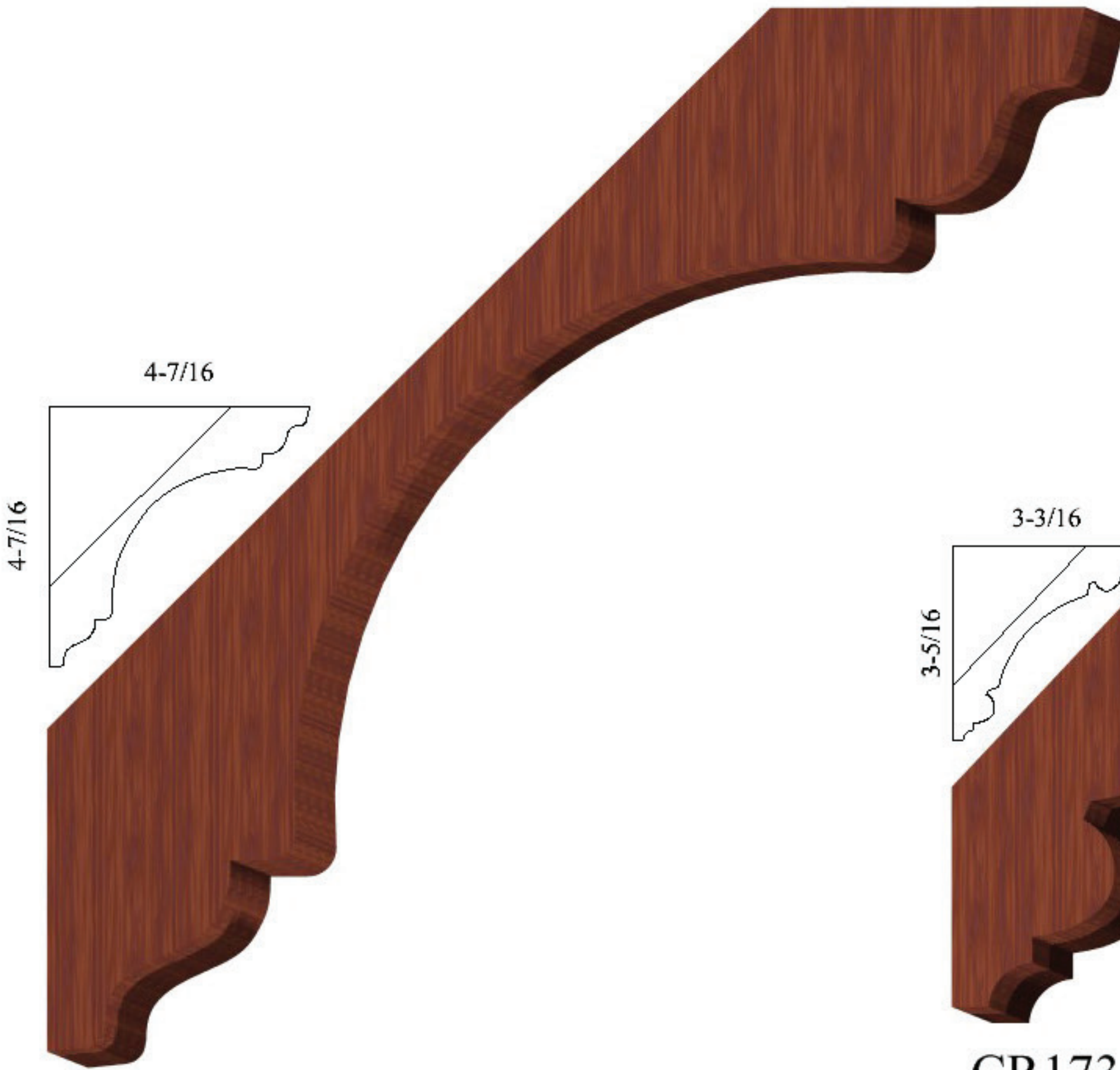

CR130
1-1/4 x 6-5/8

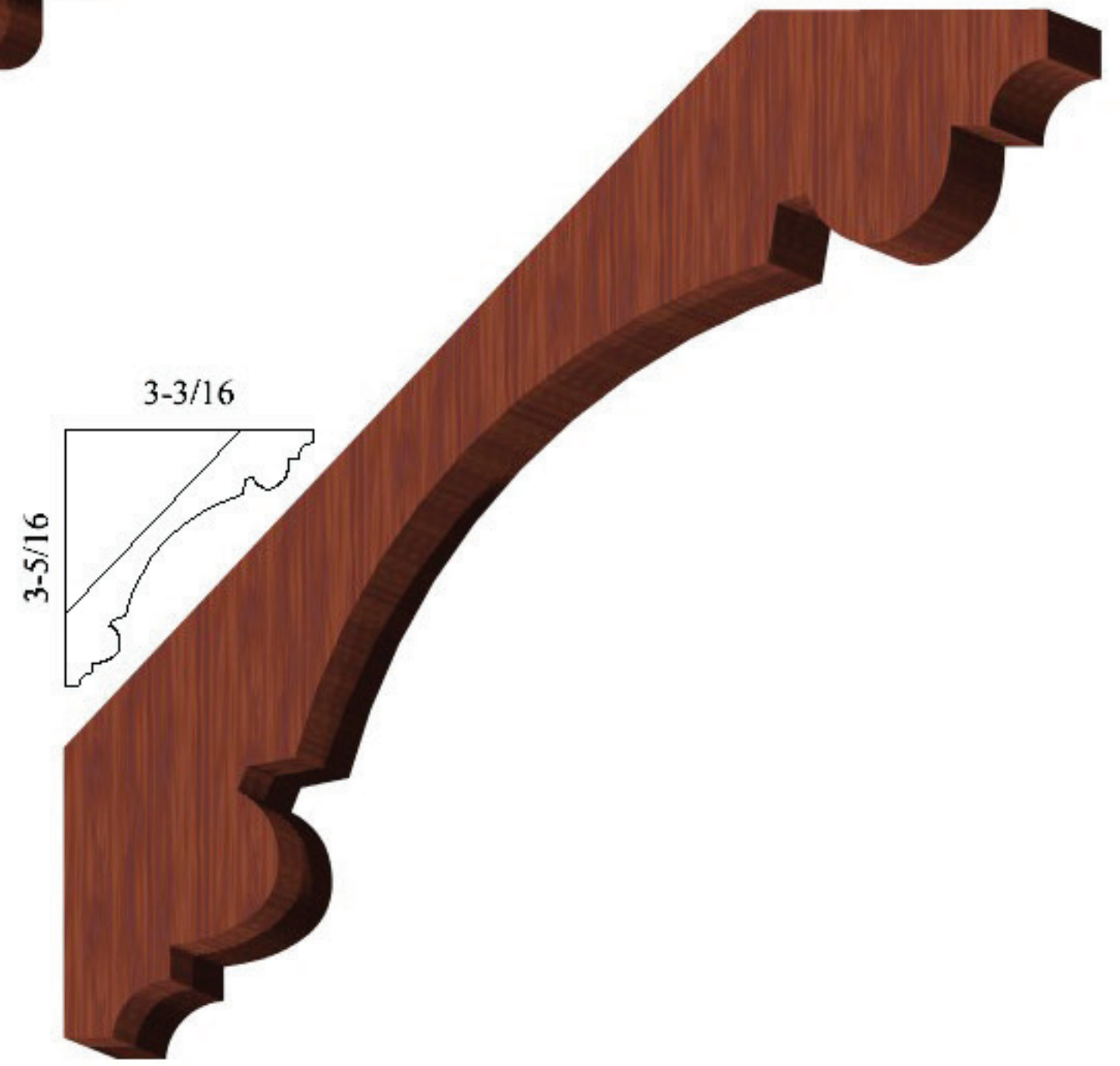

CR173
1-1/2 x 4-5/8

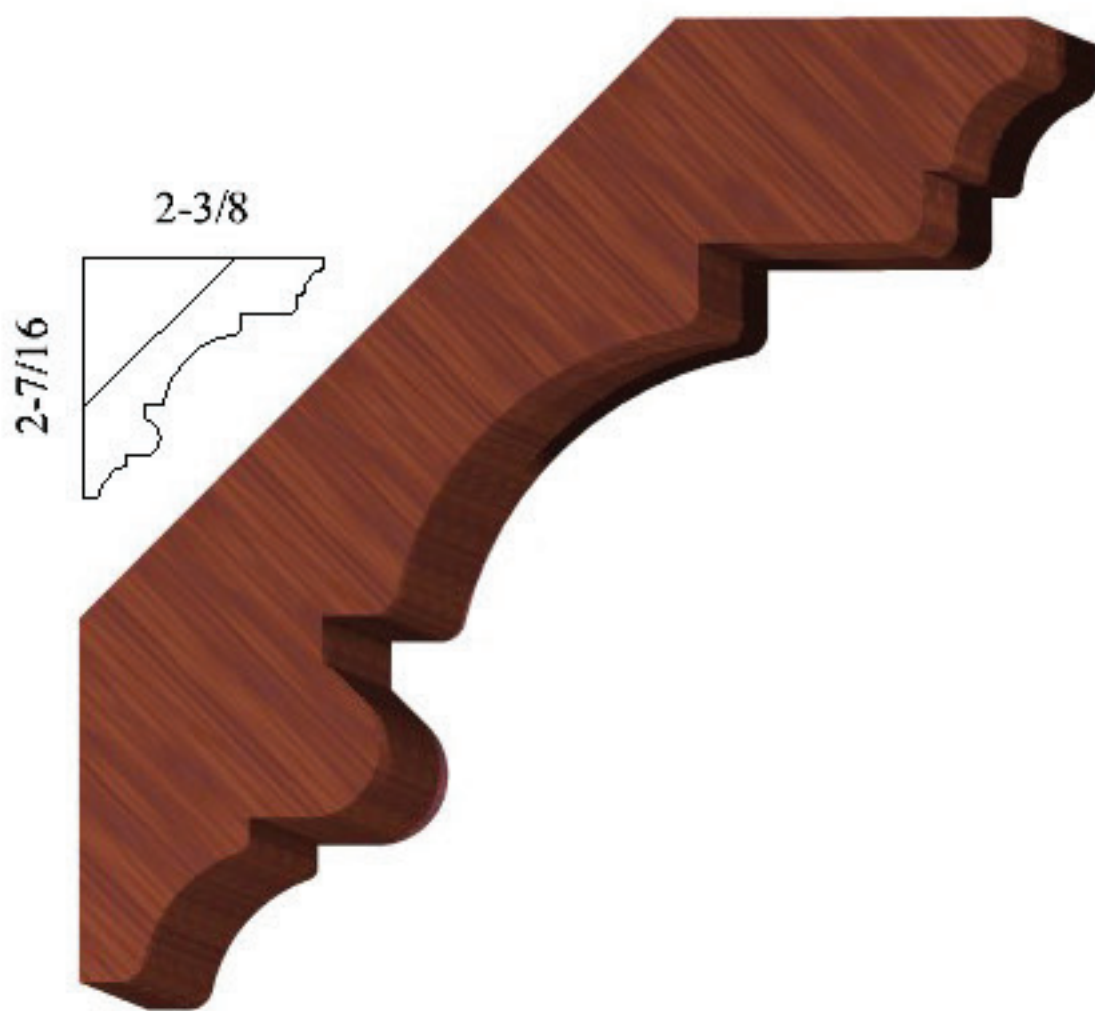

CR214
7/8 x 3-3/8

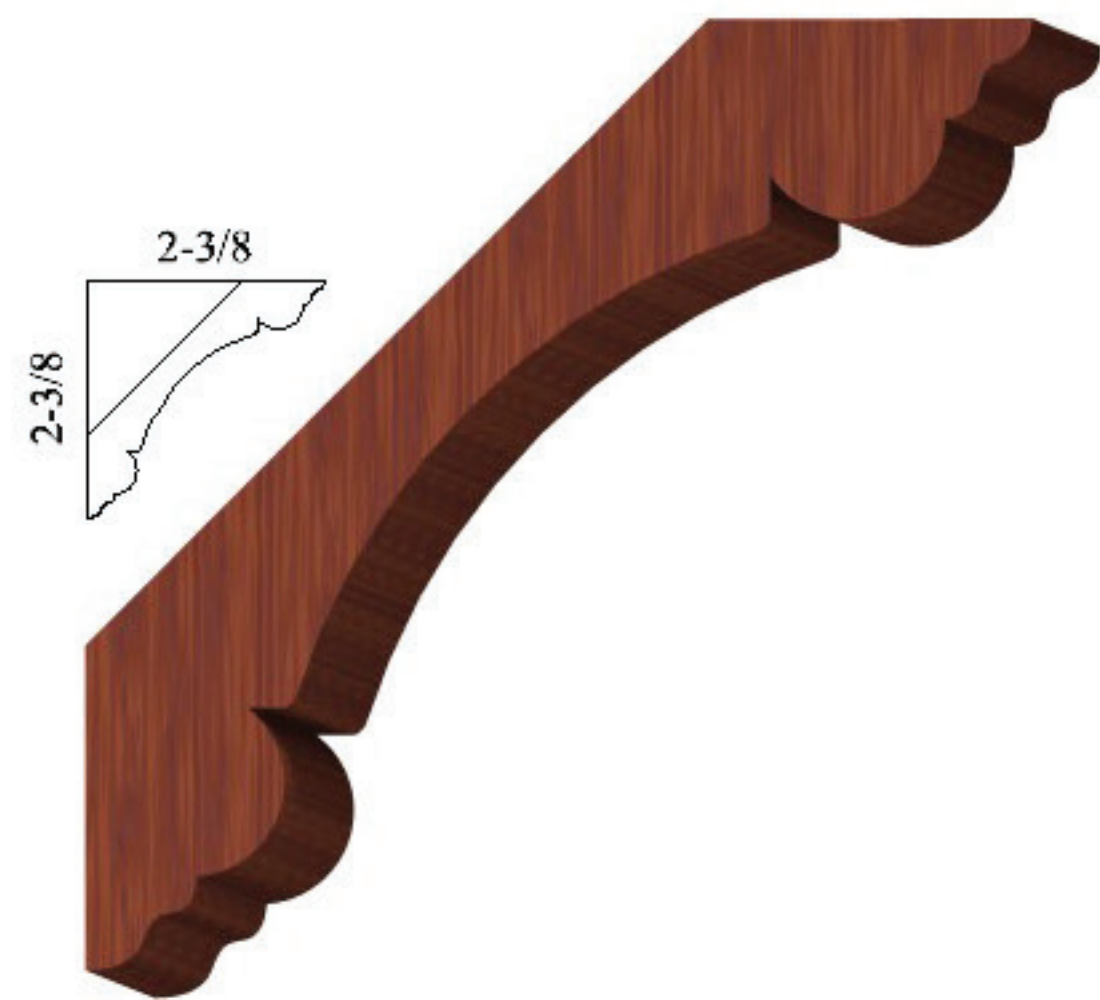

CR161
11/16 x 3-3/8

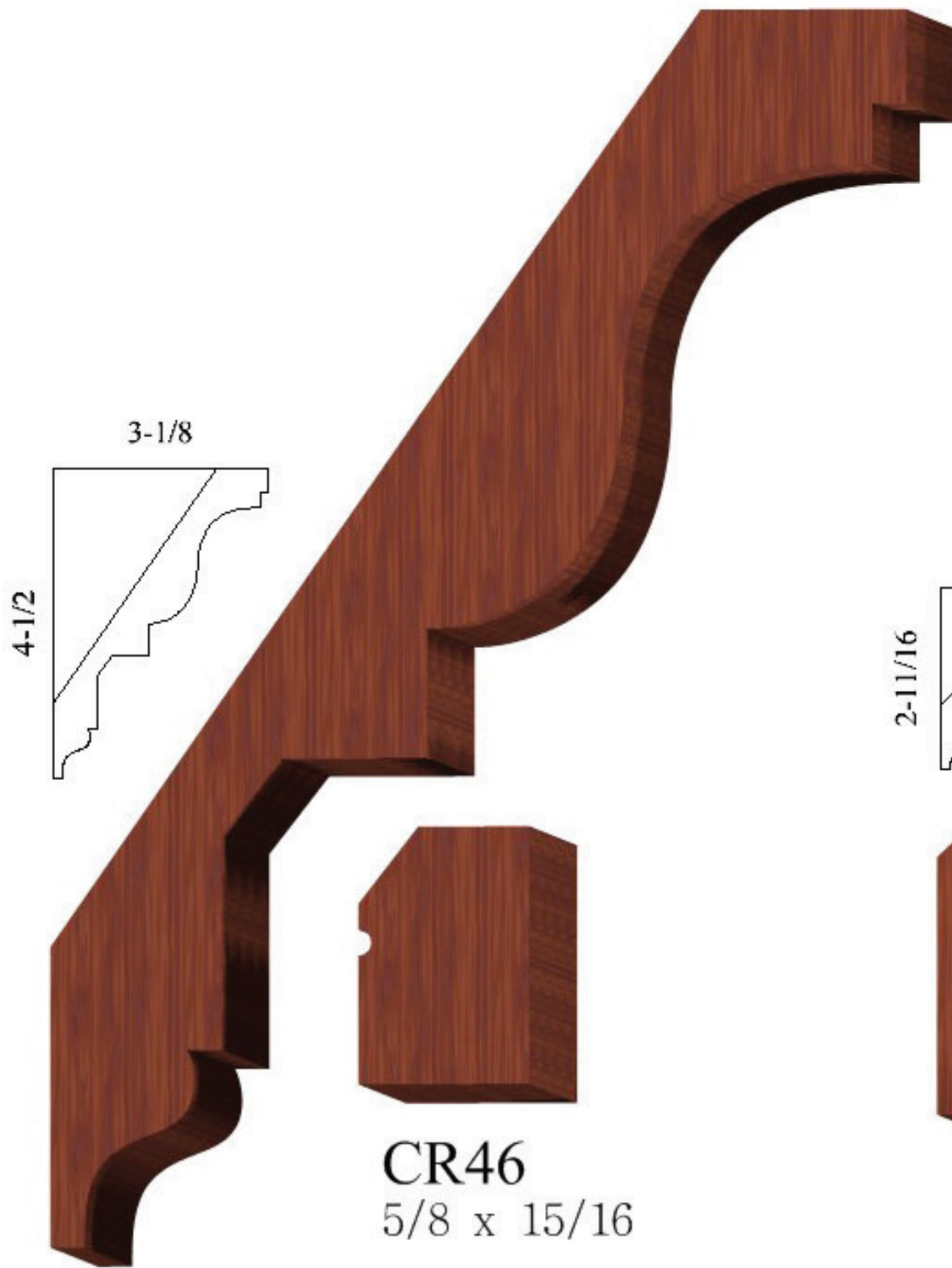

CR03
7/8 x 5-1/2

CR46
5/8 x 15/16



CR40
3/4 x 3-13/16

CR62
3/4 x 5/8



CR86
3/4 x 3-3/4

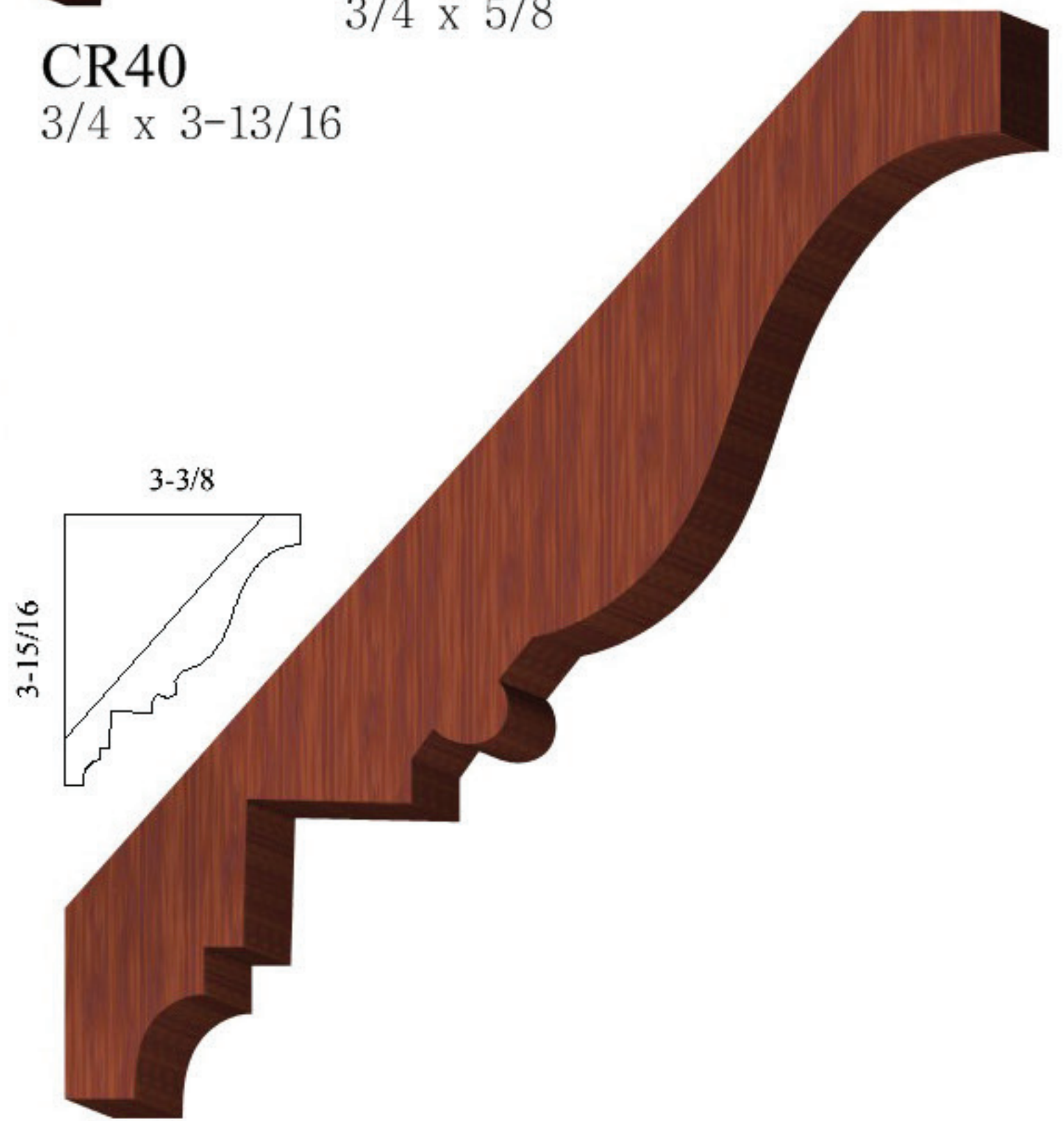

CR92
11/16 x 5-3/16

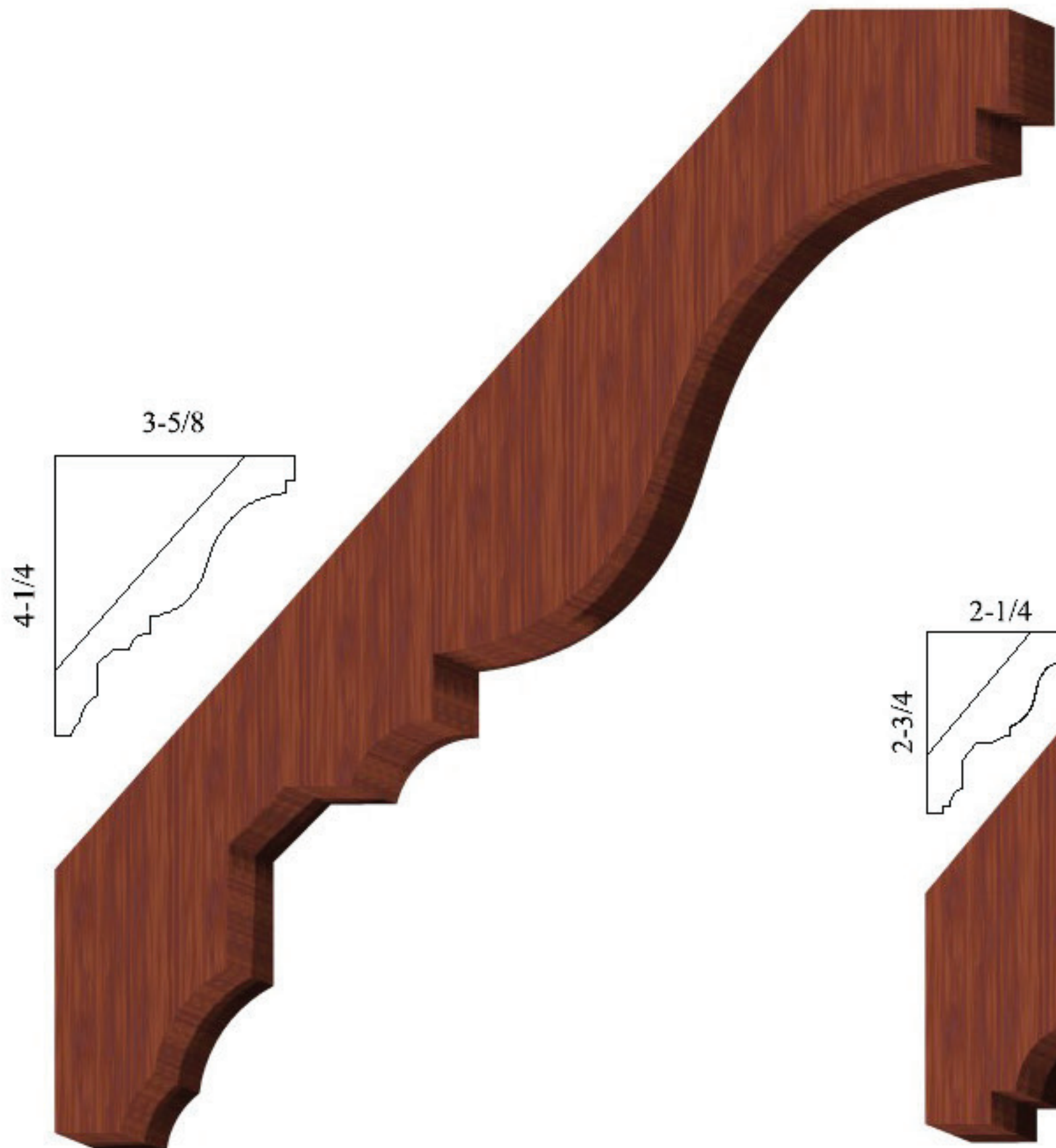

CR73
 $13/16 \times 6$

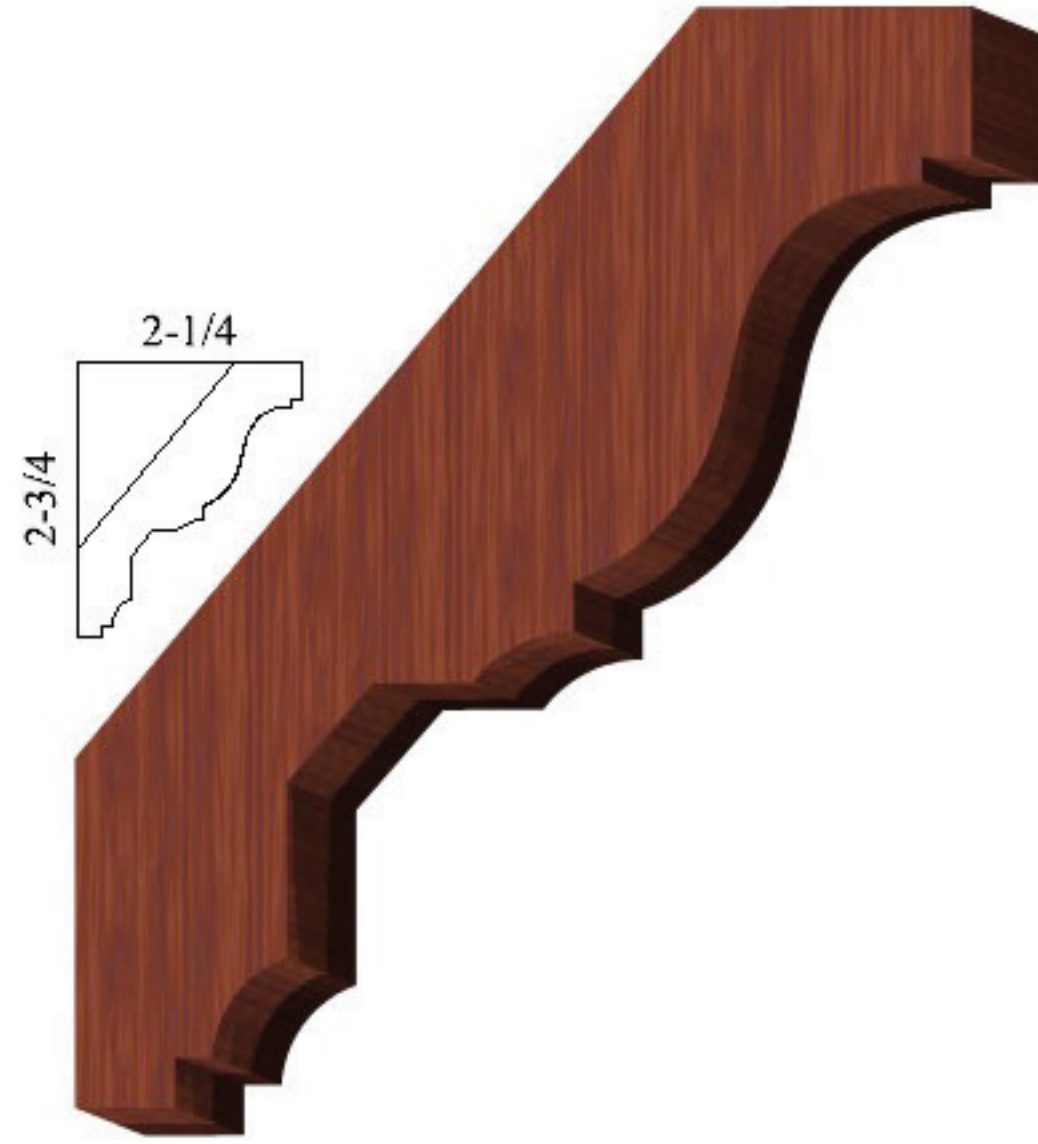

CR88
 $3/4 \times 3-9/16$



CR121
 $3/4 \times 2-1/2$

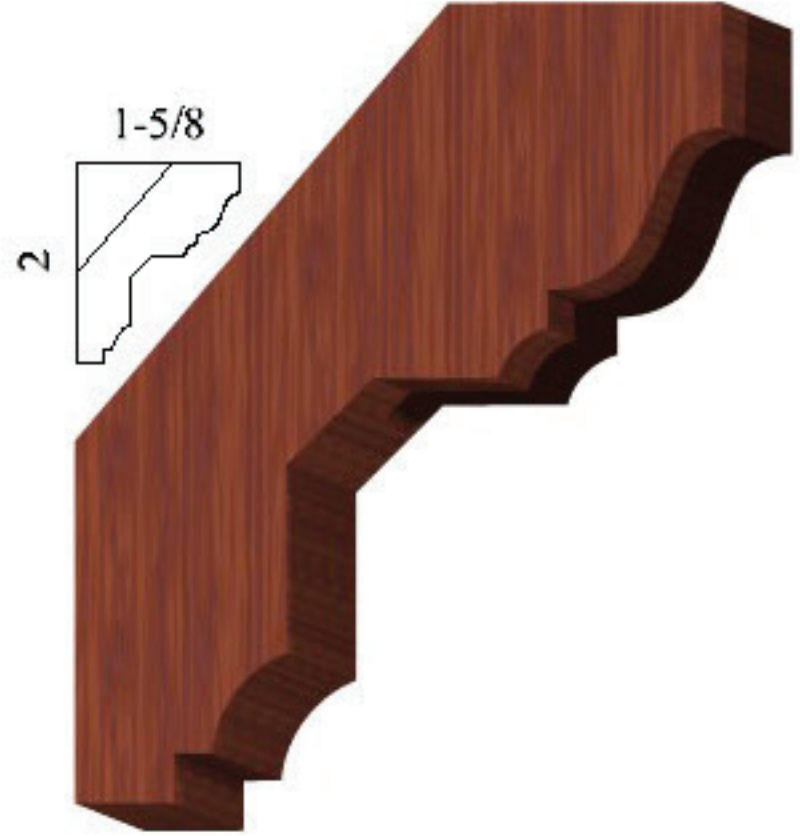

CR124
 $3/4 \times 2-1/2$

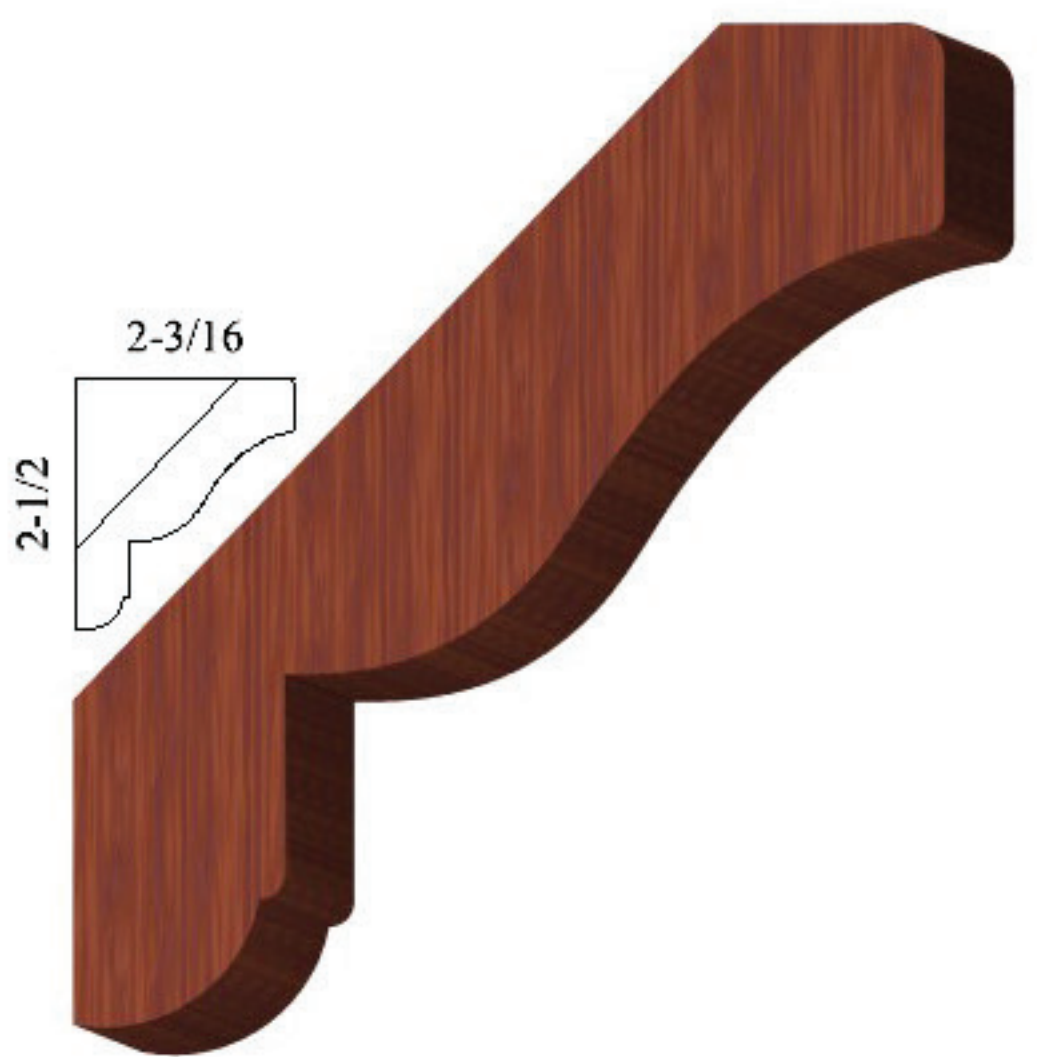

CR129
 $3/4 \times 3-1/4$

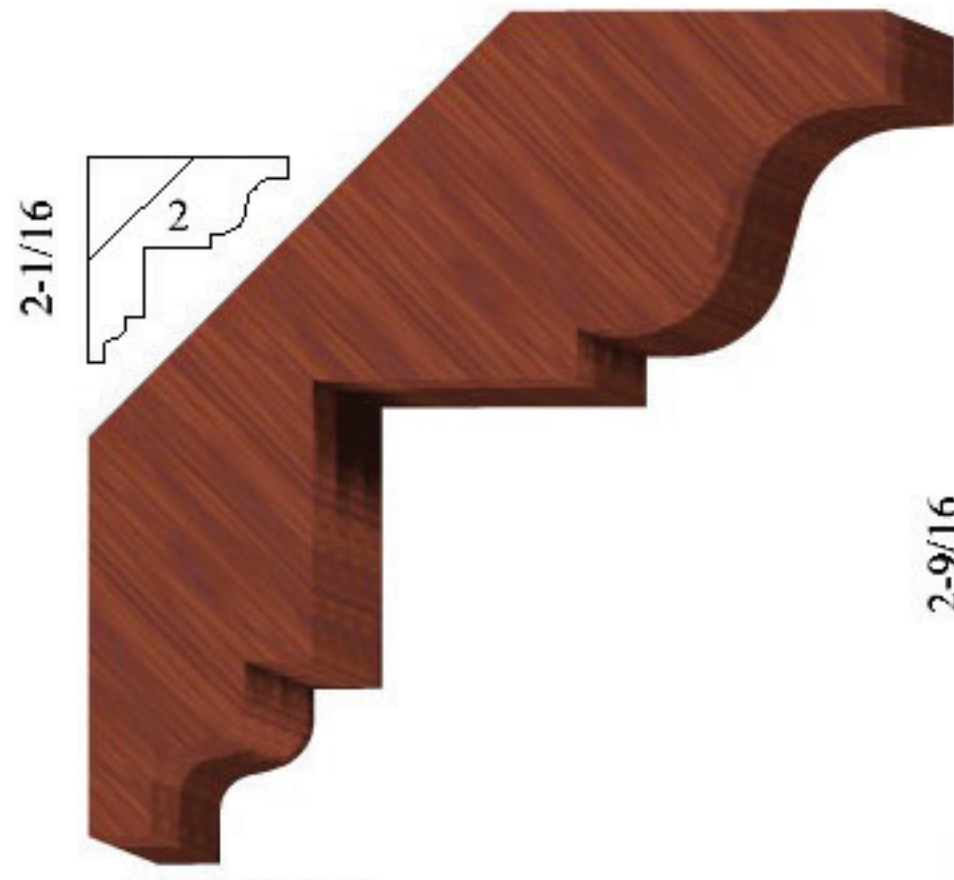

CR223
13/16 x 2-7/8

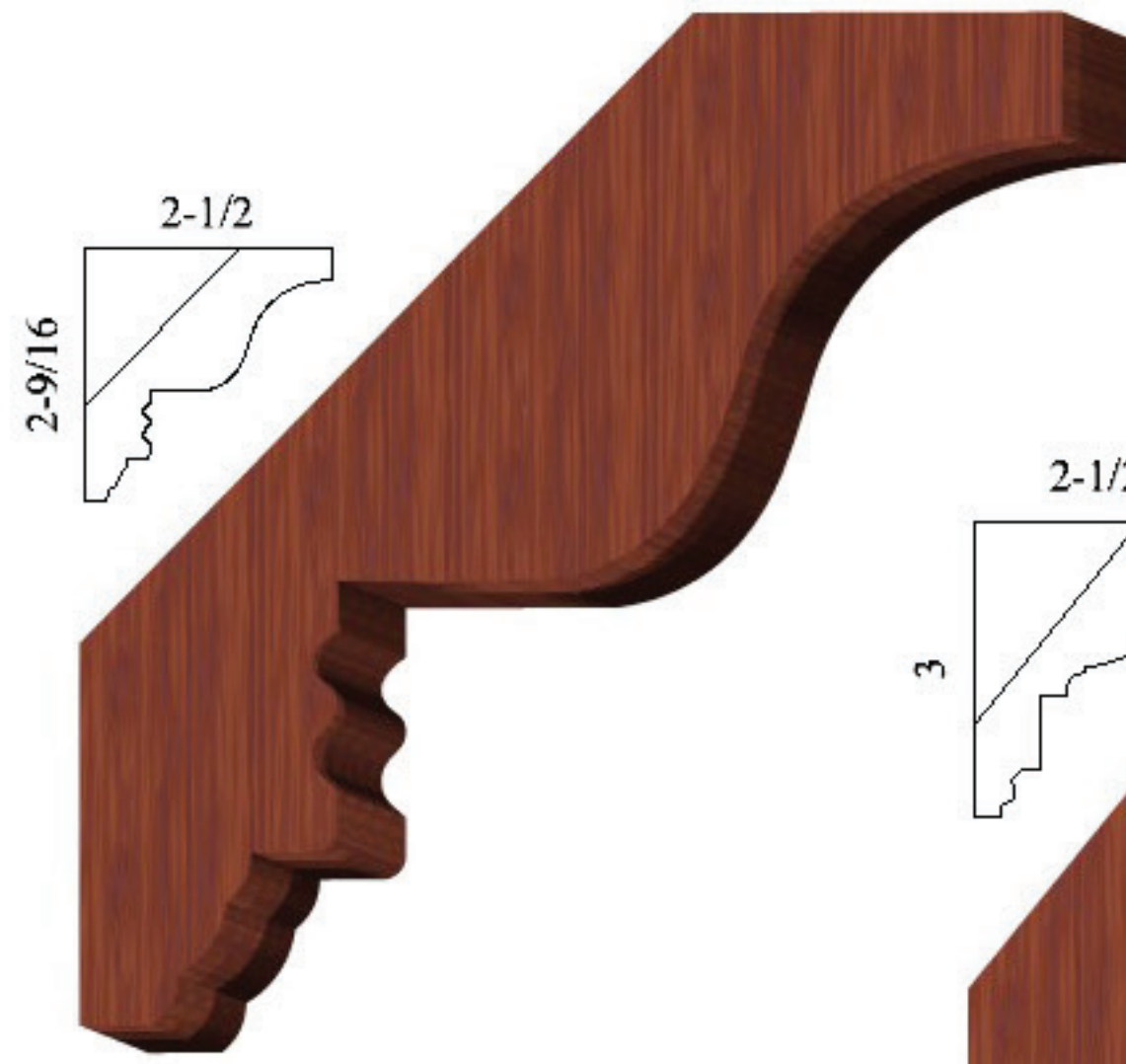

CR190
13/16 x 3-1/2

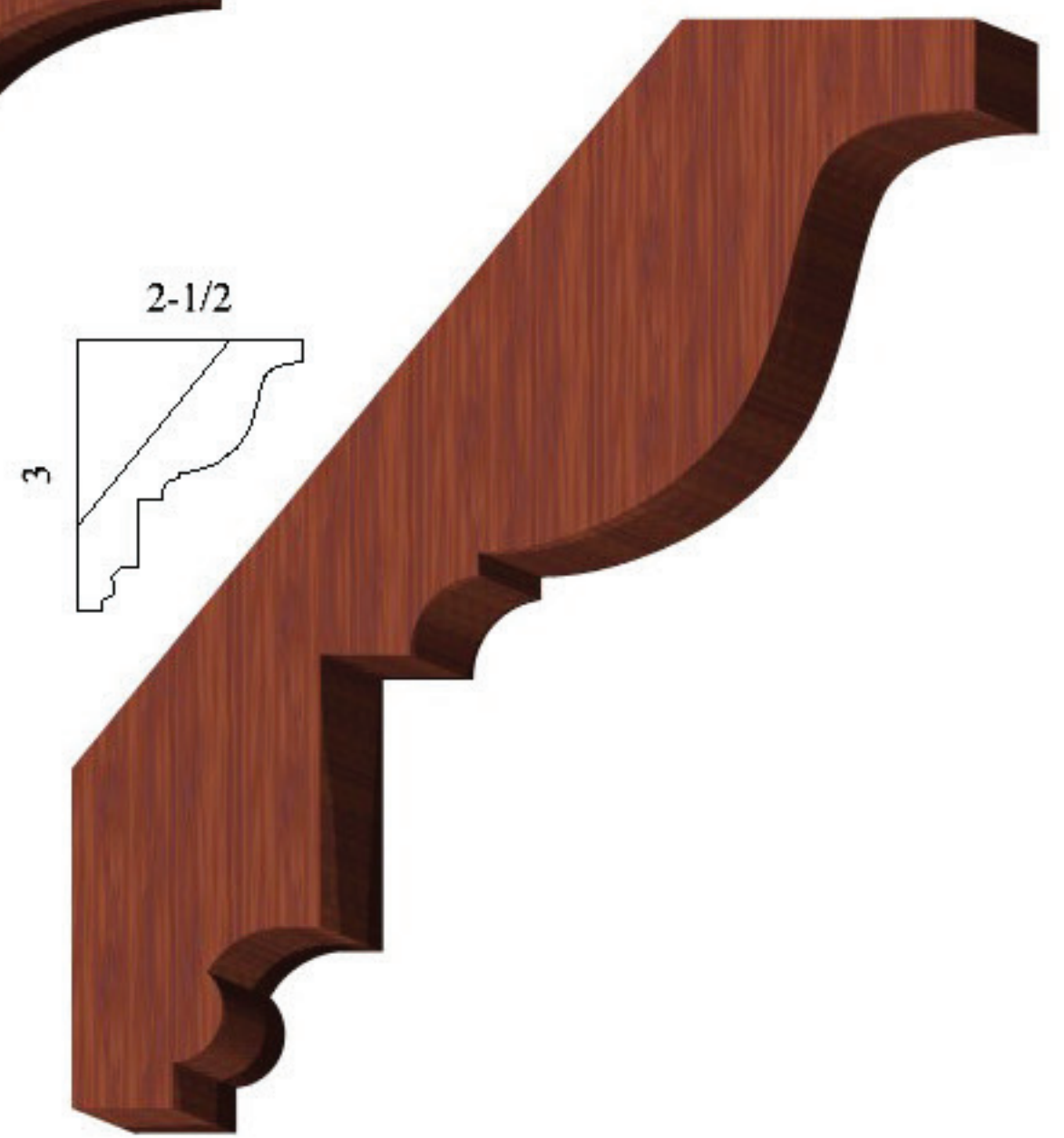

CR199
3 x 4

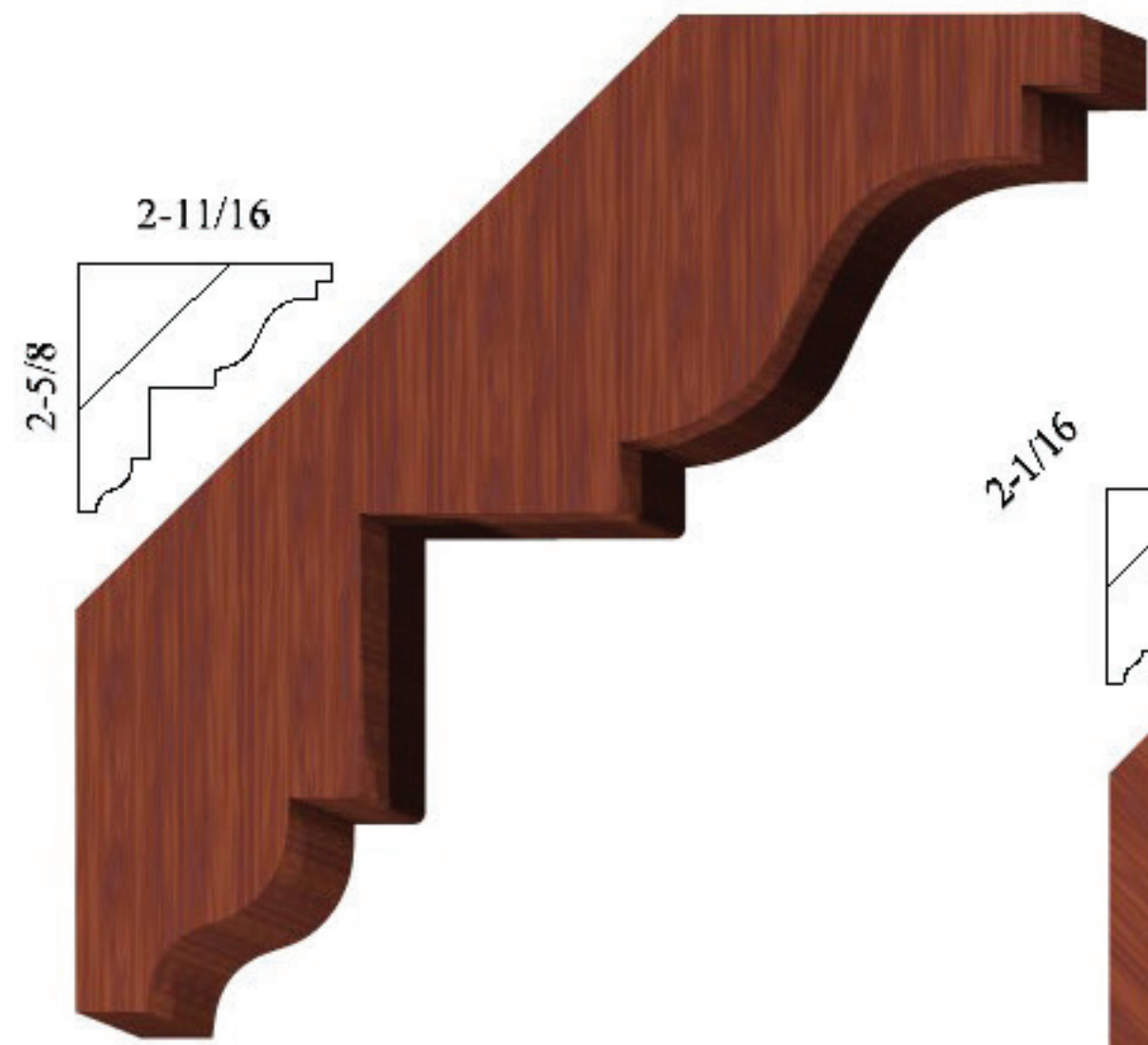

CR189
7/8 x 3-3/4

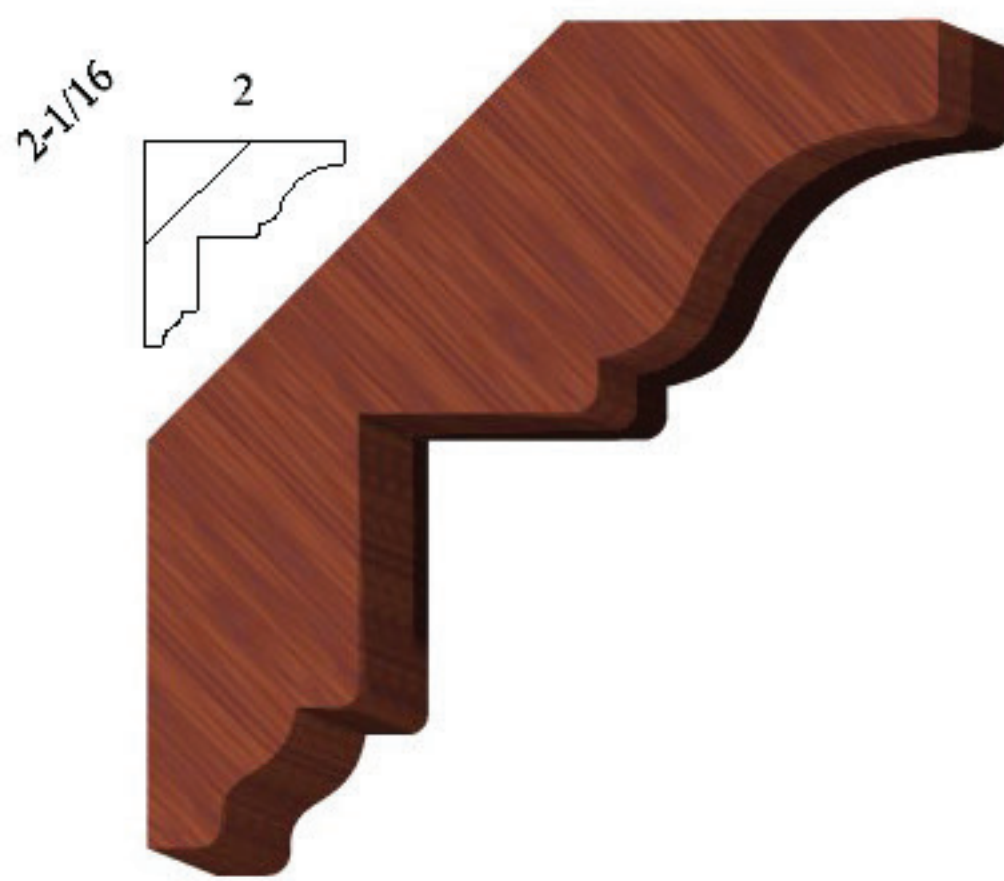

CR220
13/16 x 2-5/8

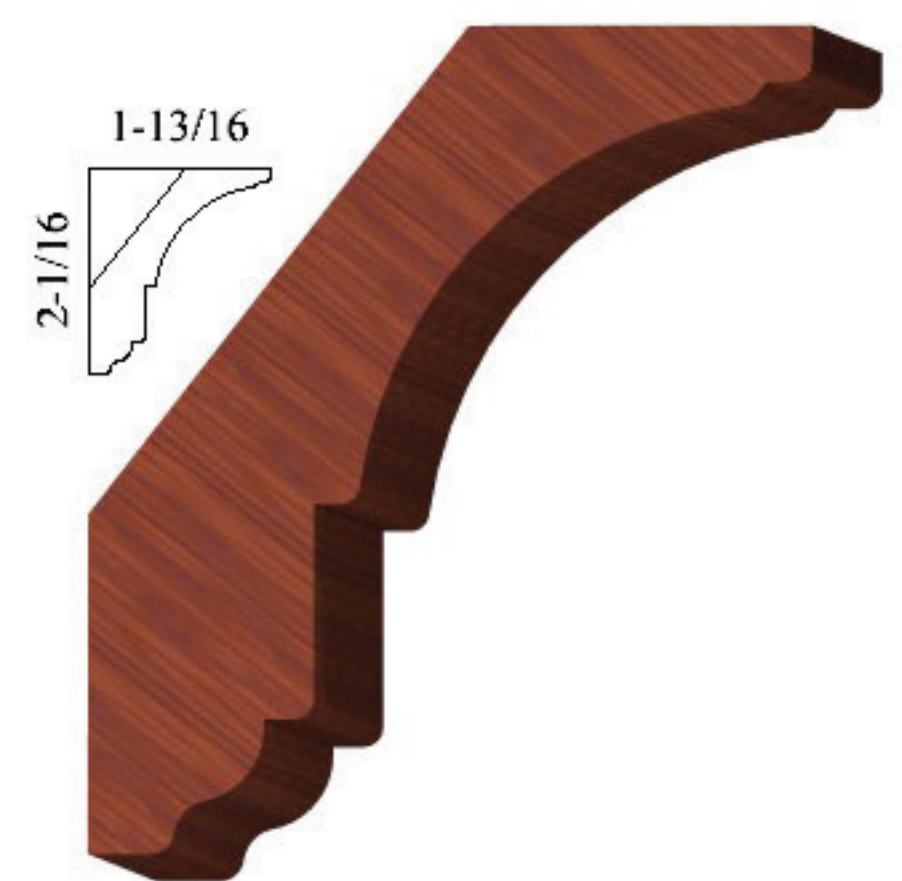

CR215
3/4 x 2-3/4

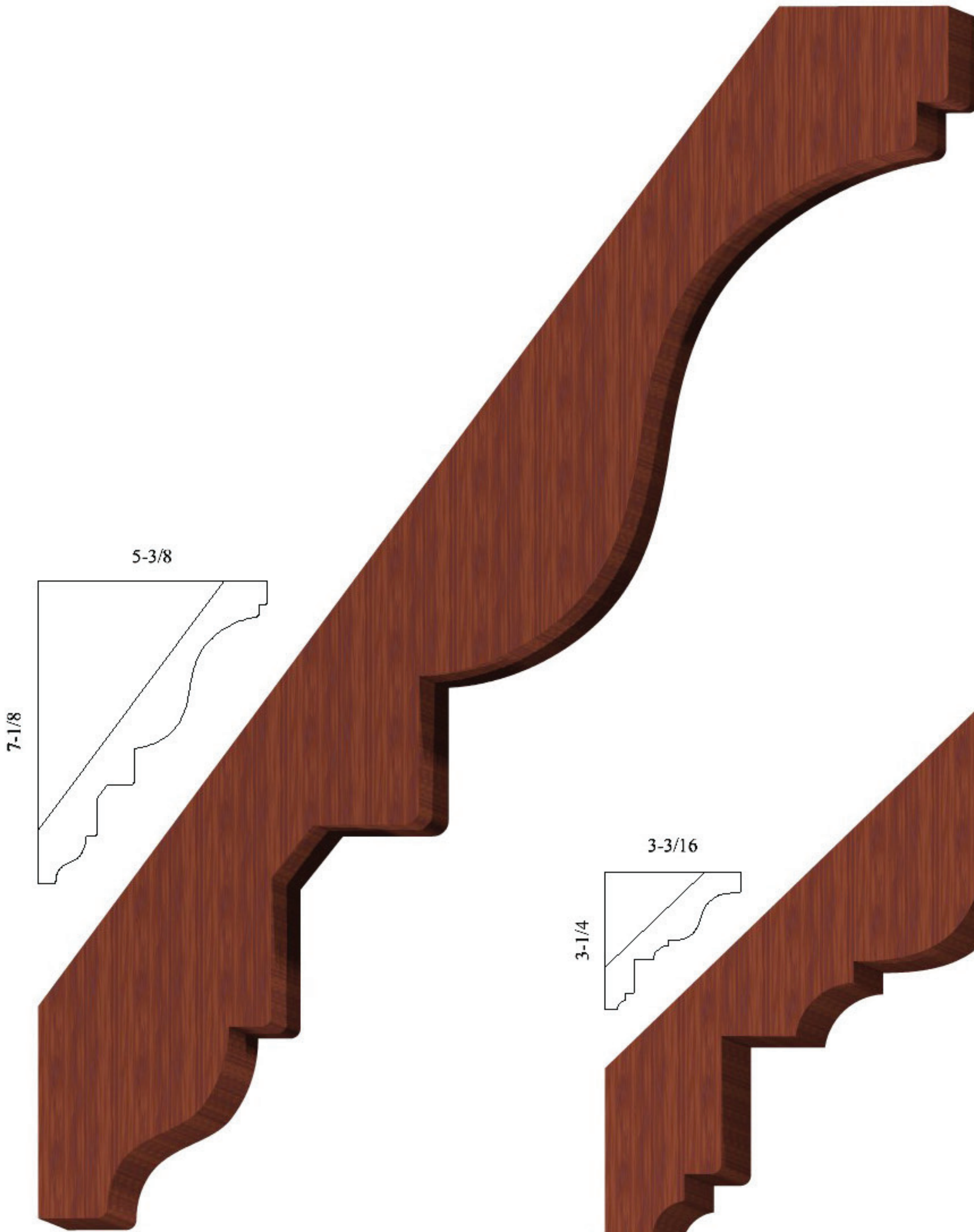

CR176
1-1/8 x 8-1/8

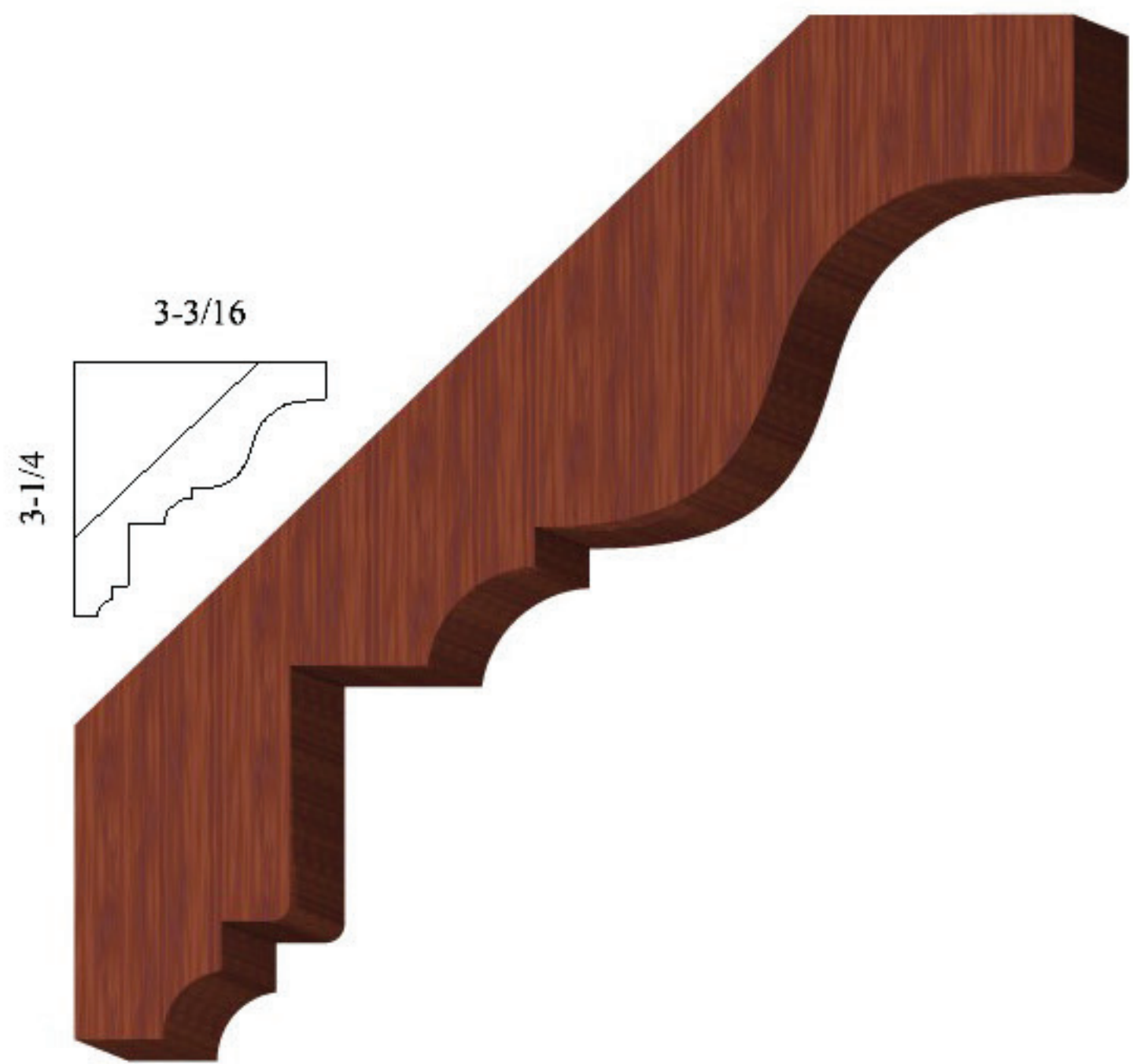

CR193
7/8 x 4-1/4

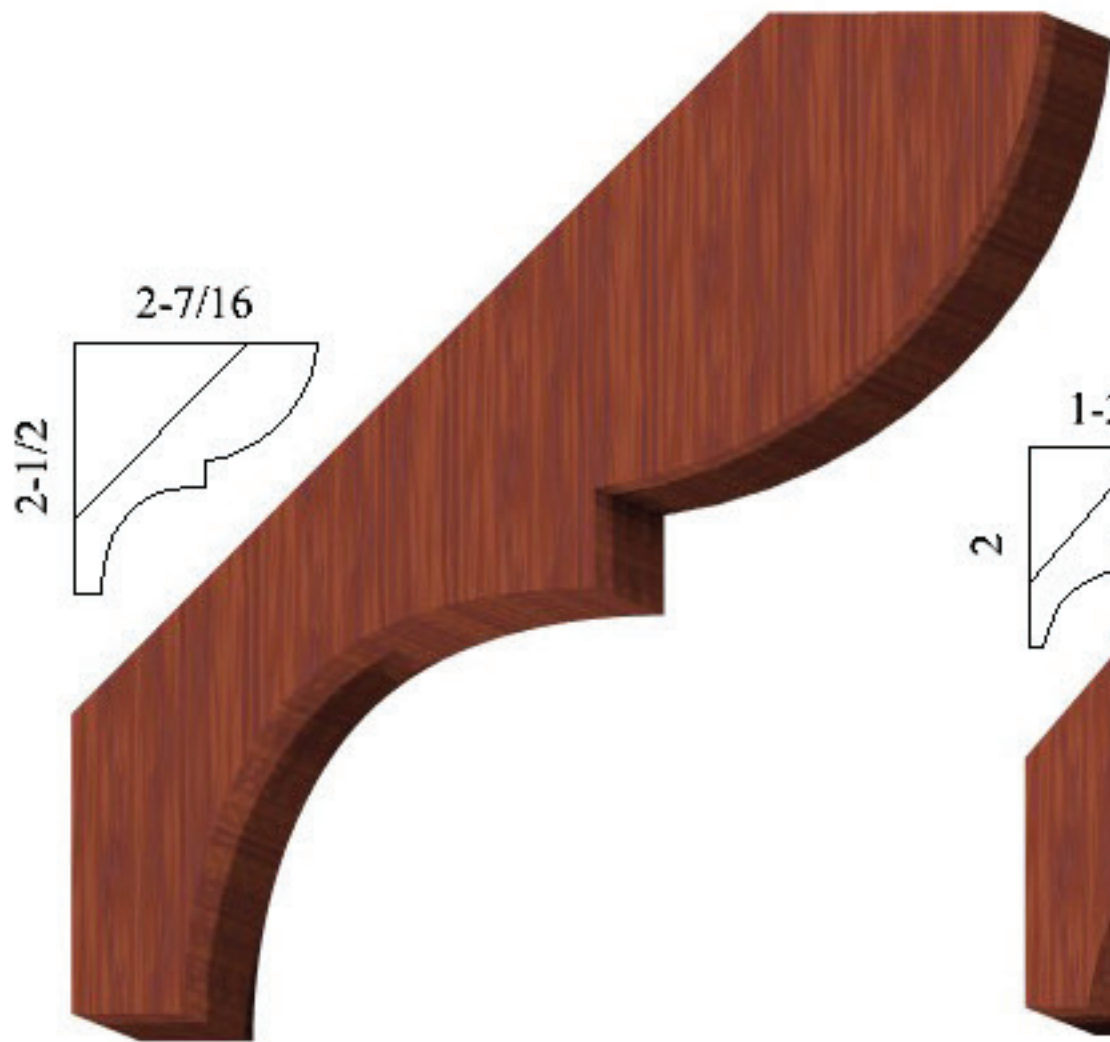

CR45
3/4 x 3-1/2

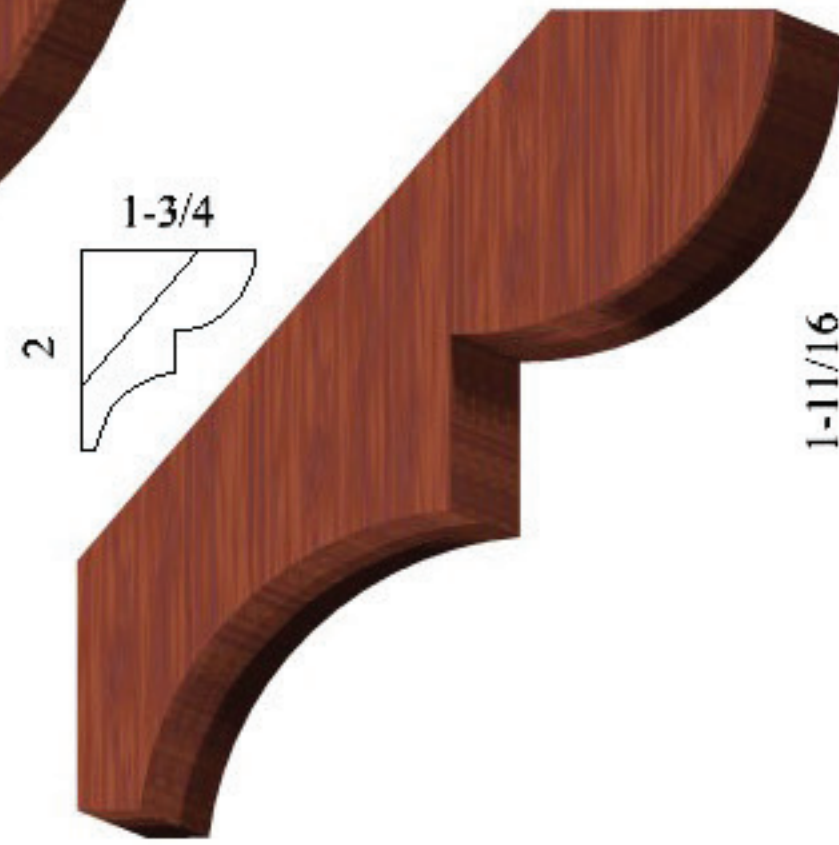

CR48
5/8 x 2-5/8

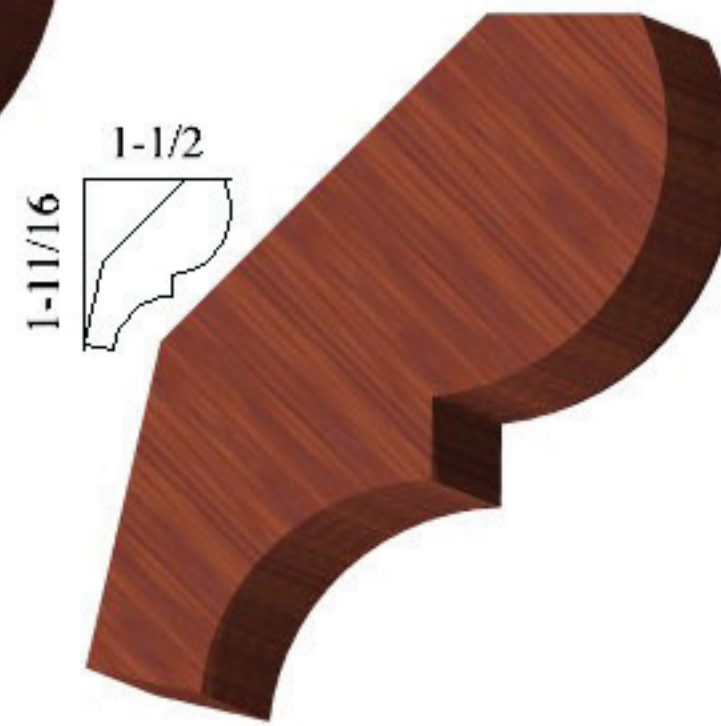

CR219
3/4 x 2-1/8

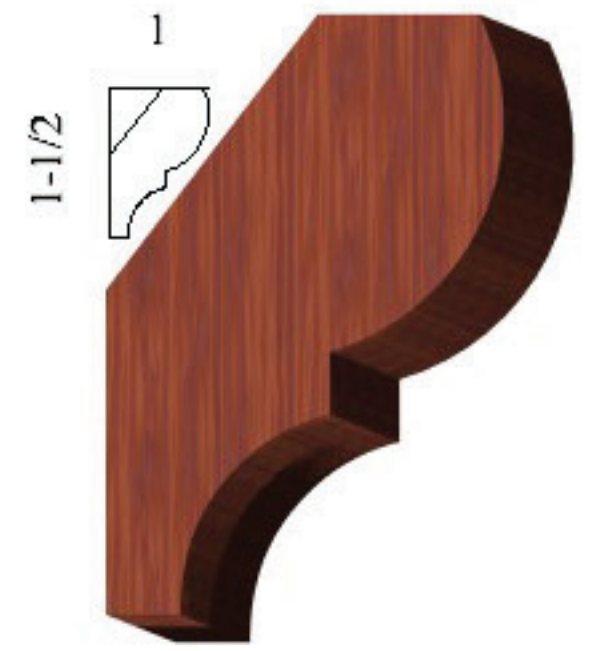

CR49
9/16 x 1-13/16

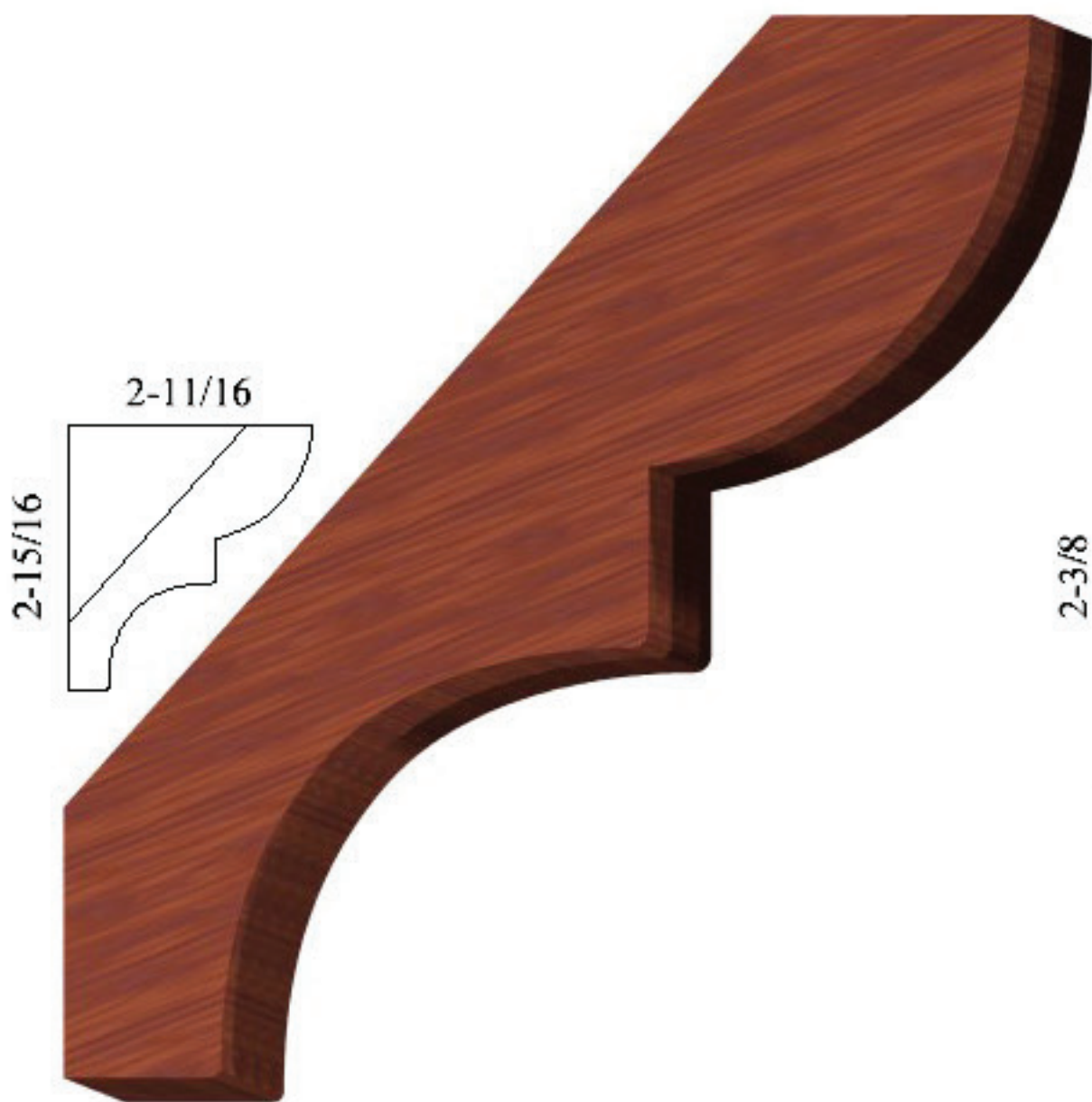

CR123
13/16 x 3-15/16

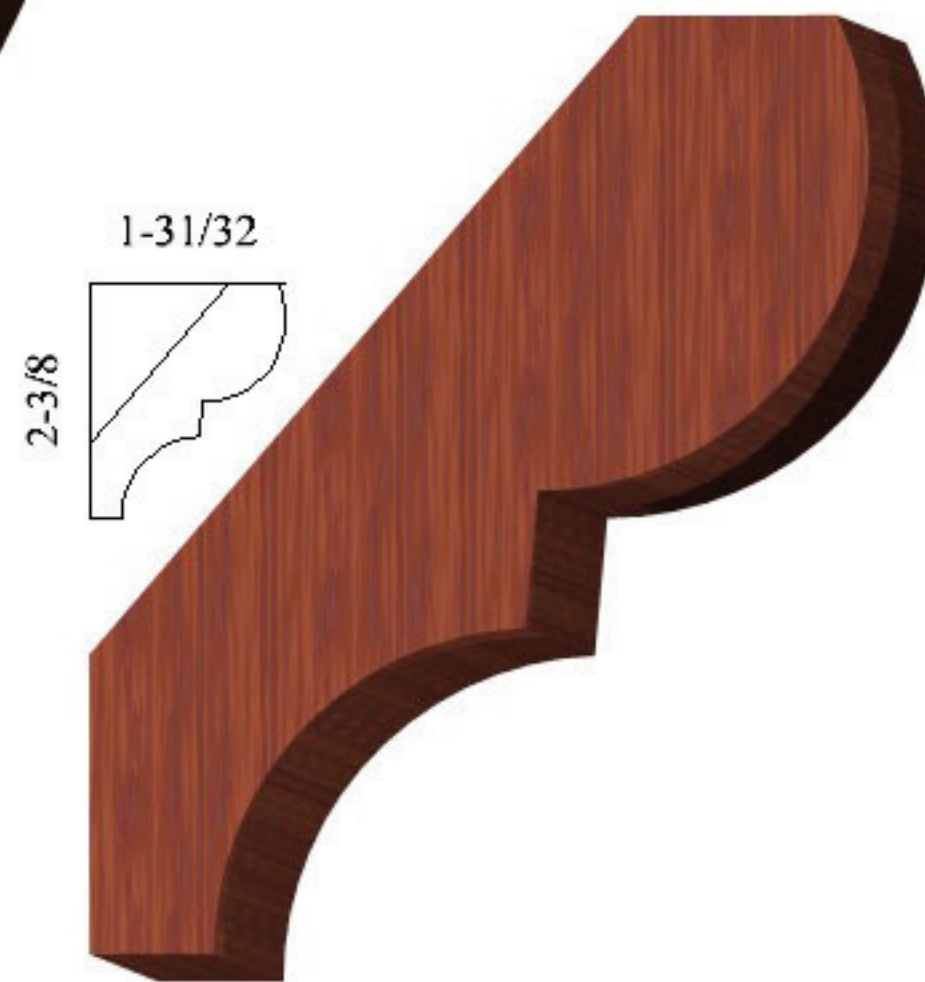

CR115
1-3/16 x 3

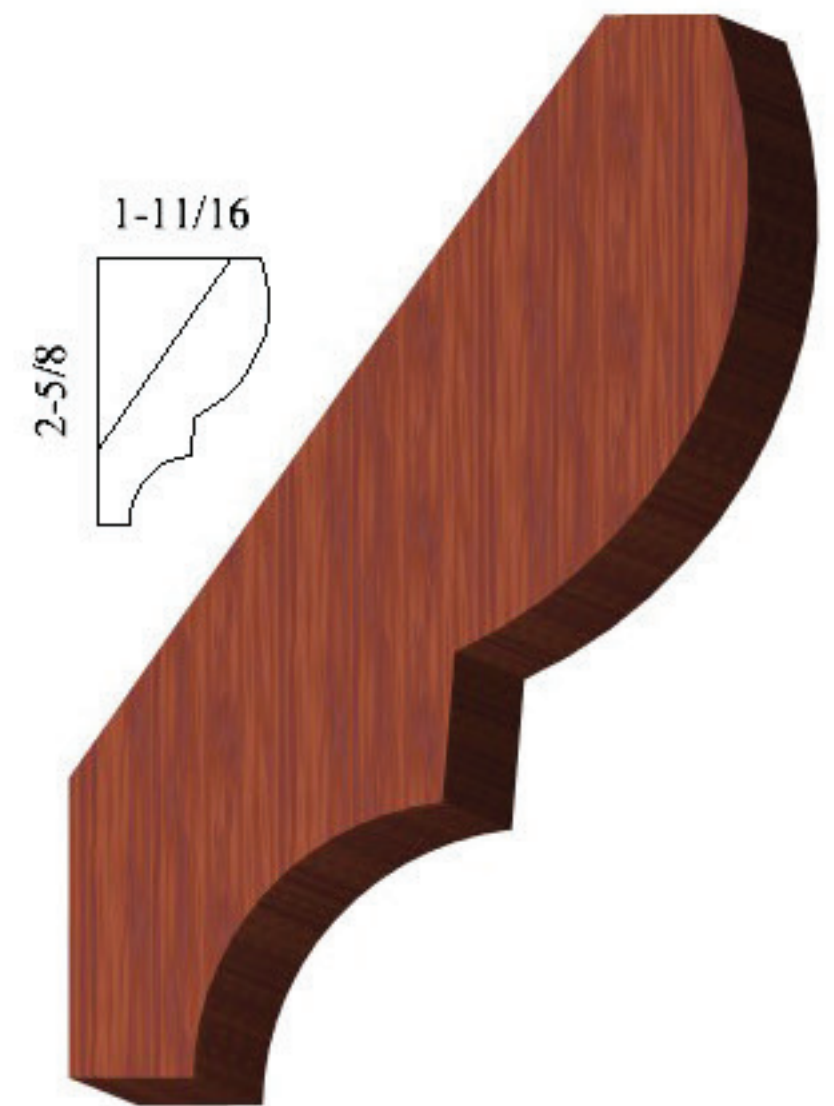

CR128
3/4 x 3-1/4

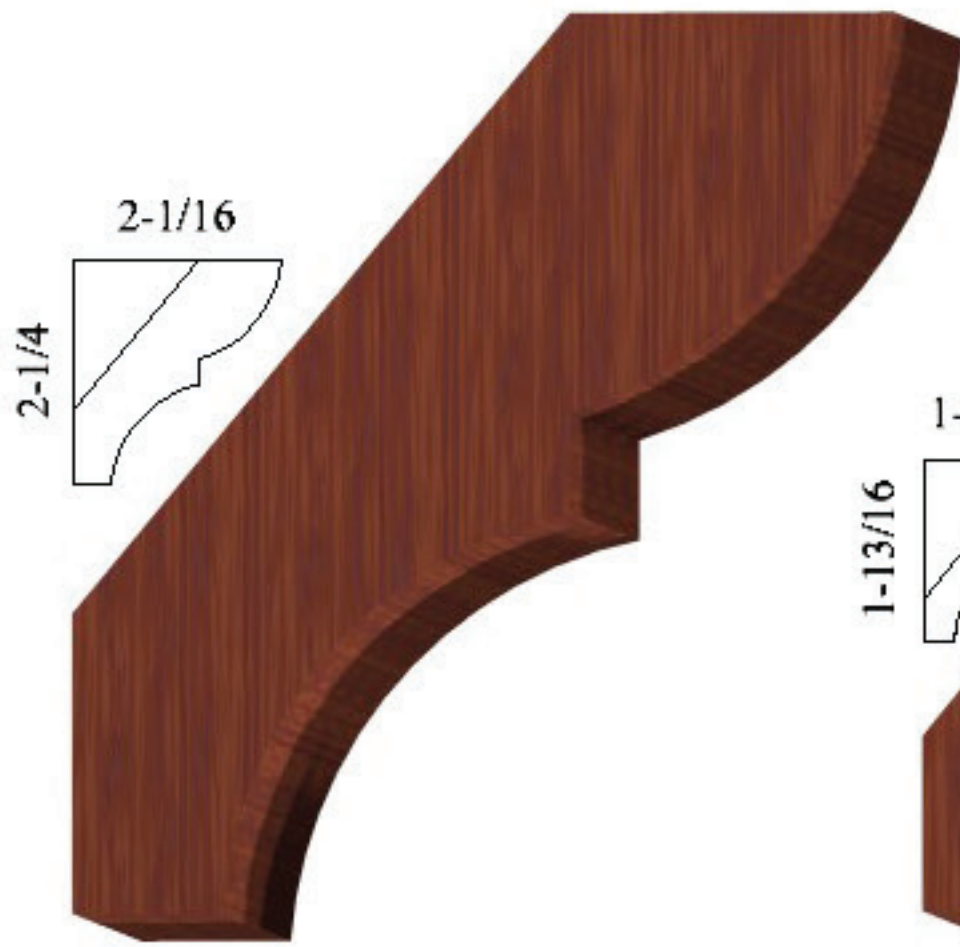

CR148
13/16 x 3-1/16



CR55
1/2 x 2-1/4

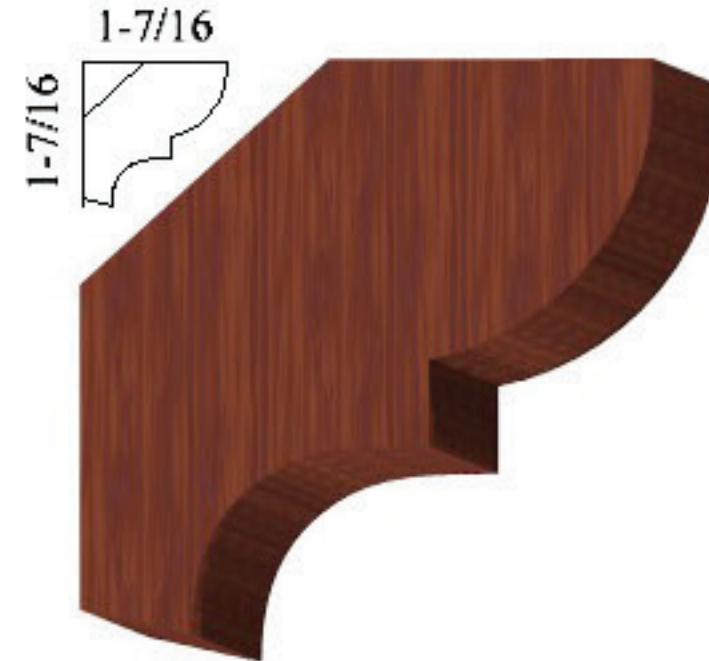

CR74
7/8 x 1-7/16

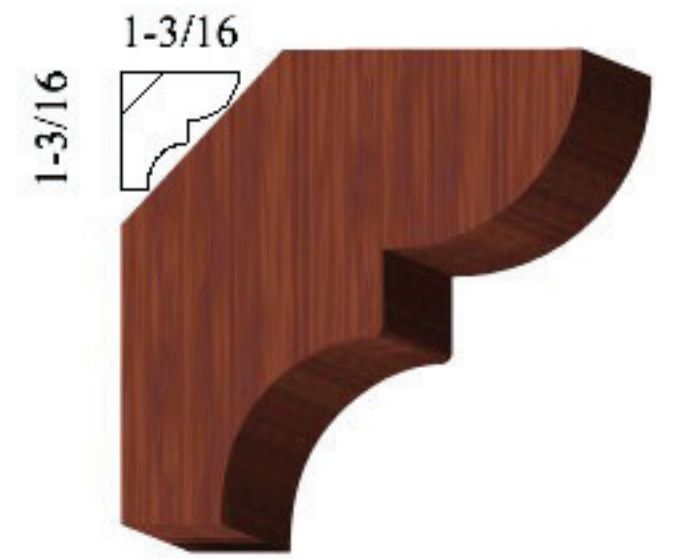

CR65
3/4 x 1-11/16

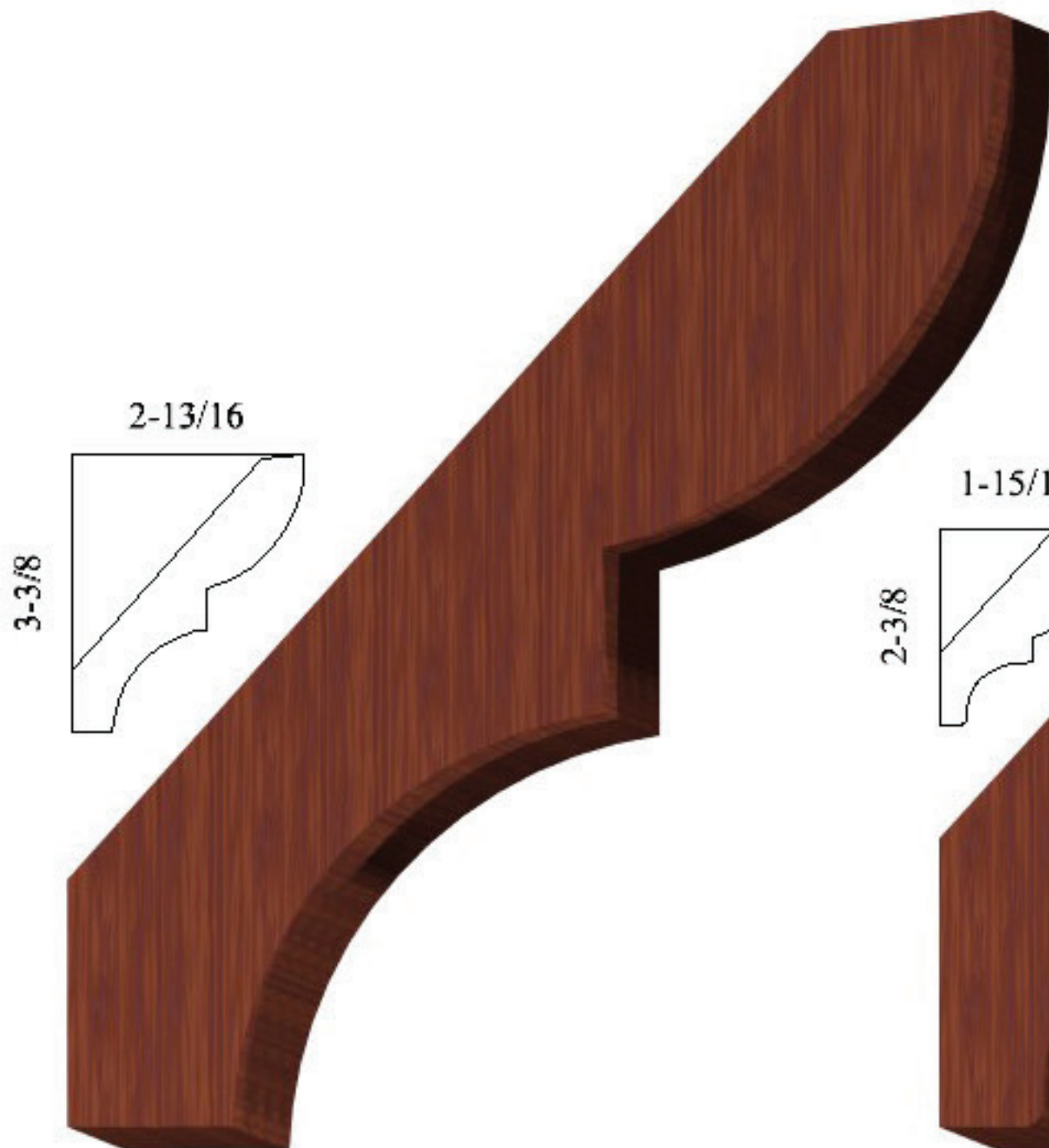

CR207
7/8 x 4-7/16

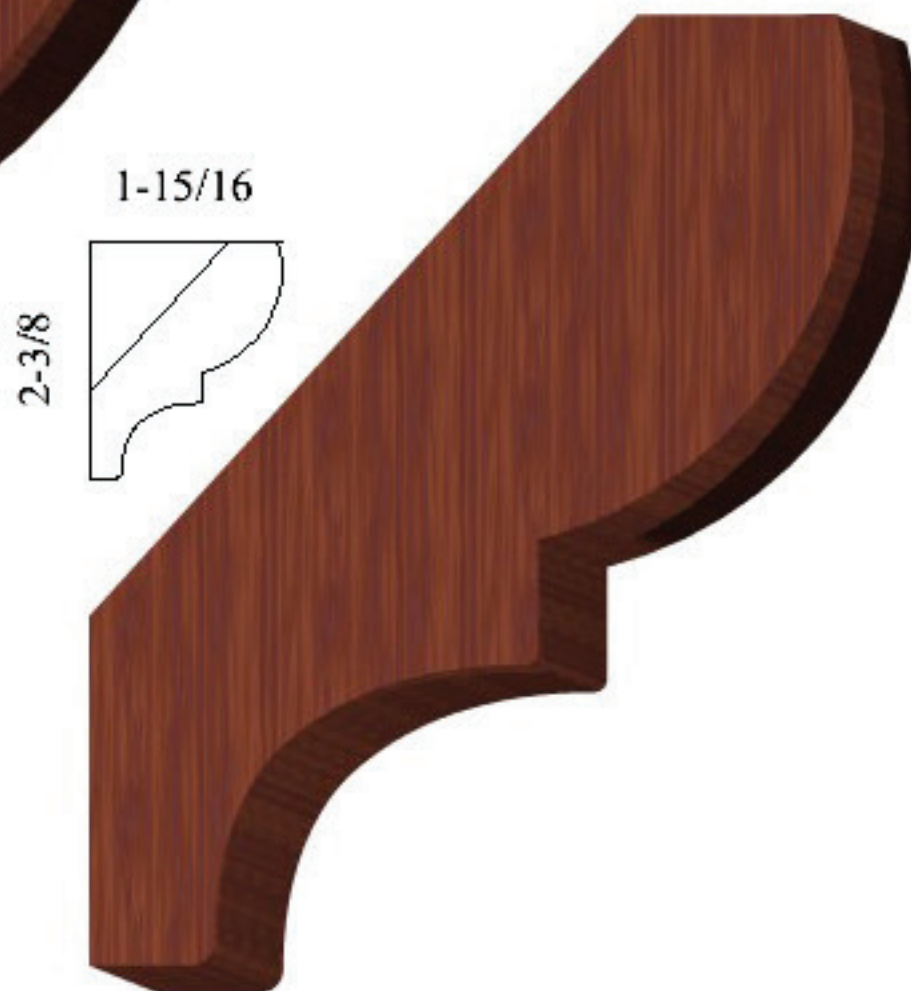

CR117
13/16 x 3

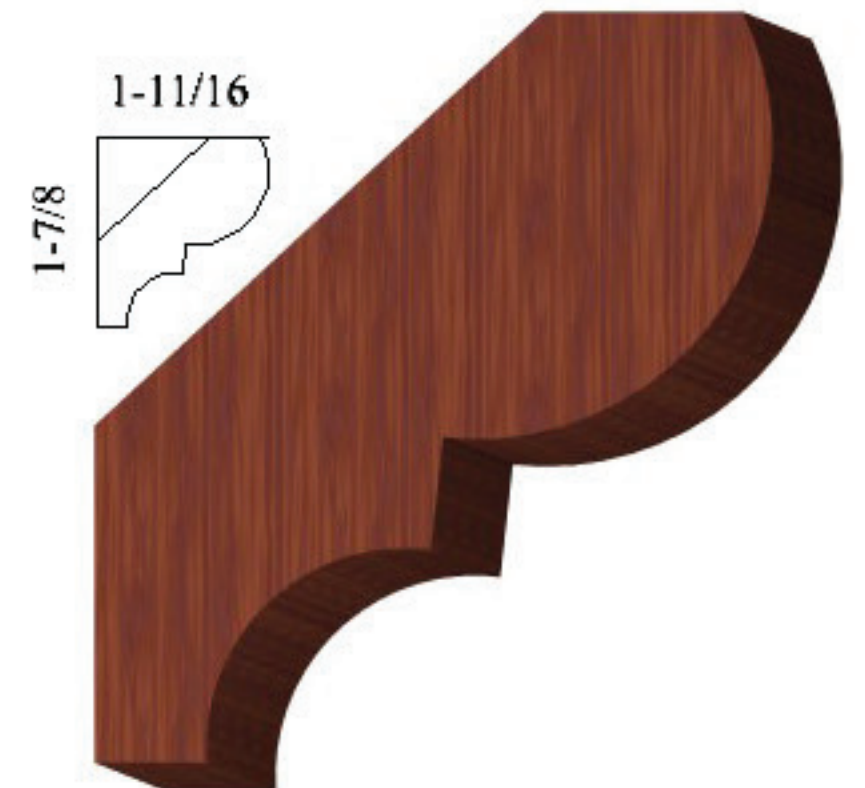

CR152
7/8 x 2-1/4

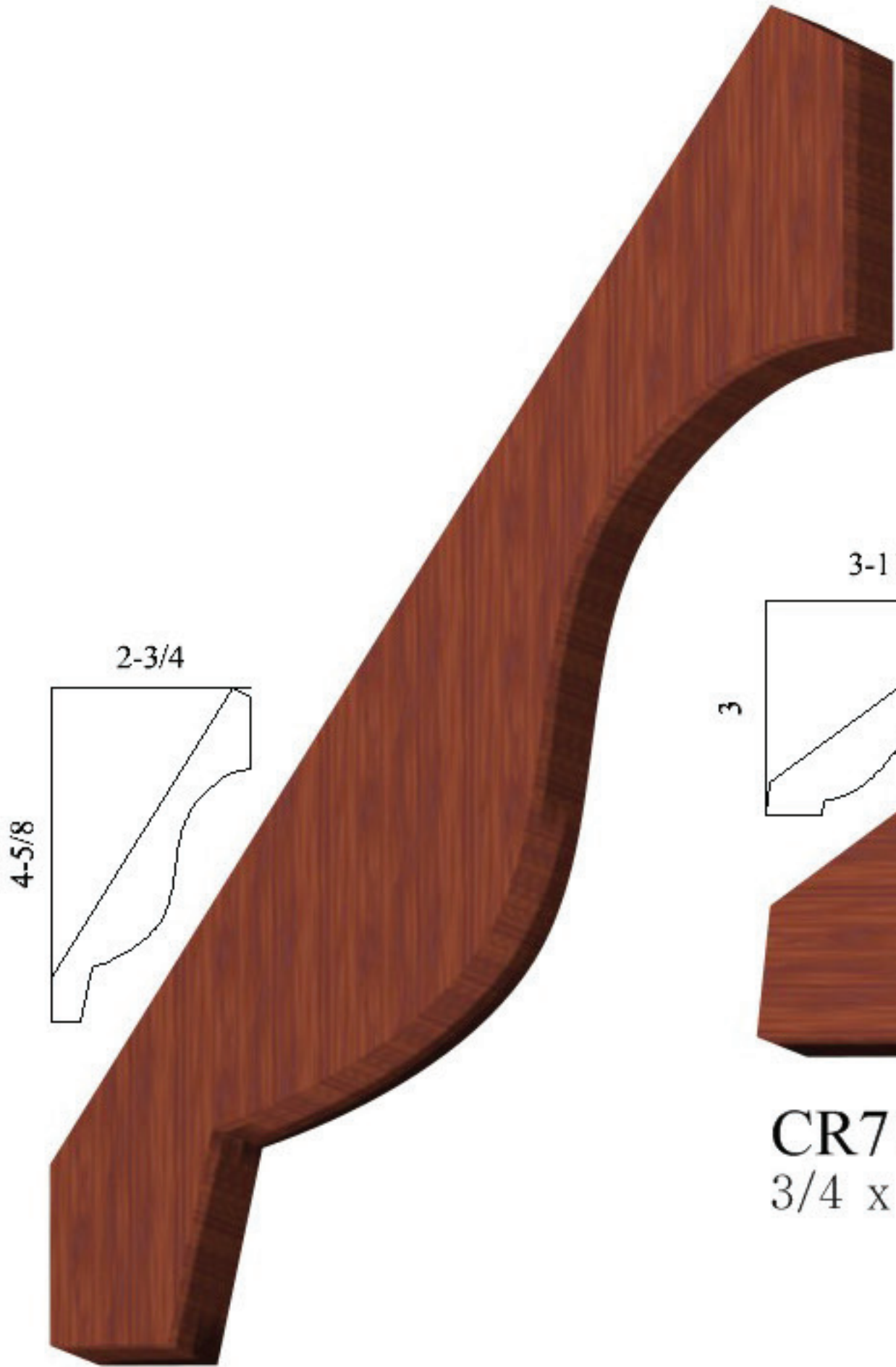

CR34
7/8 x 5-5/16

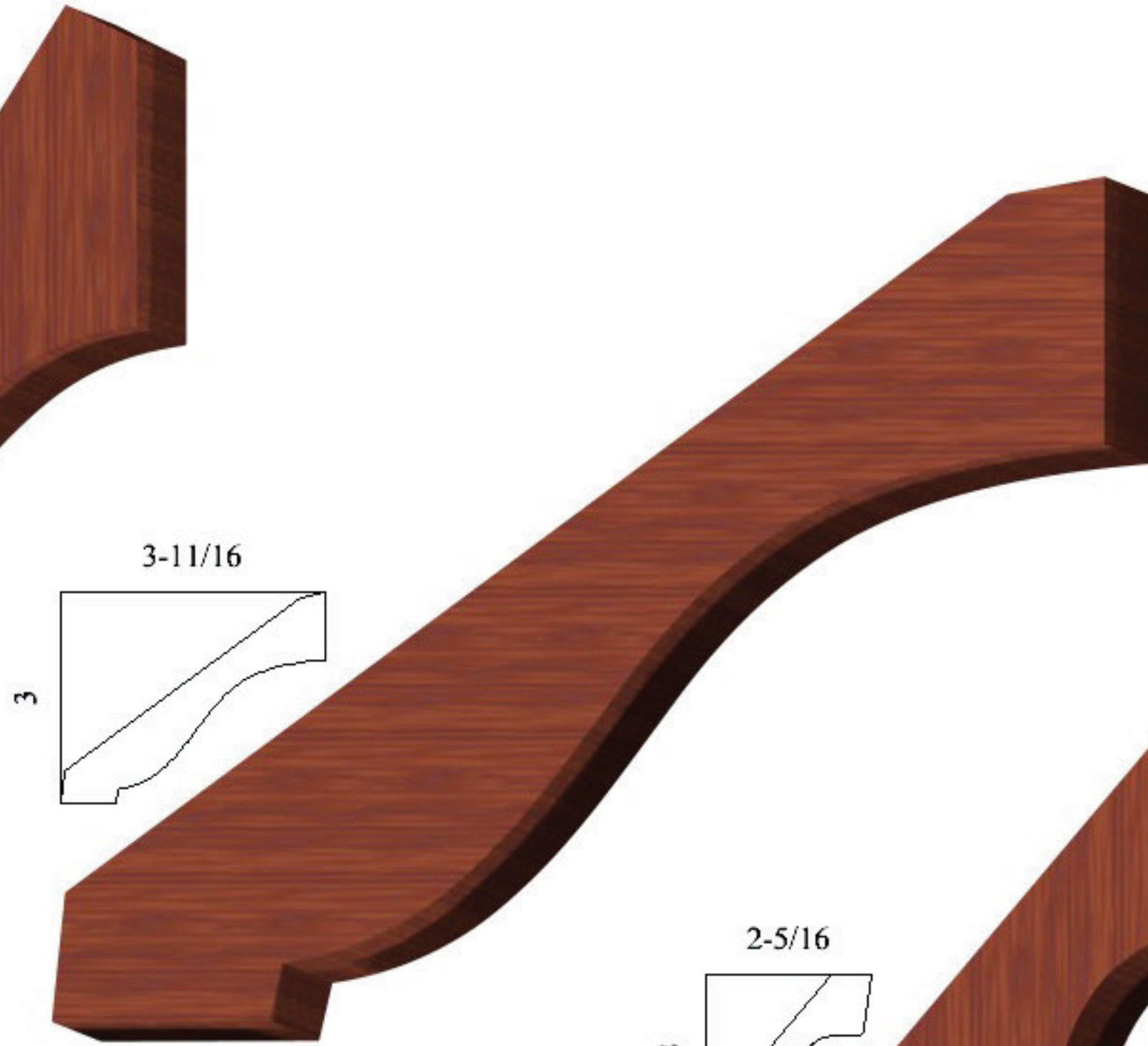

CR71
3/4 x 4-3/4

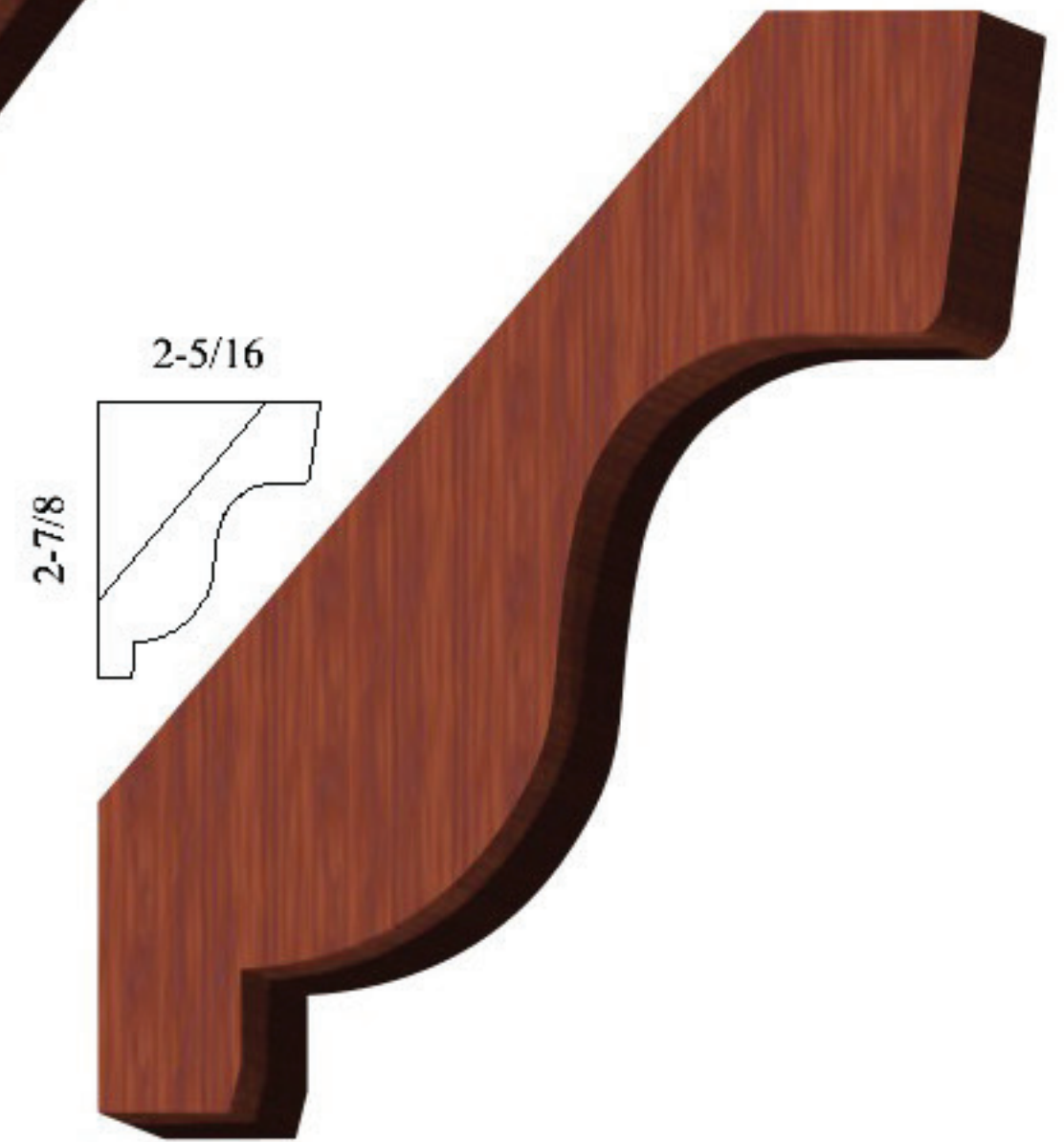

CR81
7/8 x 3-11/16

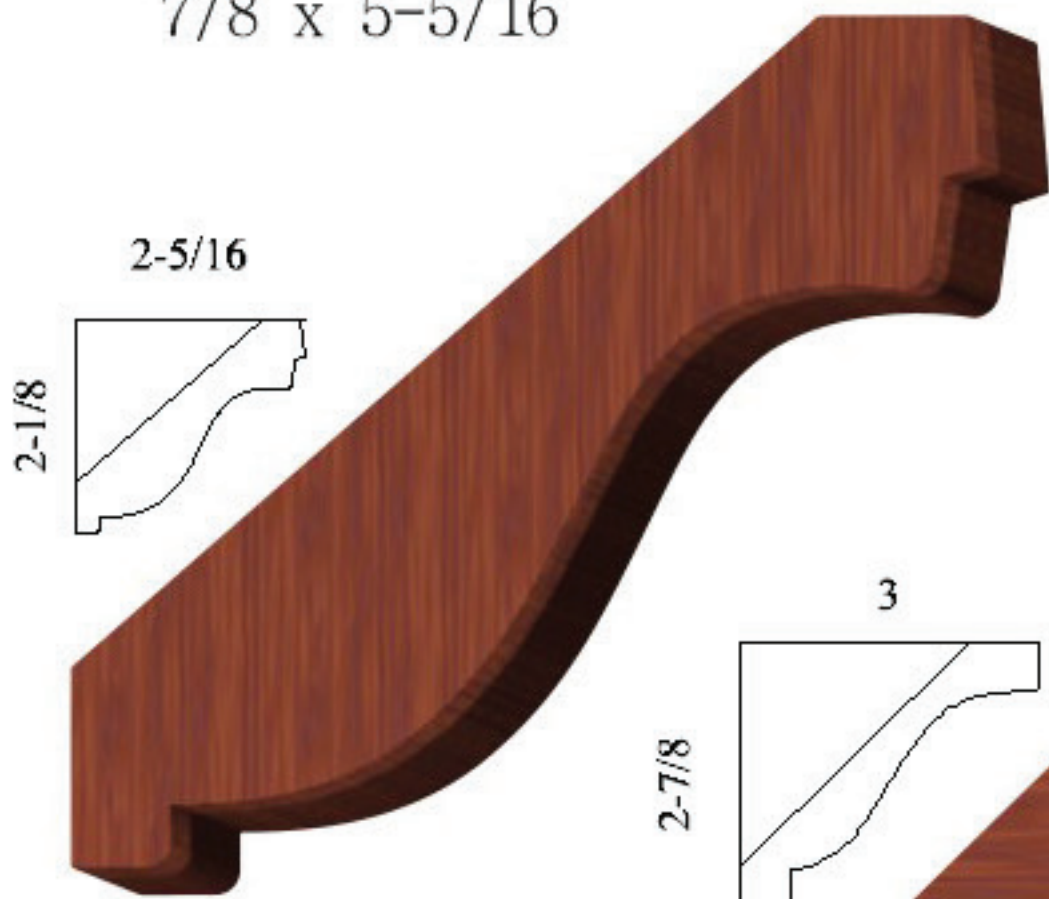

CR96
5/8 x 3-1/8

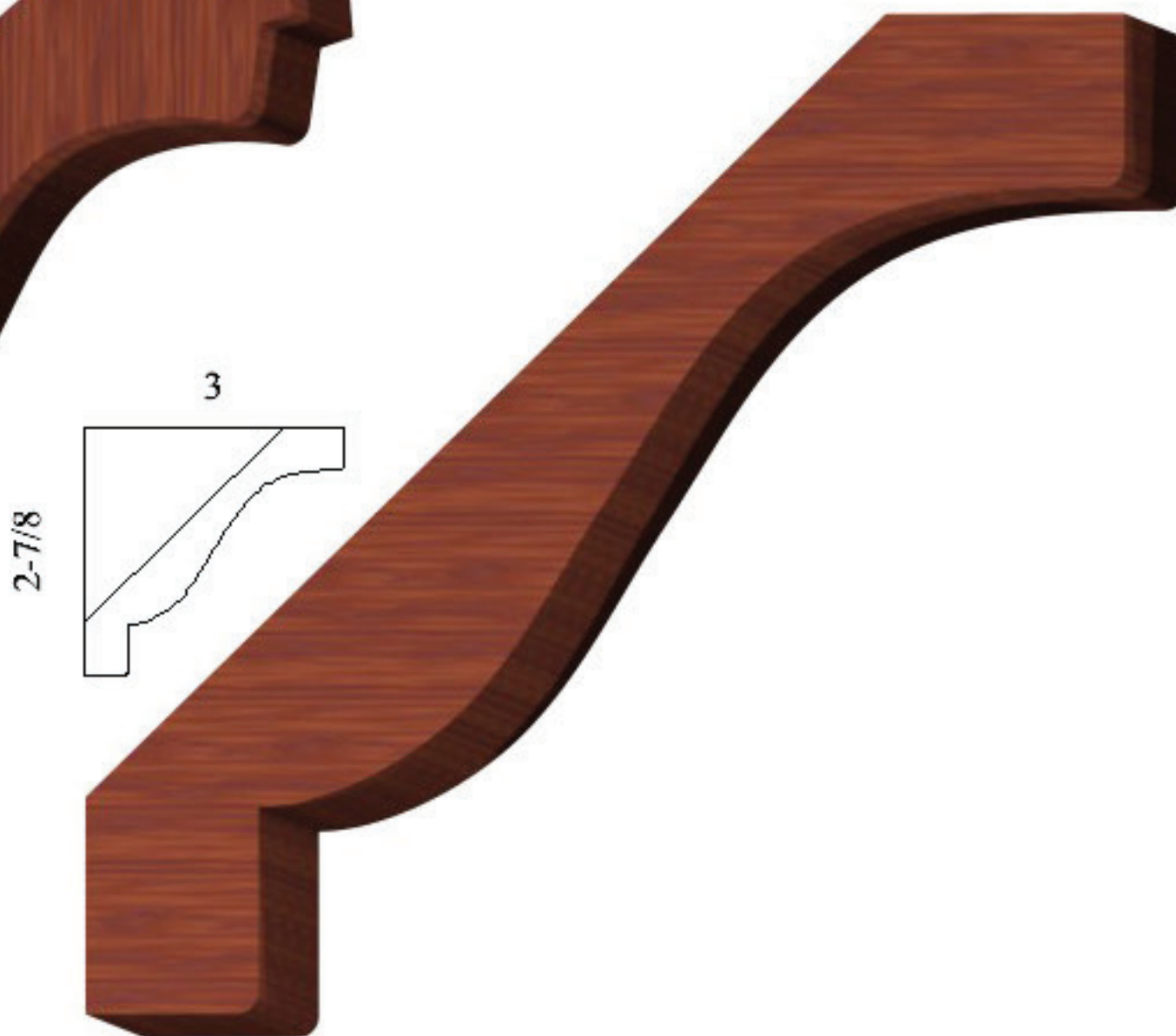

CR93
9/16 x 4-3/16

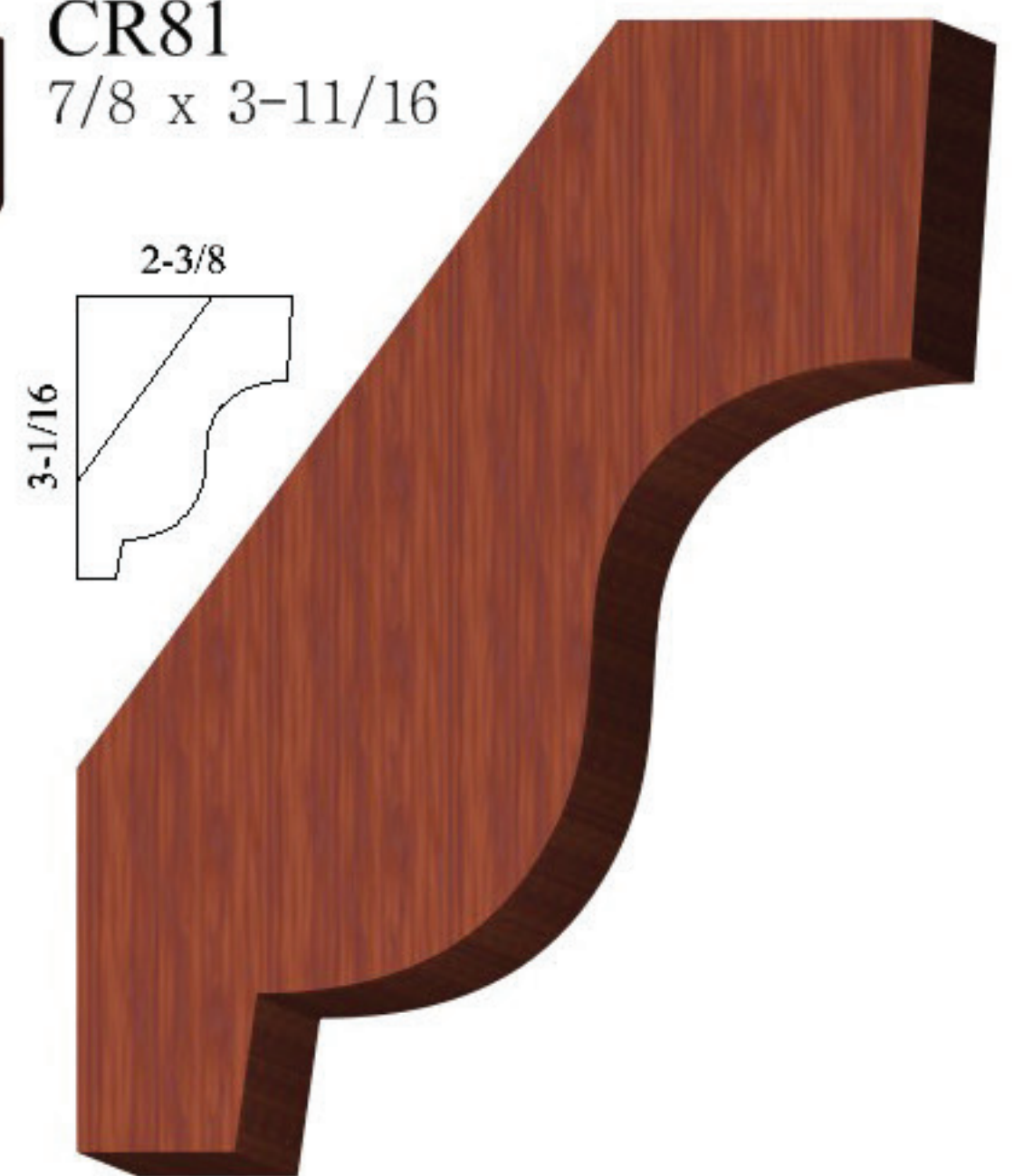

CR136
13/16 x 4

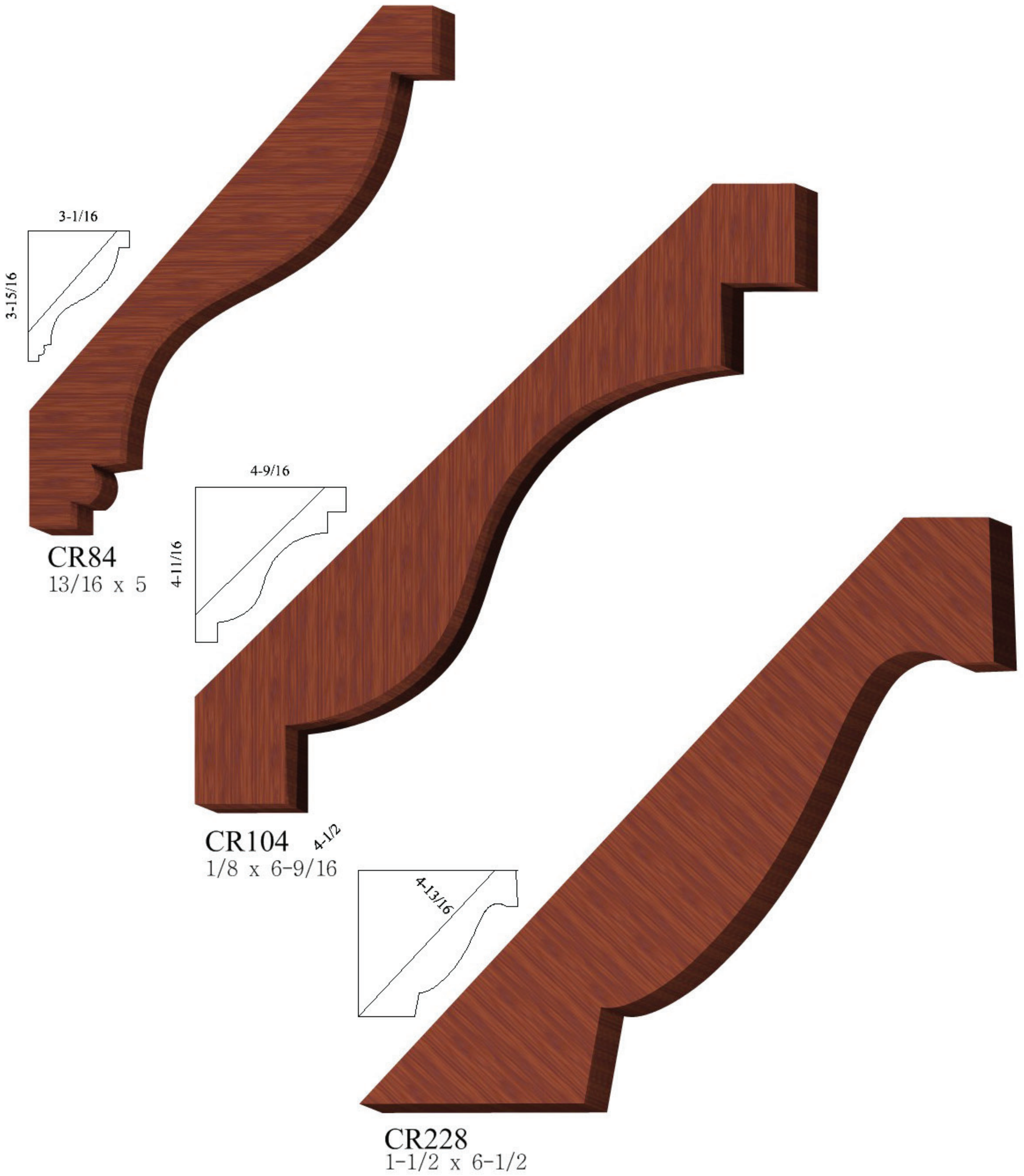

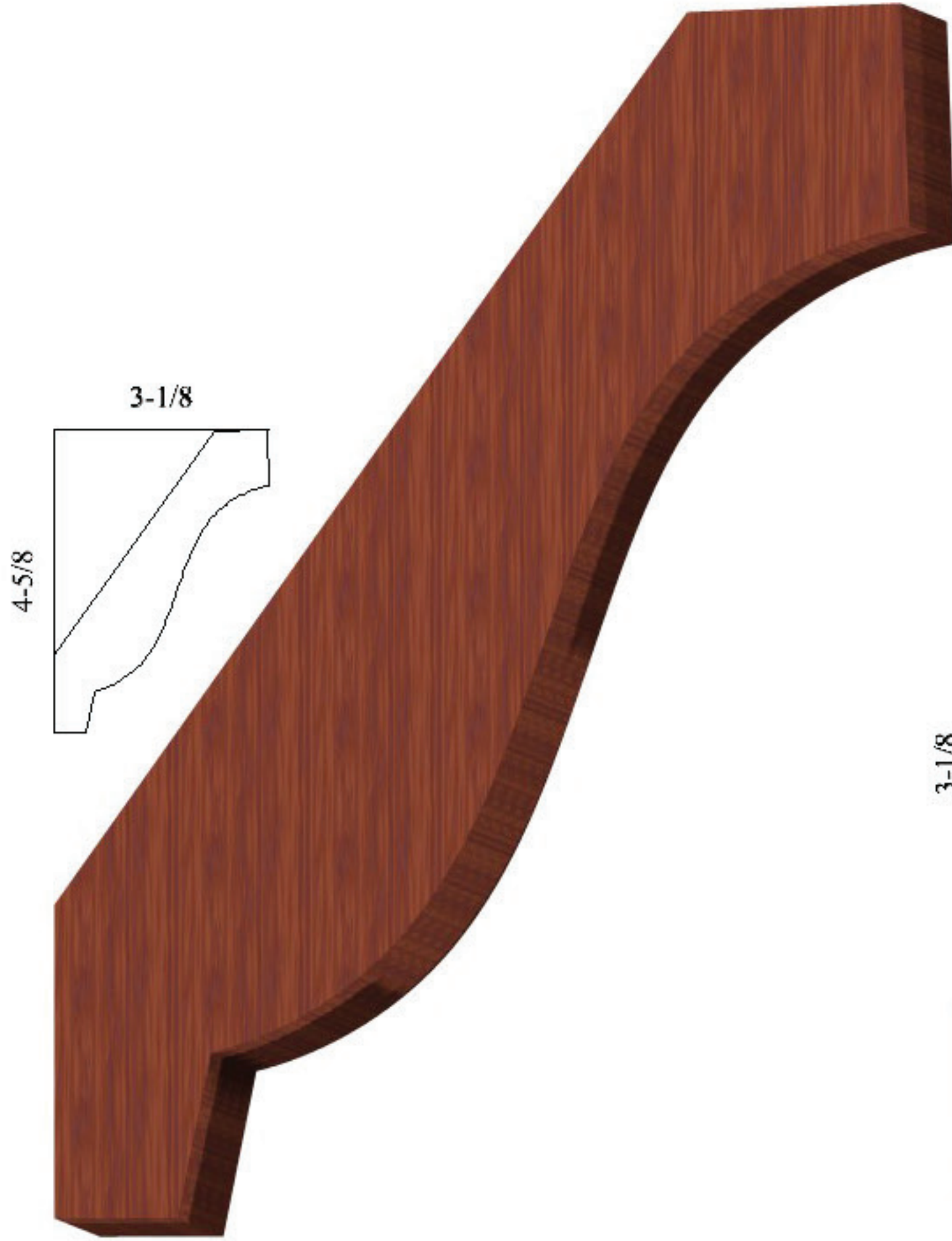

CR192
1-1/8 x 5-9/16

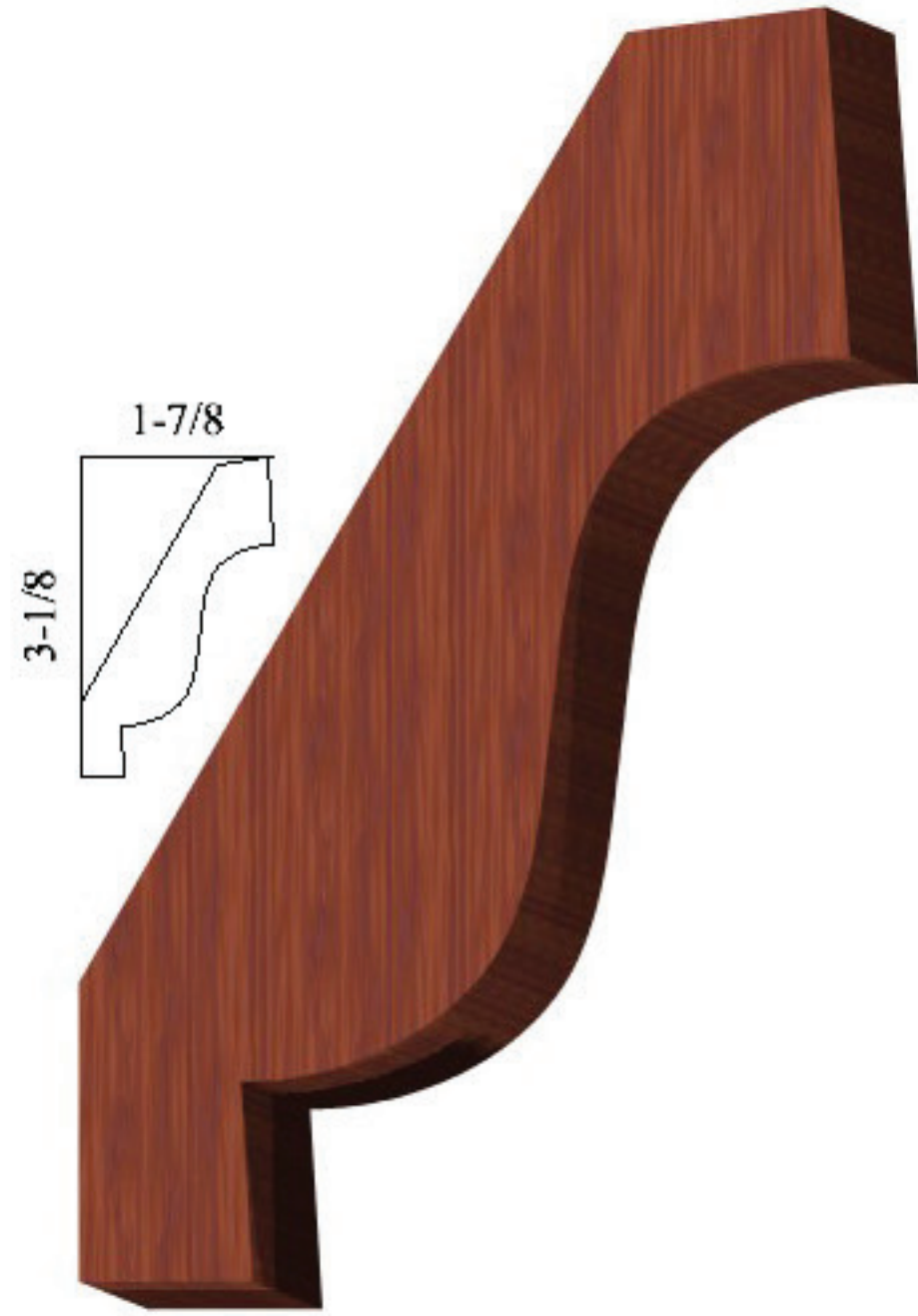

CR153
7/8 x 3-11/16

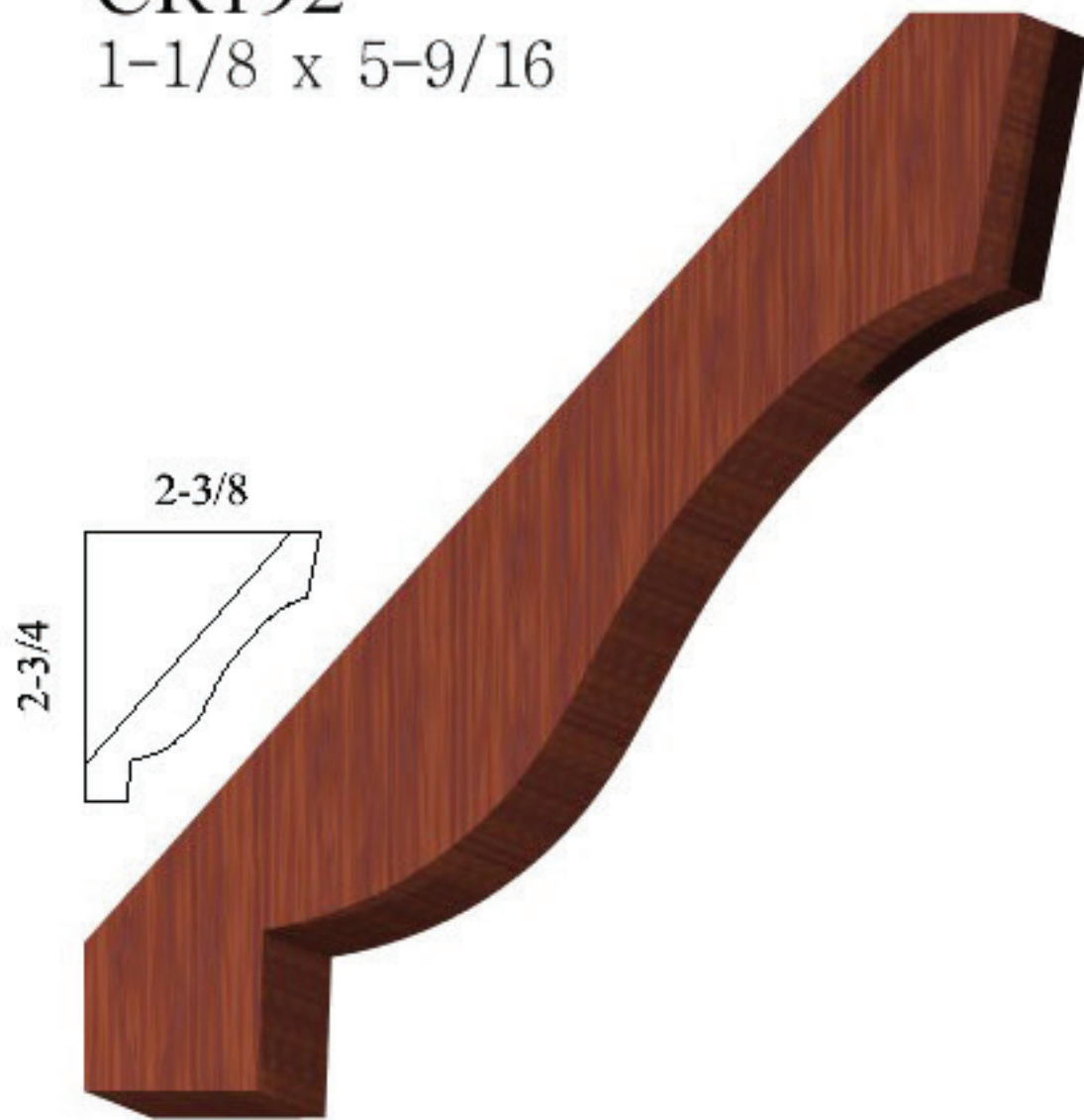

CR157
9/16 x 3-5/8

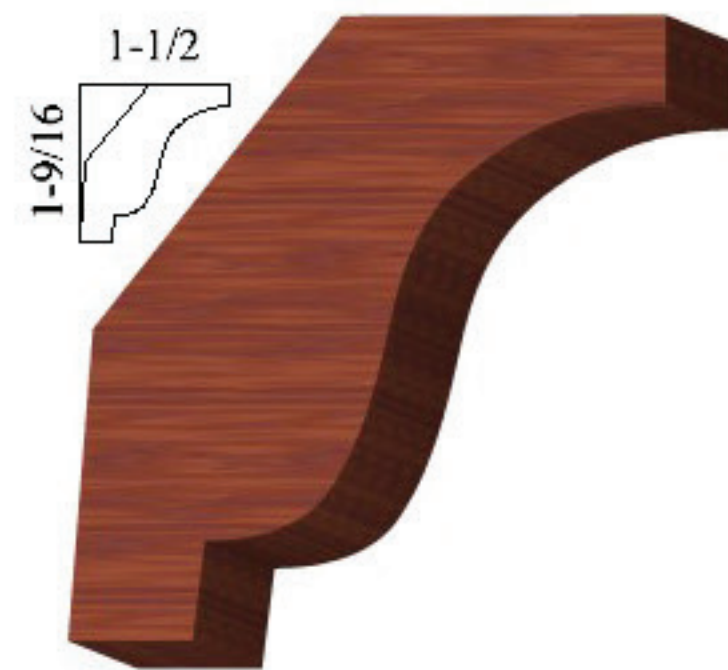

CR141
3/4 x 2-1/8

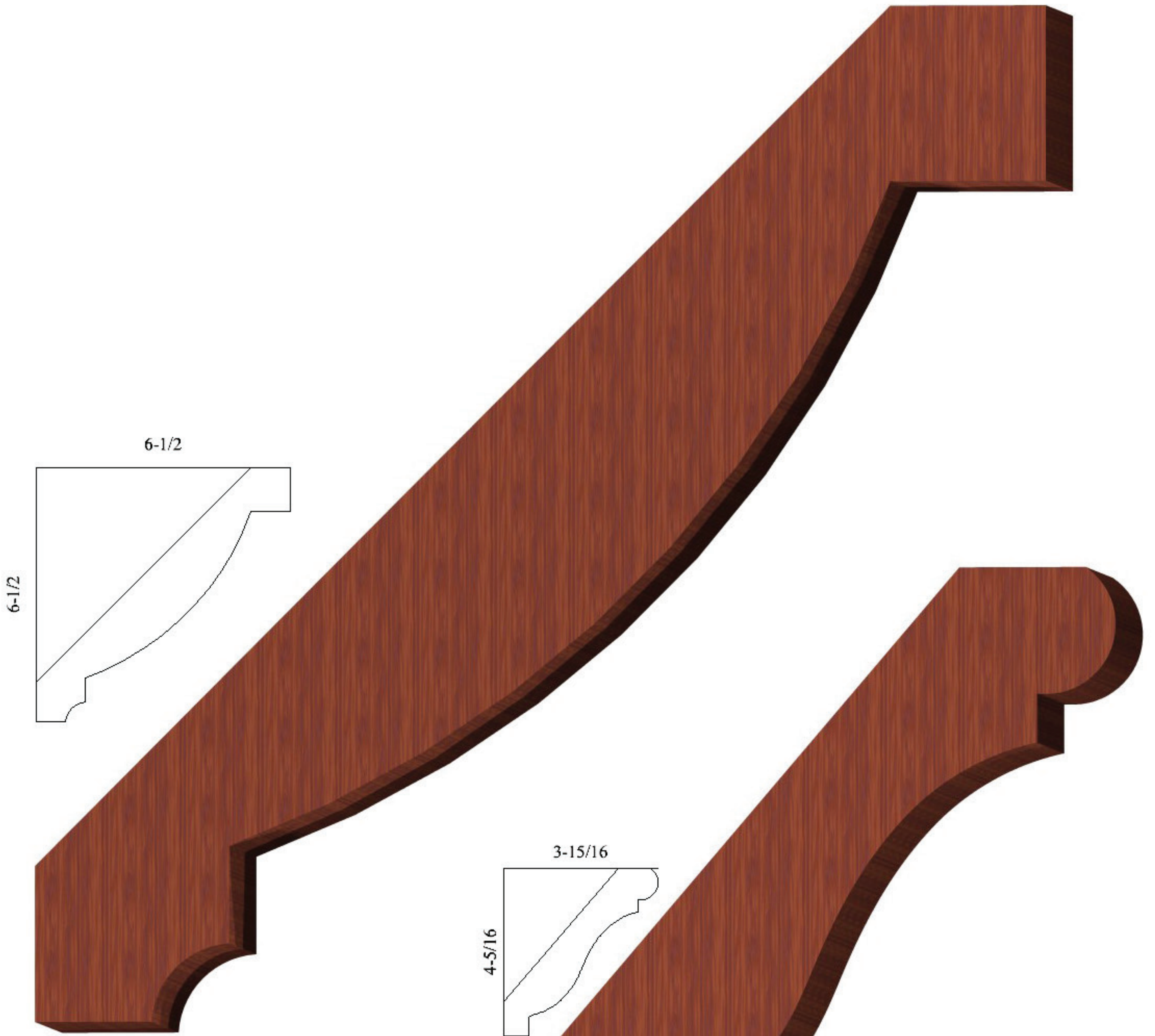

CR198
1-1/2 x 9-1/4

CR205
1-1/8 x 5-3/4

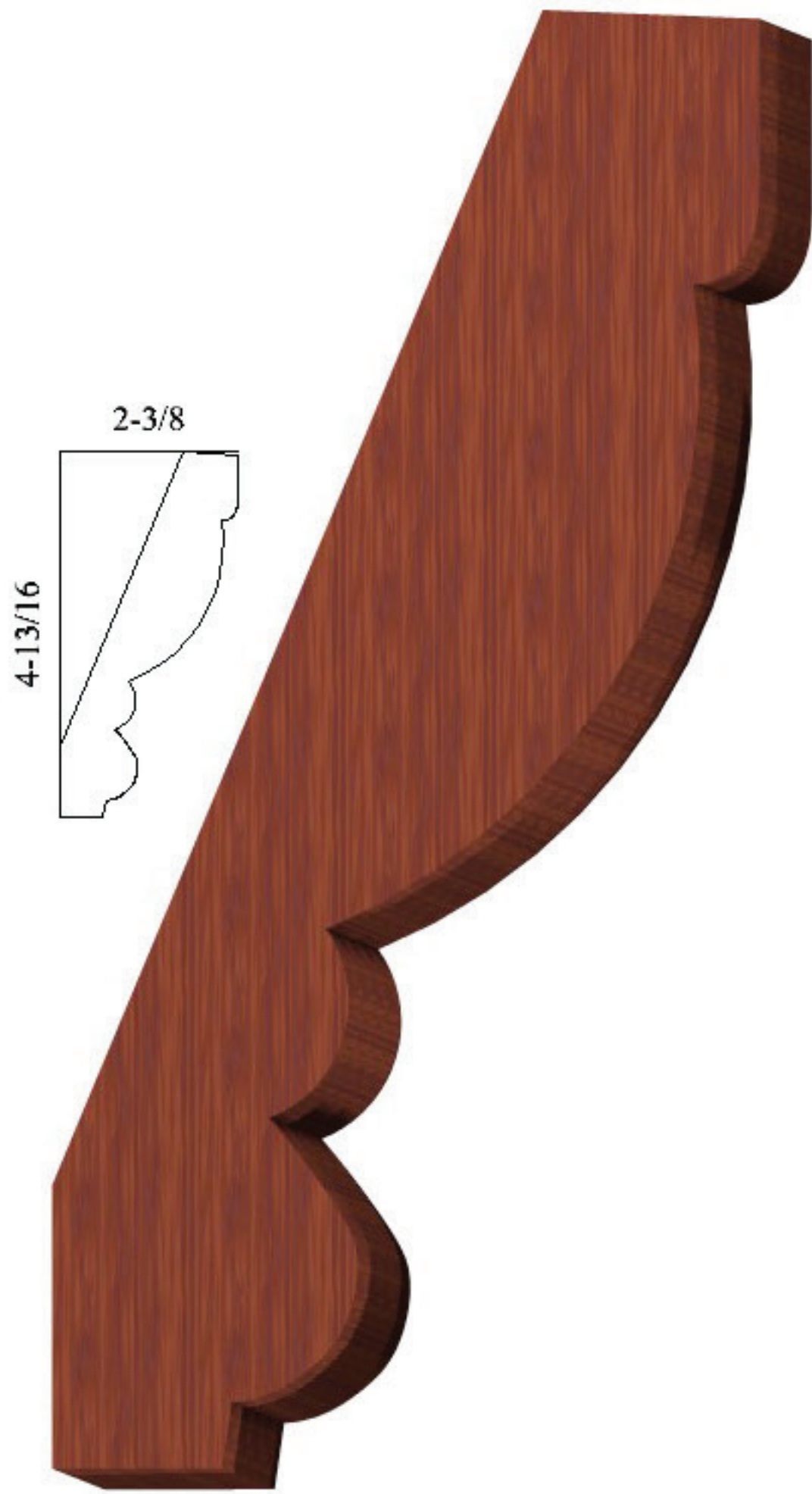

CR50
1-1/16 x 5-5/16

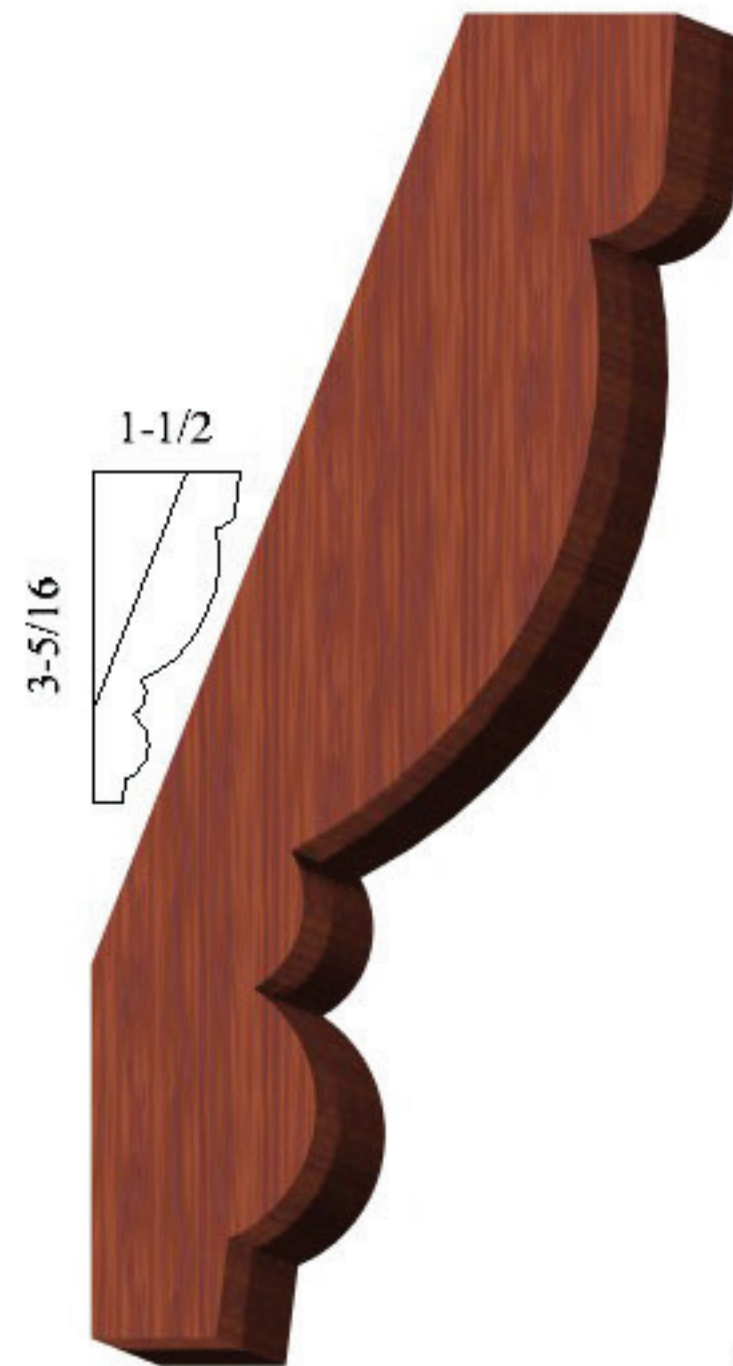

CR24
11/16 x 3-5/8

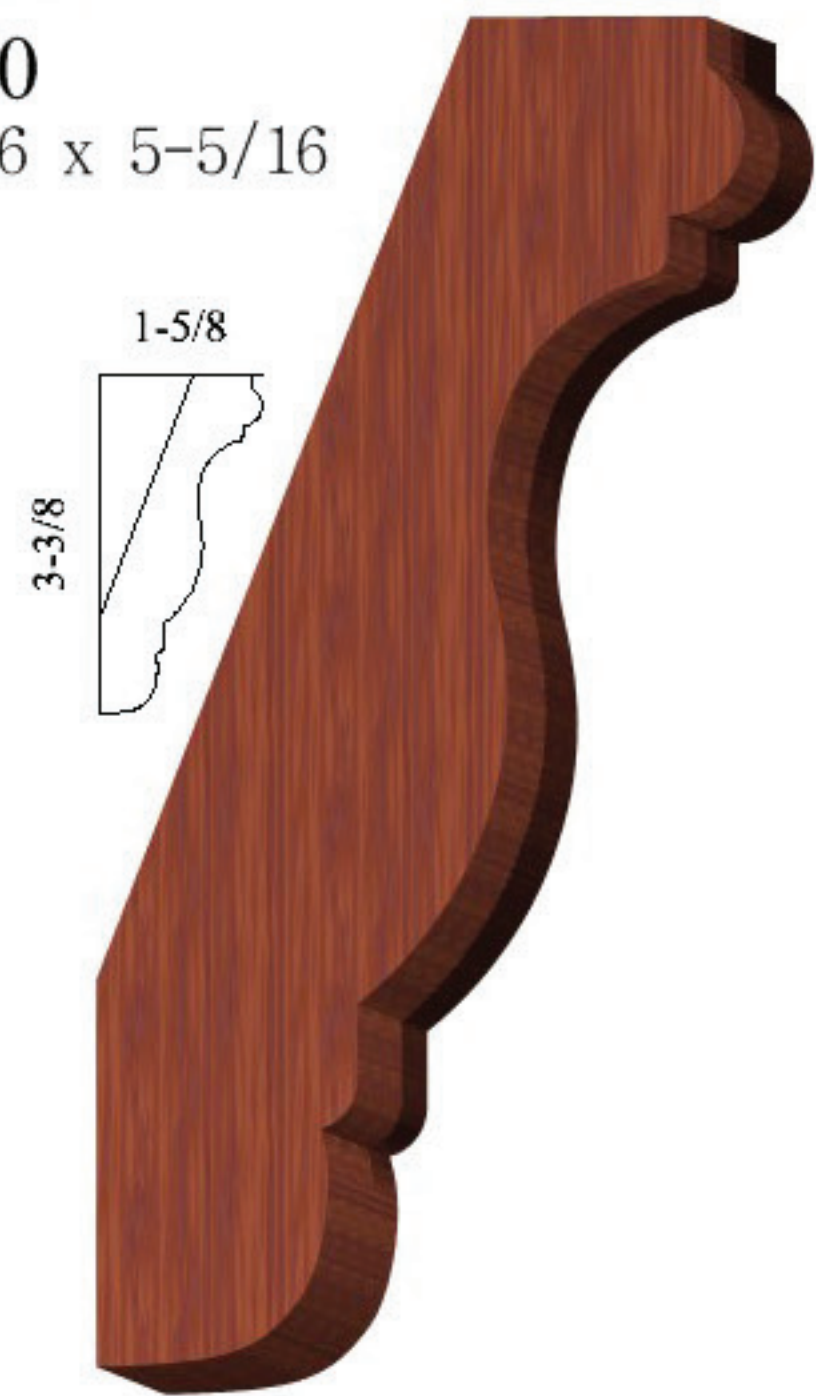

CR75
3/4 x 3-3/4

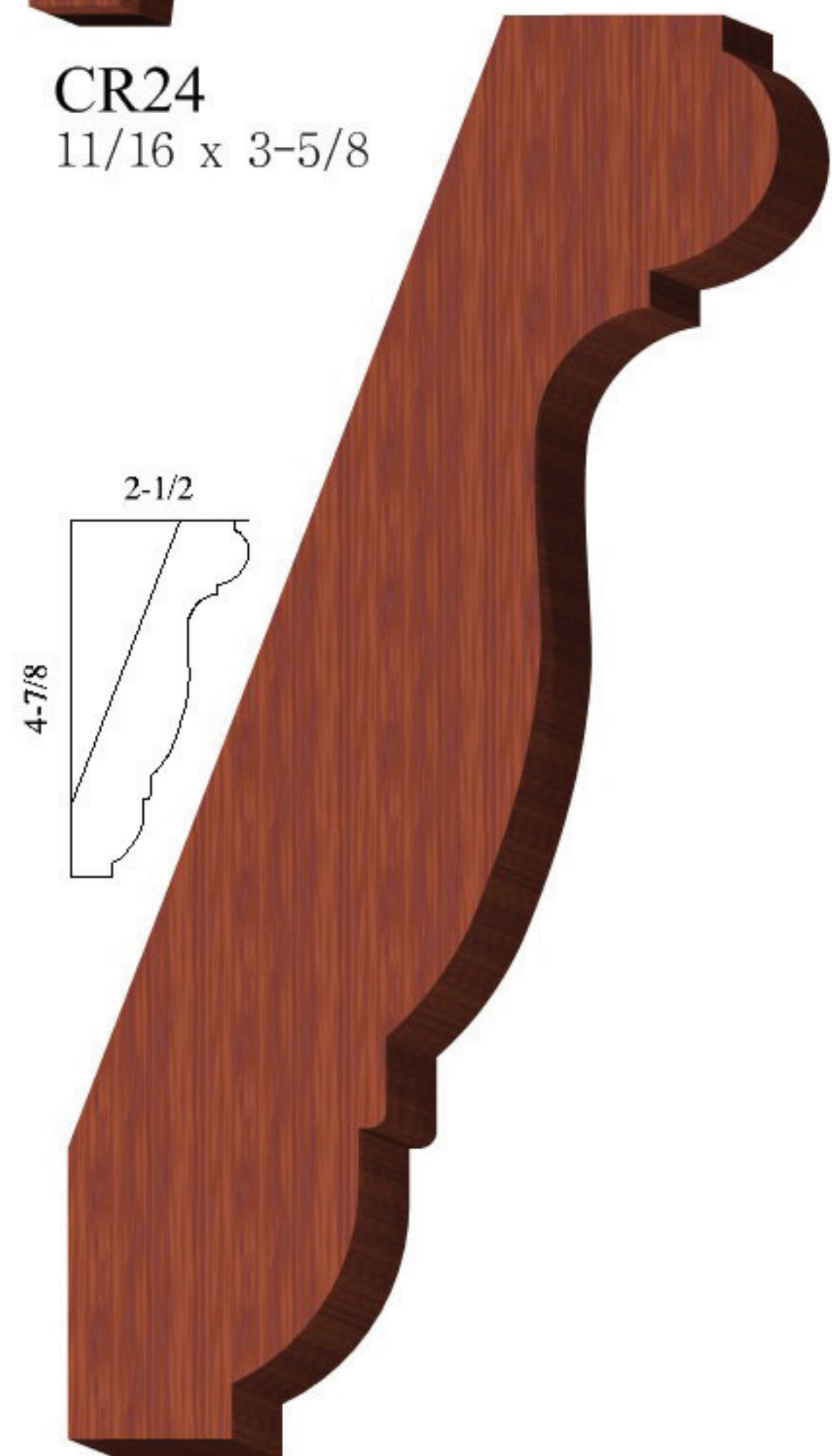

CR77
1/4 x 5-3/8

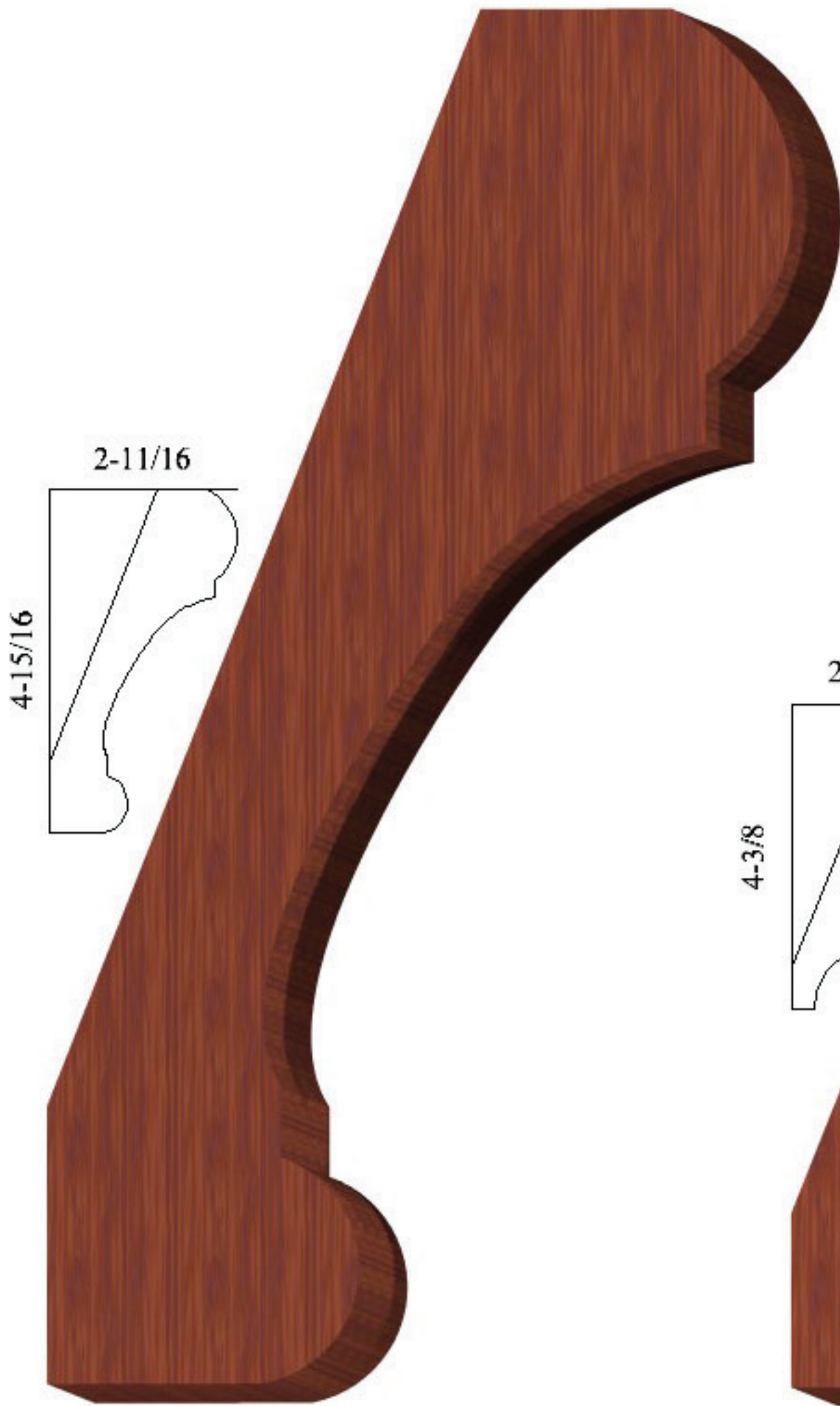

CR105
1-1/4 x 5-3/8

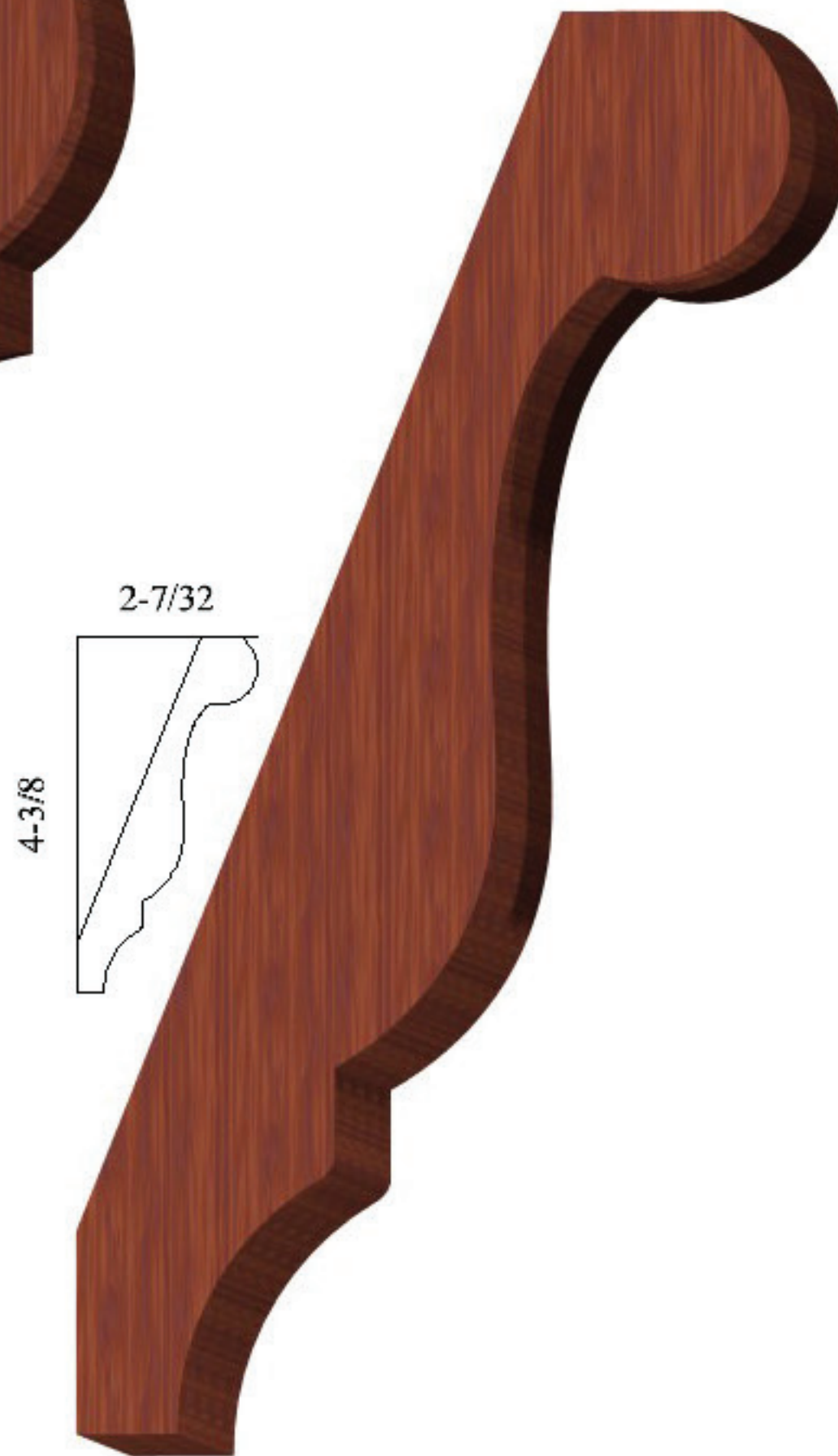

CR107
3/4 x 4-13/16

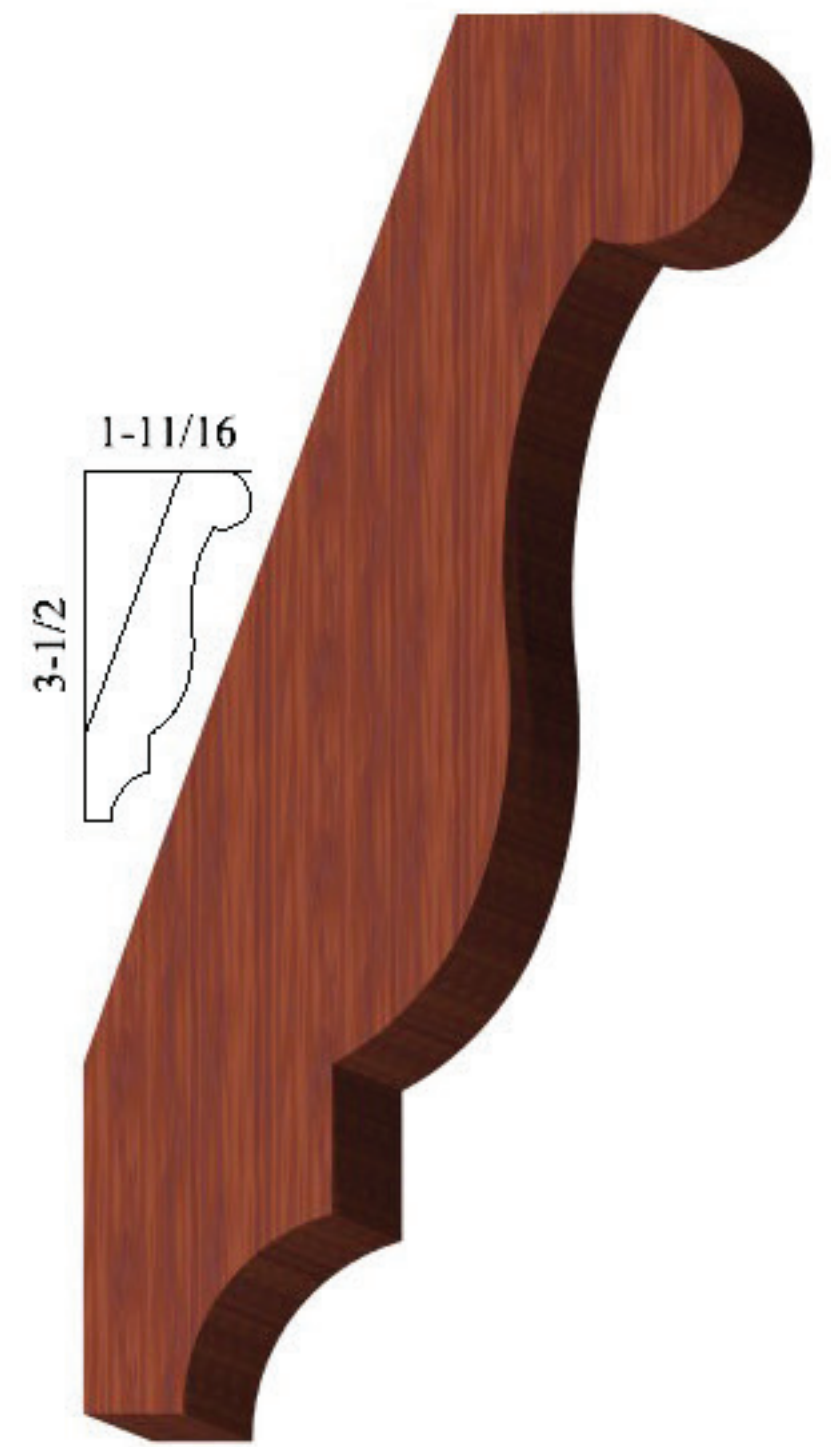

CR111
3/4 x 3-3/4

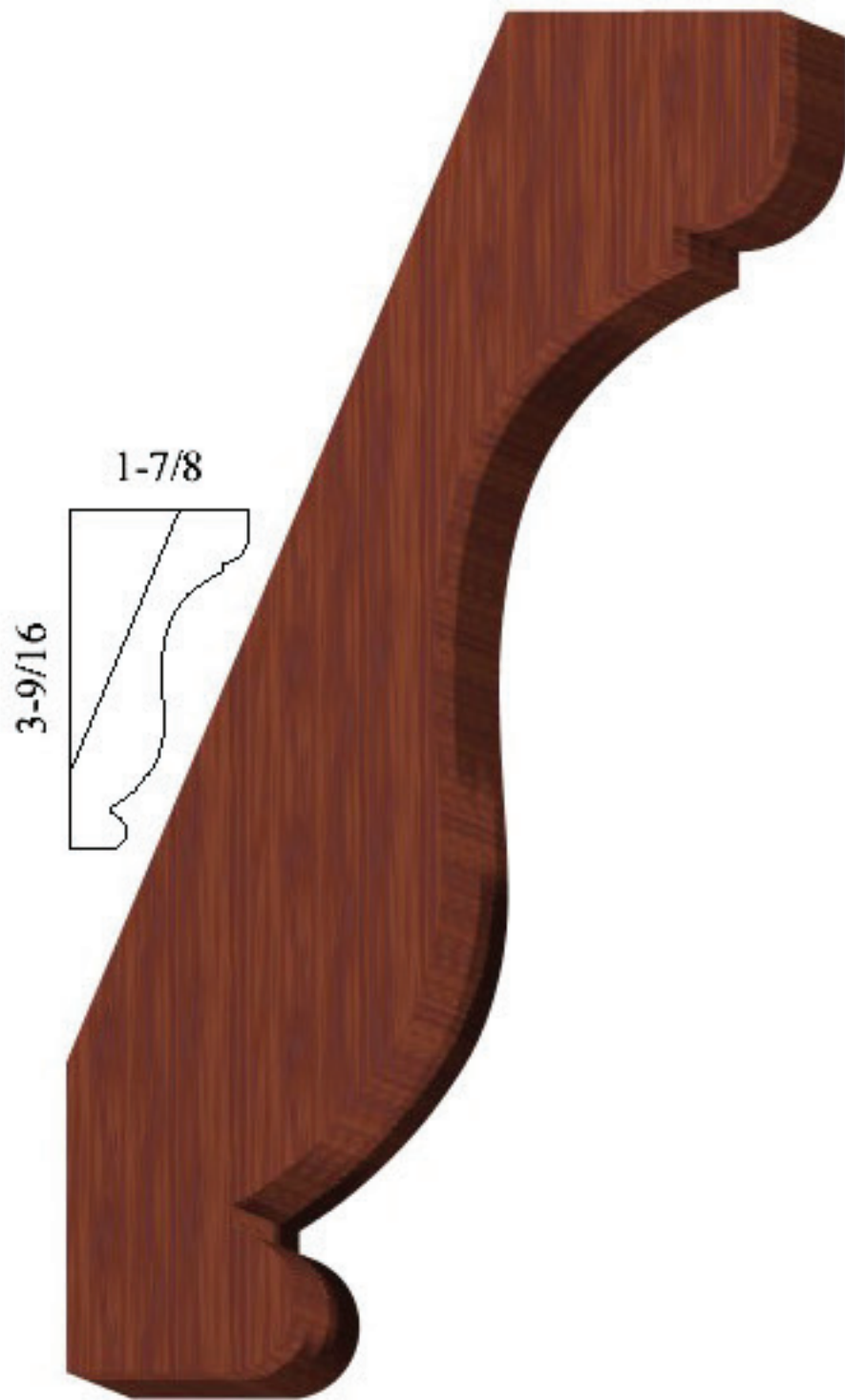

CR156
13/16 x 4

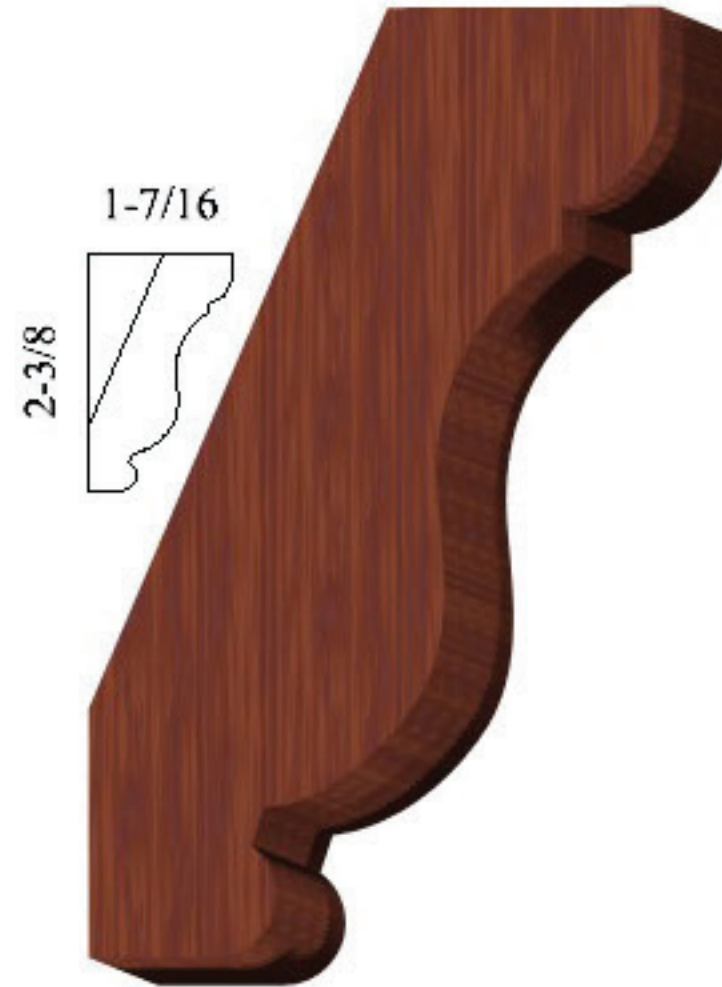

CR155
13/16 x 2-13/16

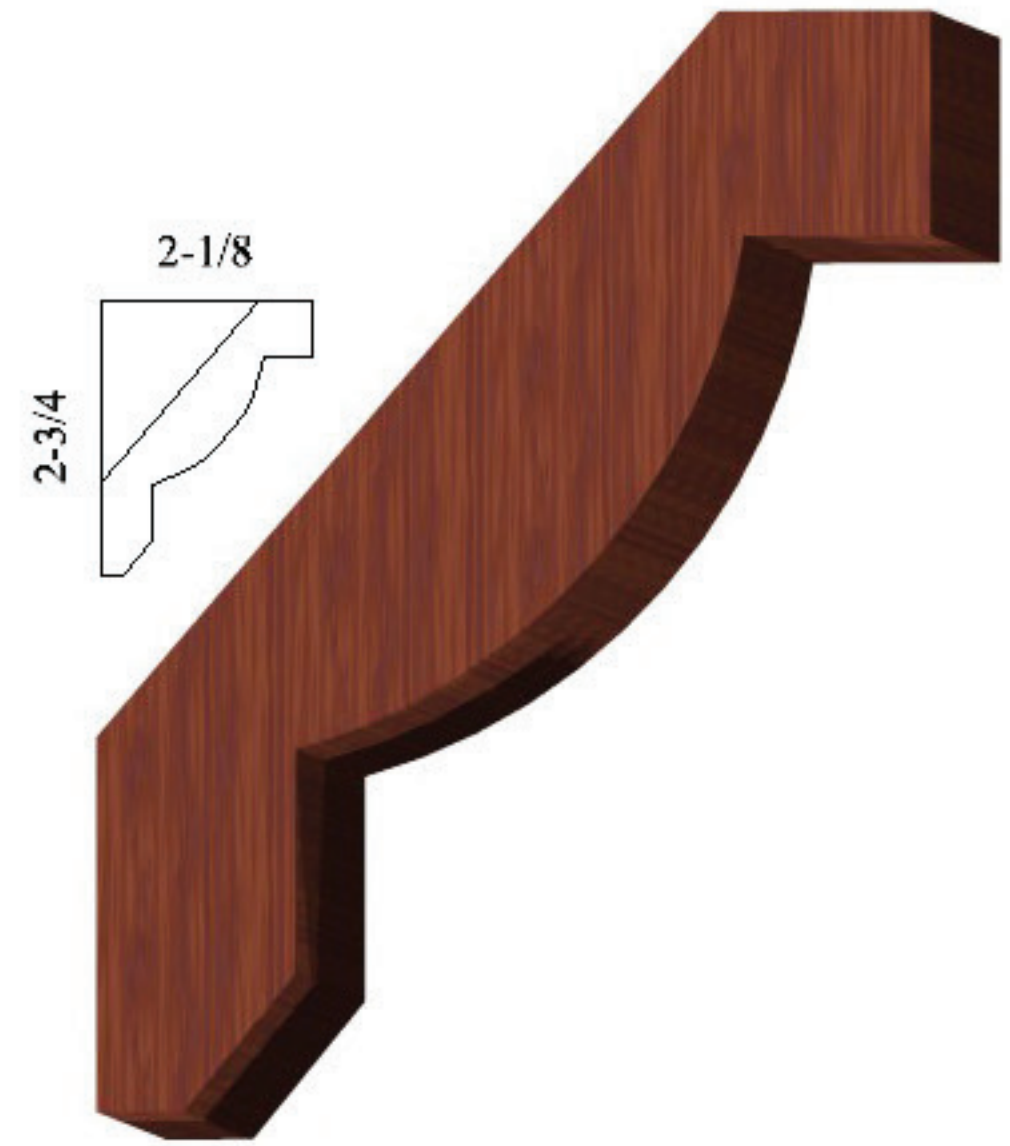

CR106
3/4 x 3-1/2

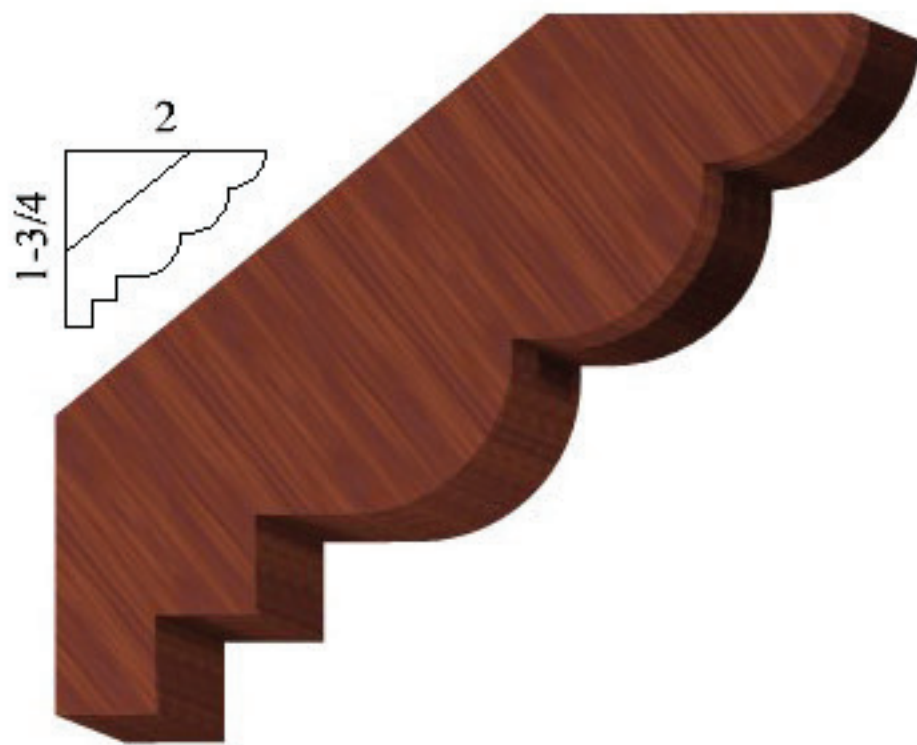

CR221
3/4 x 2-5/8

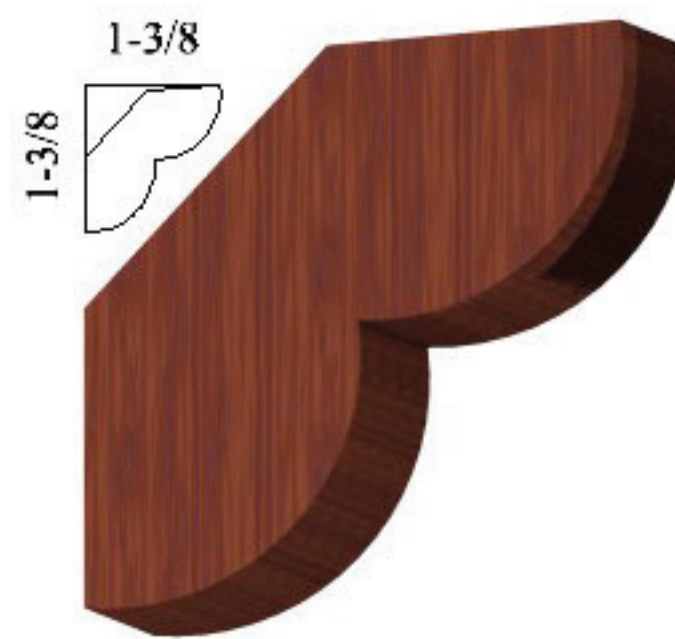

CR154
11/16 x 2

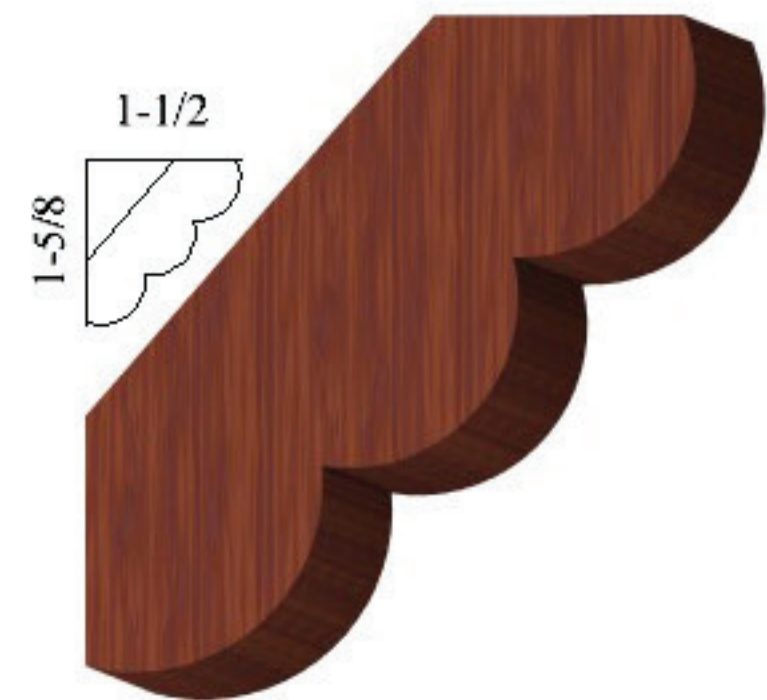

CR54
7/8 x 2-1/4

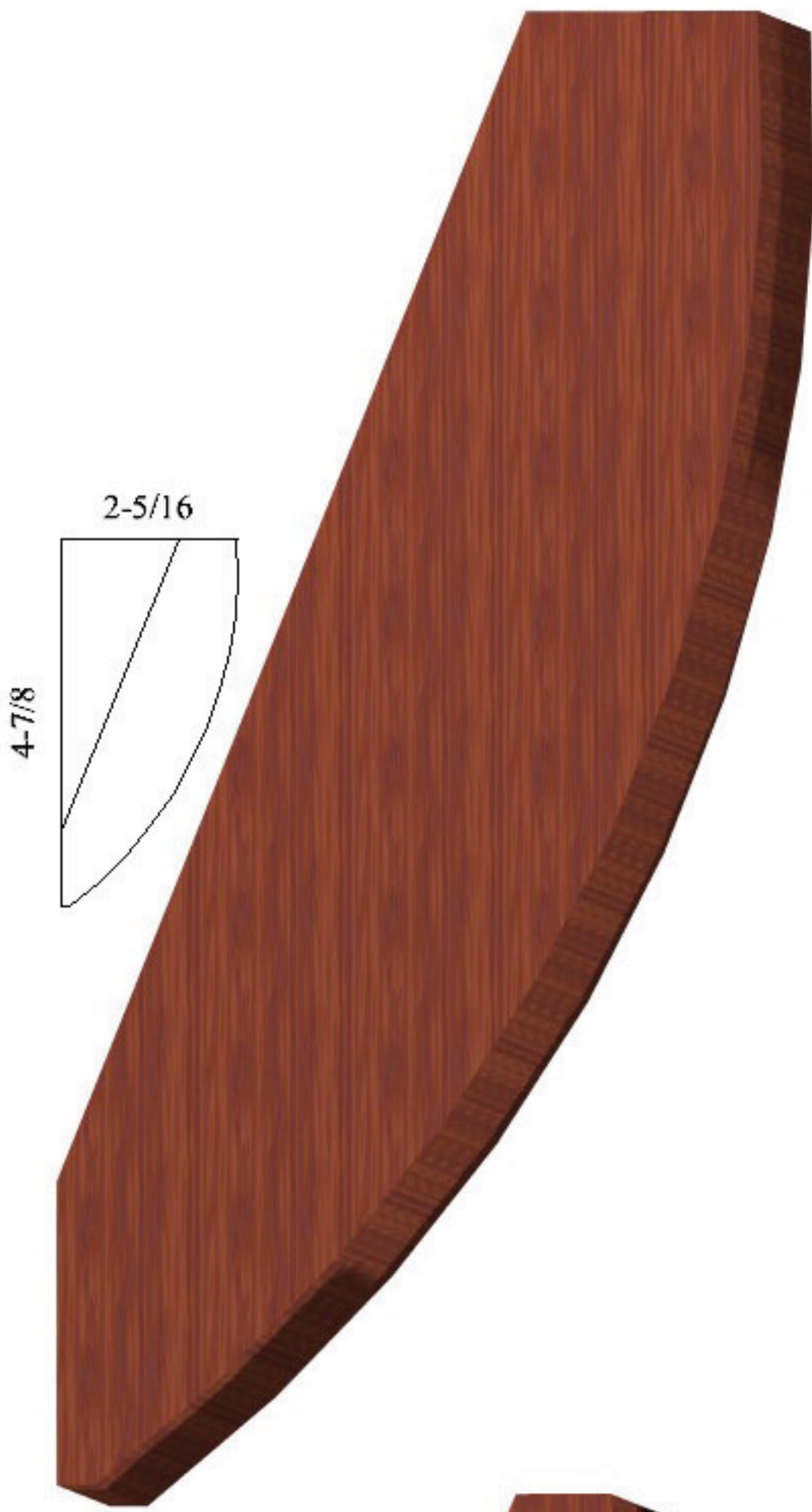

CR162
1-1/4 x 5-3/8



CR163
13/16 x 3-11/16

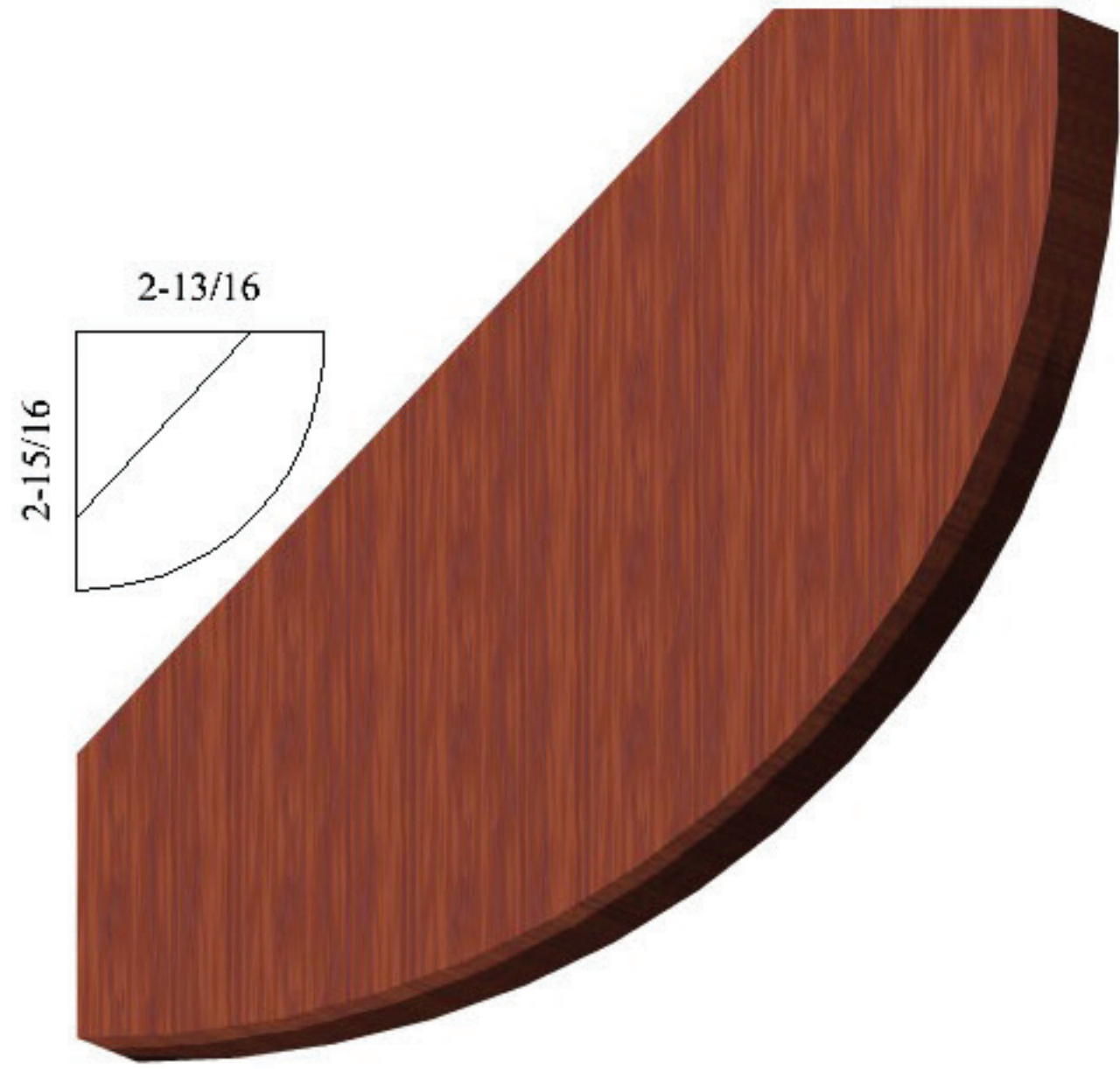

CR66
1-1/2 x 4-1/16

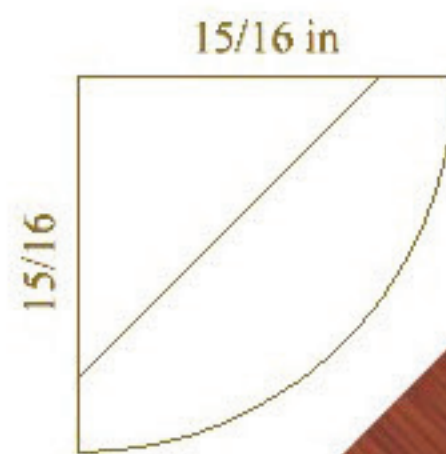

CR213
1-5/8 x 5-5/16

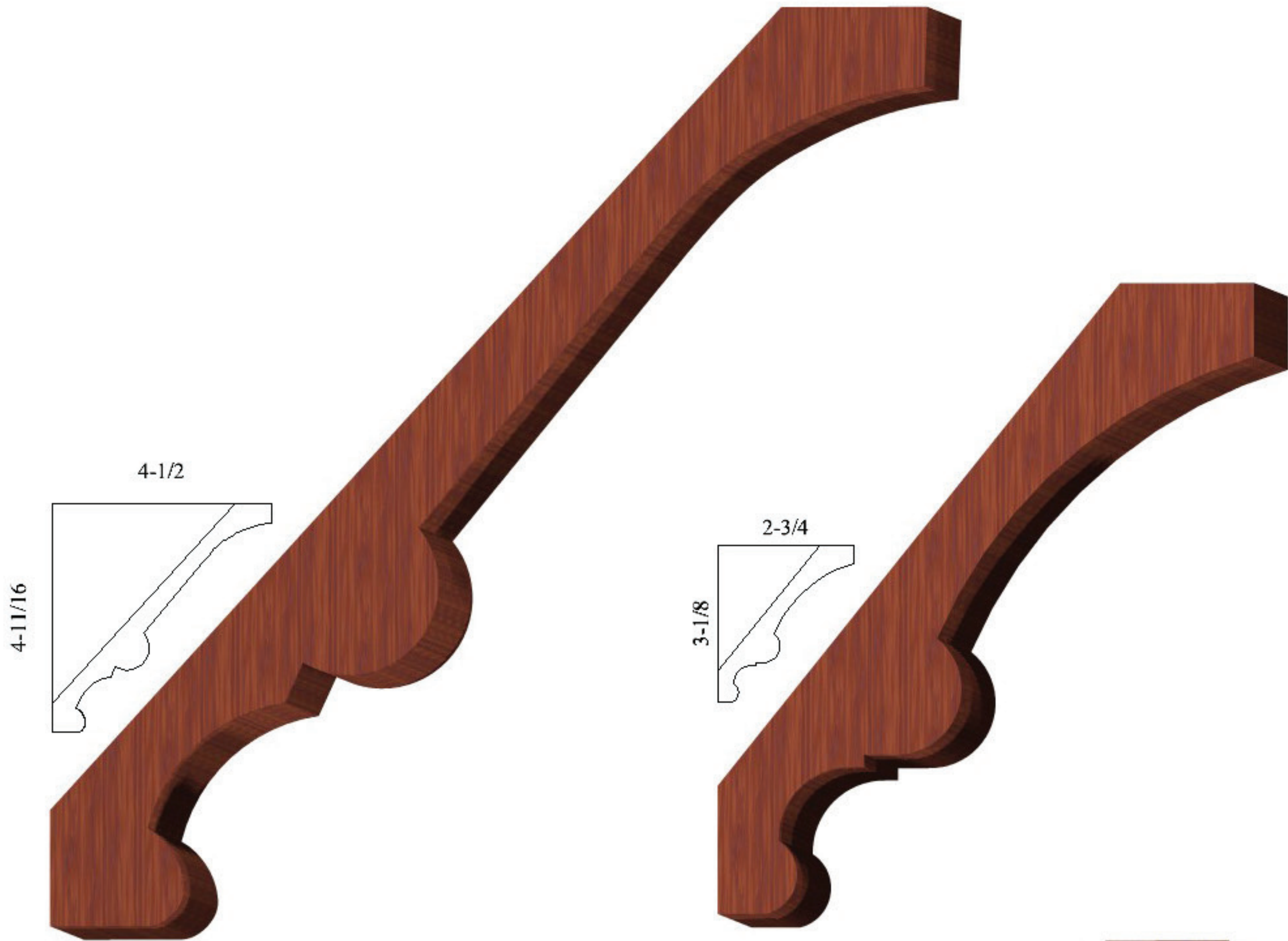

CR70
 $7/8 \times 6-1/2$

CR197
 $3/4 \times 4-1/4$

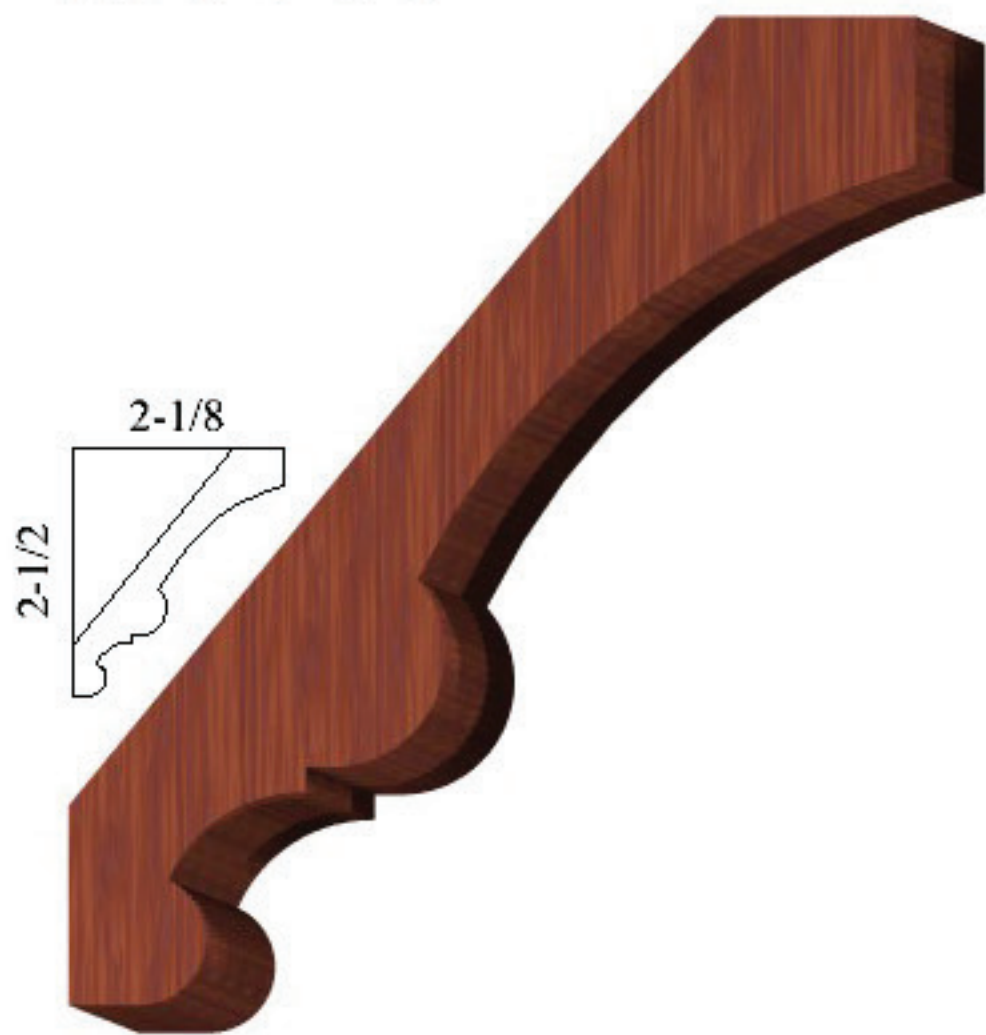

CR175
 $5/8 \times 3-1/4$

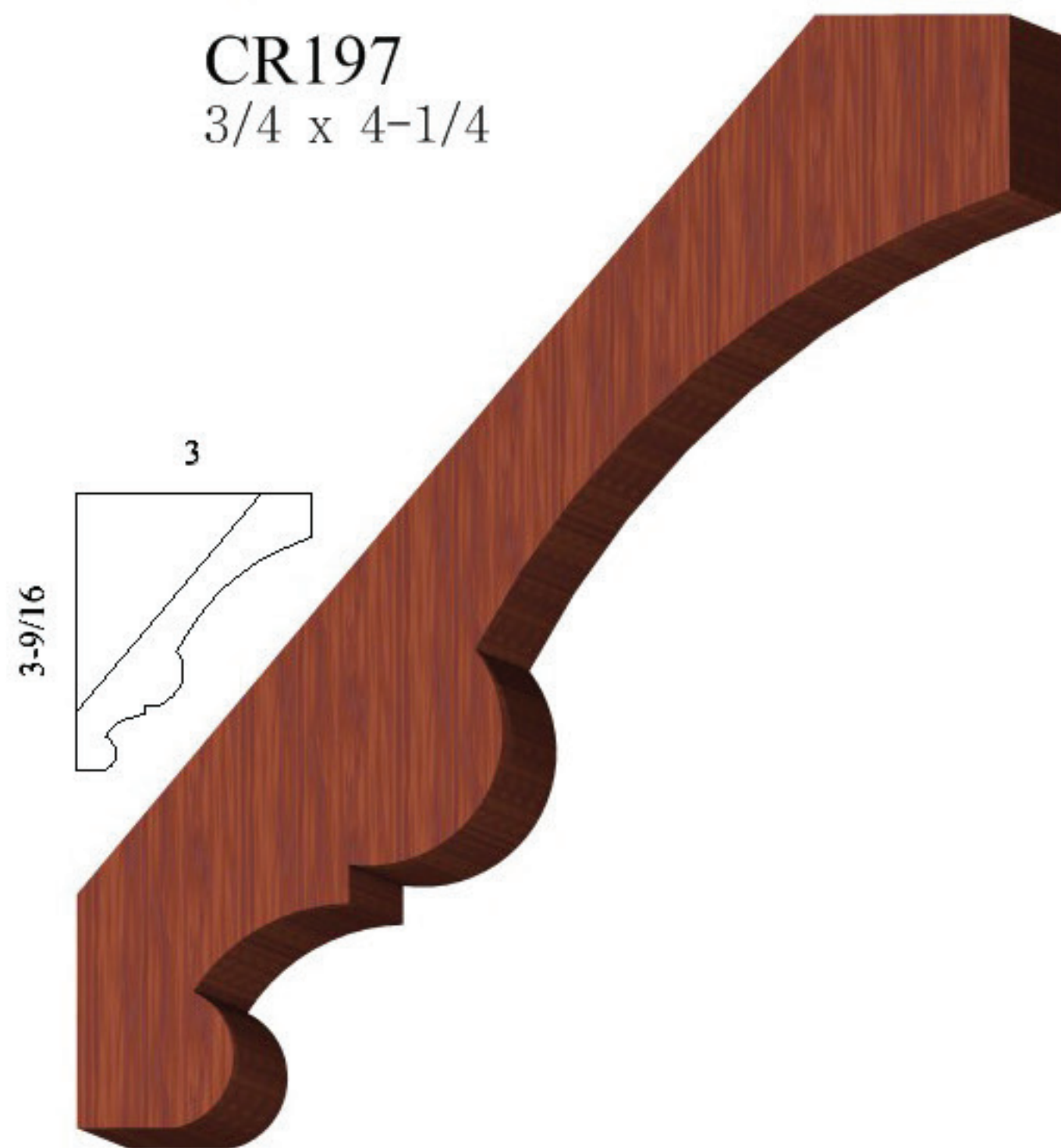

CR135
 $3/4 \times 4-11/16$

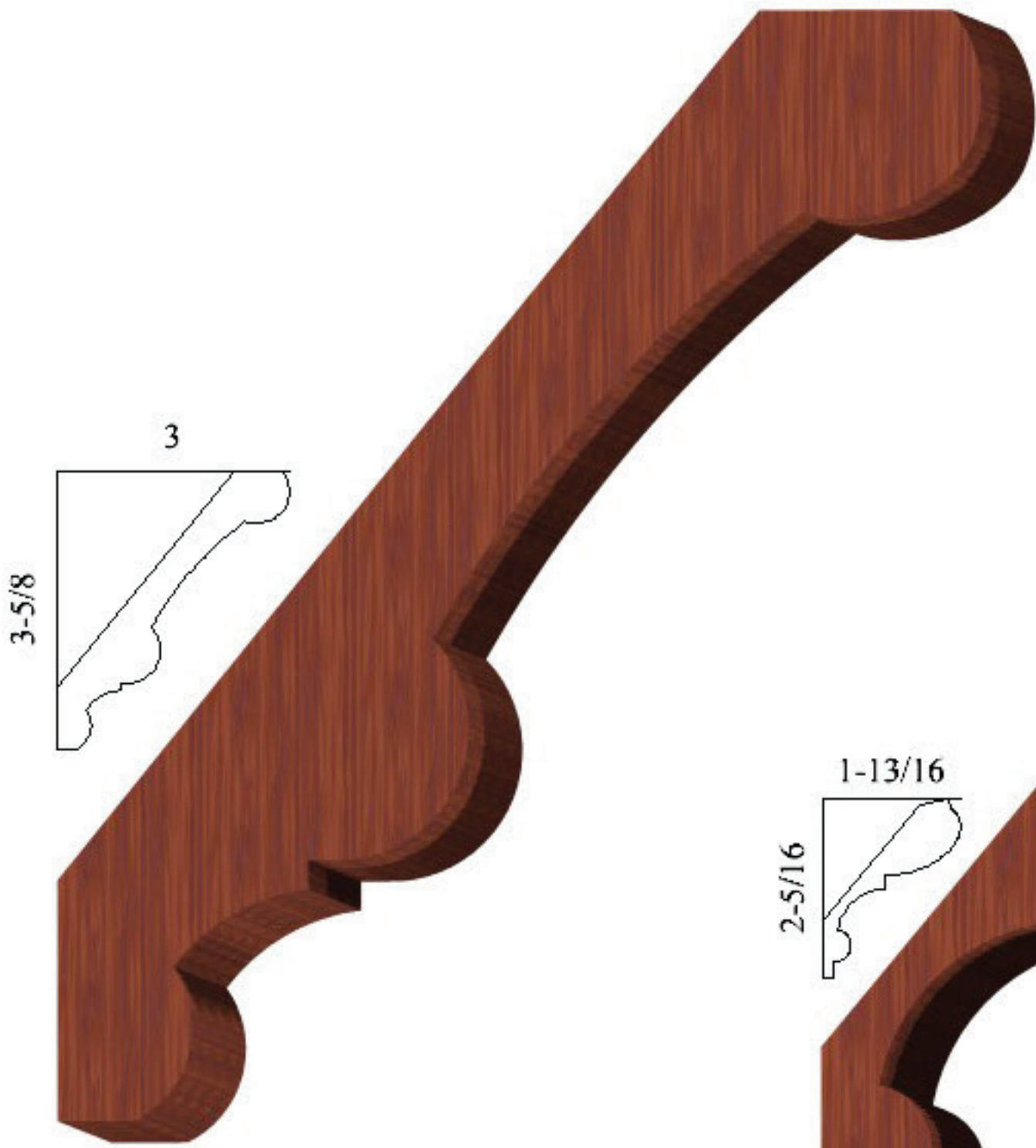

CR181
 $13/16 \times 4-5/8$

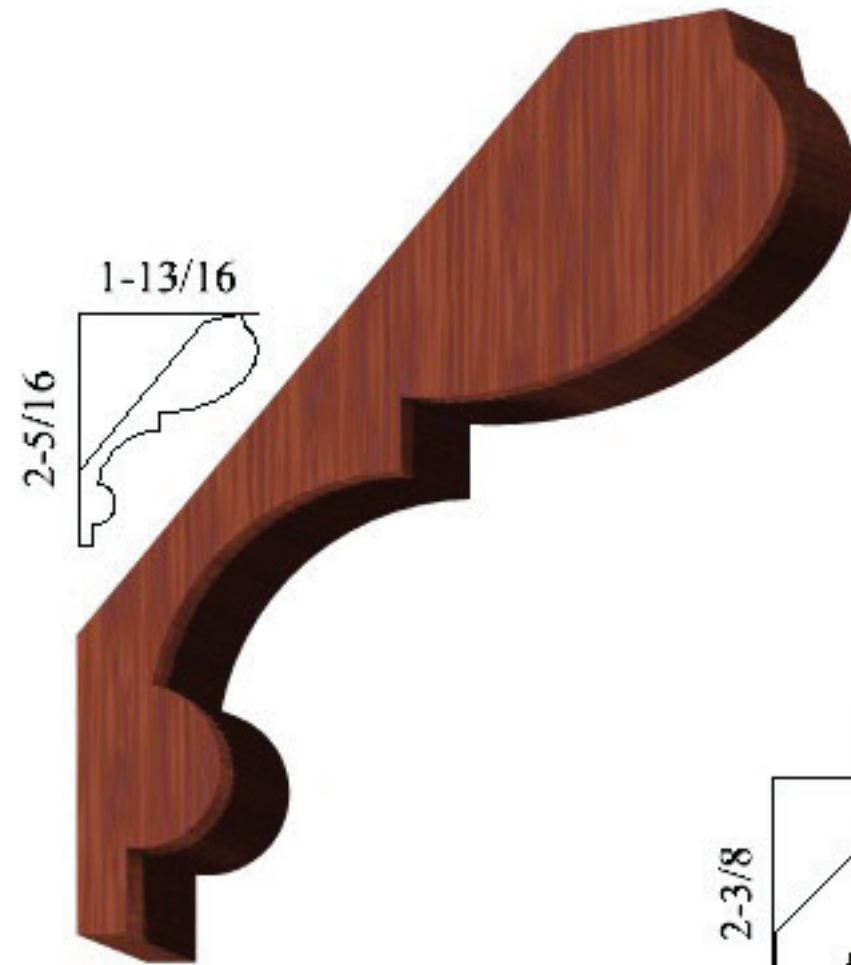

CR146
 $5/8 \times 2-7/8$



CR229
 $13/16 \times 3-1/2$

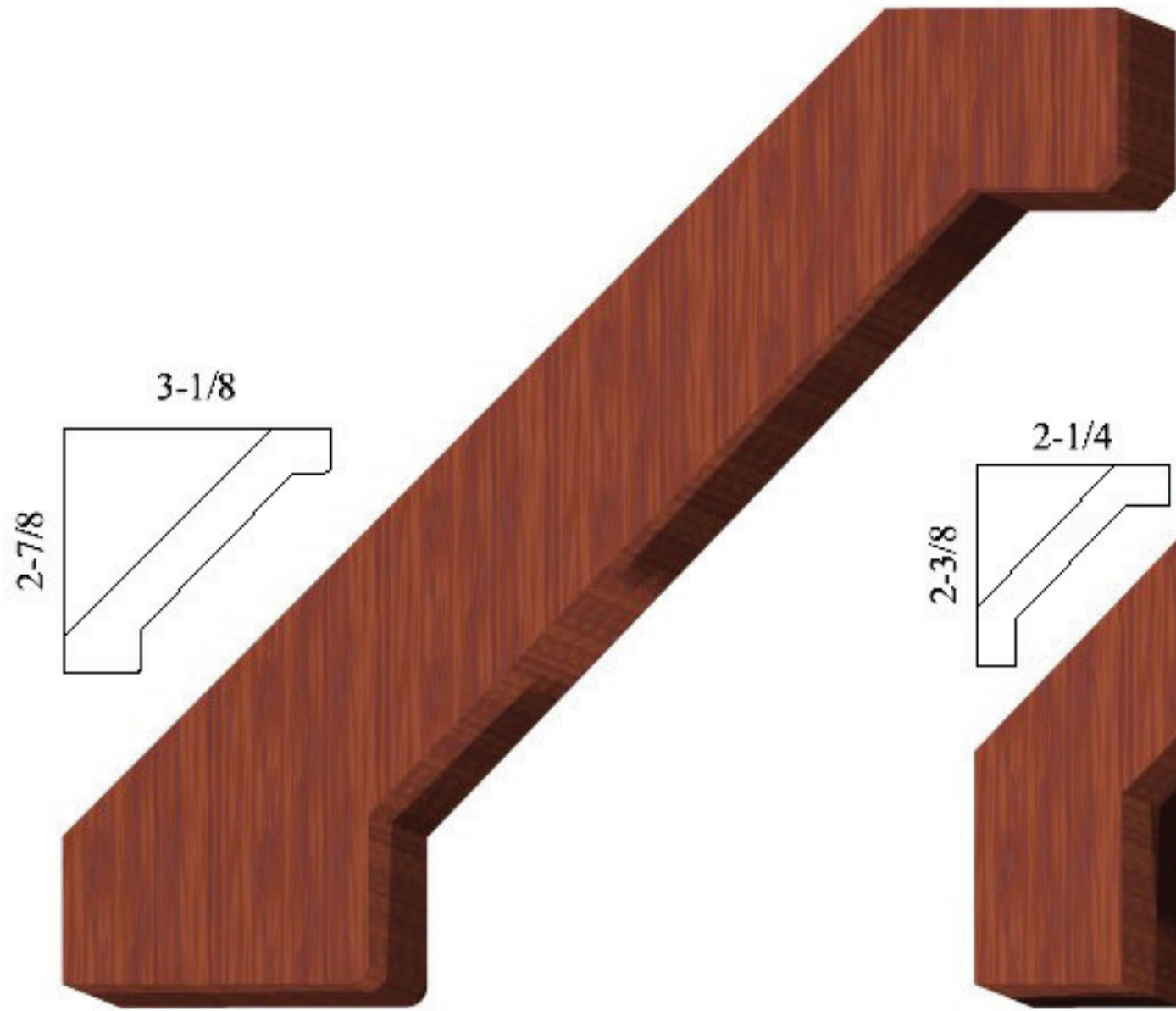

CR08
7/8 x 4-1/4

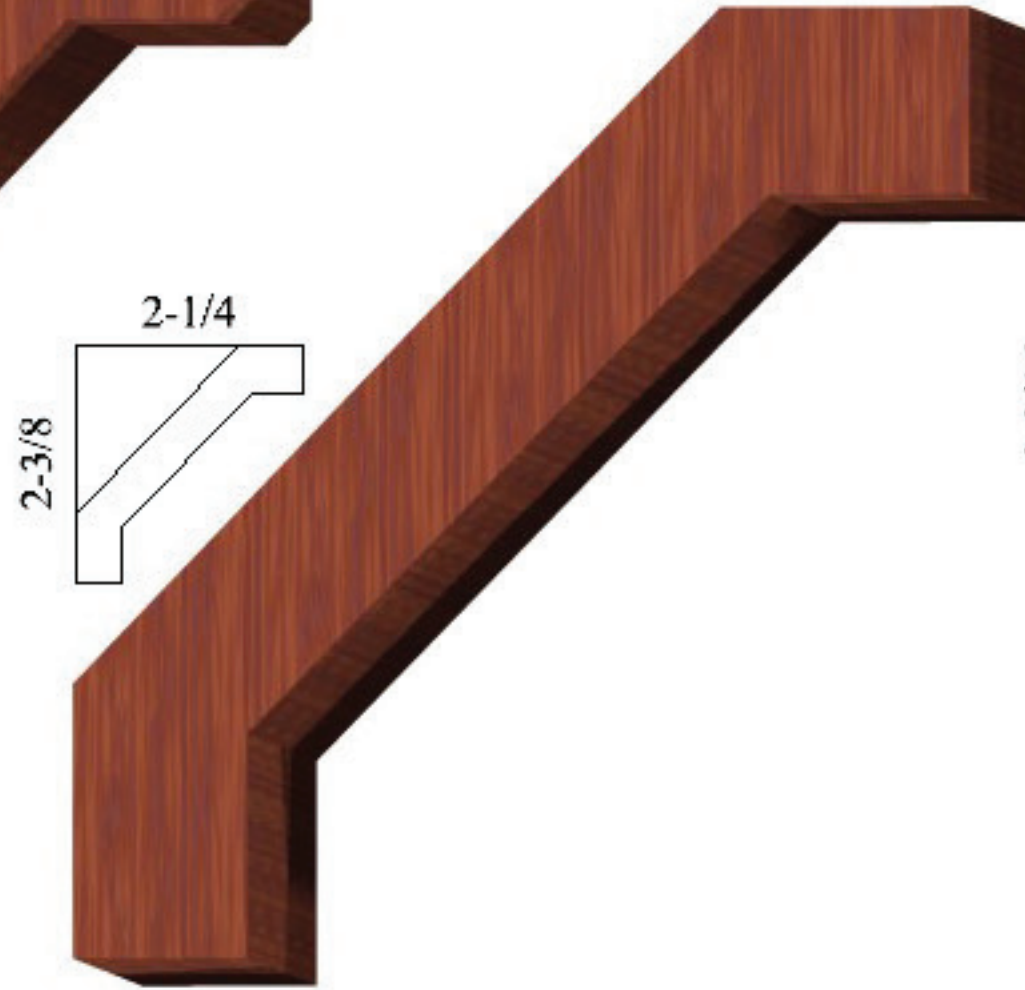

CR02
3/4 x 3-5/16

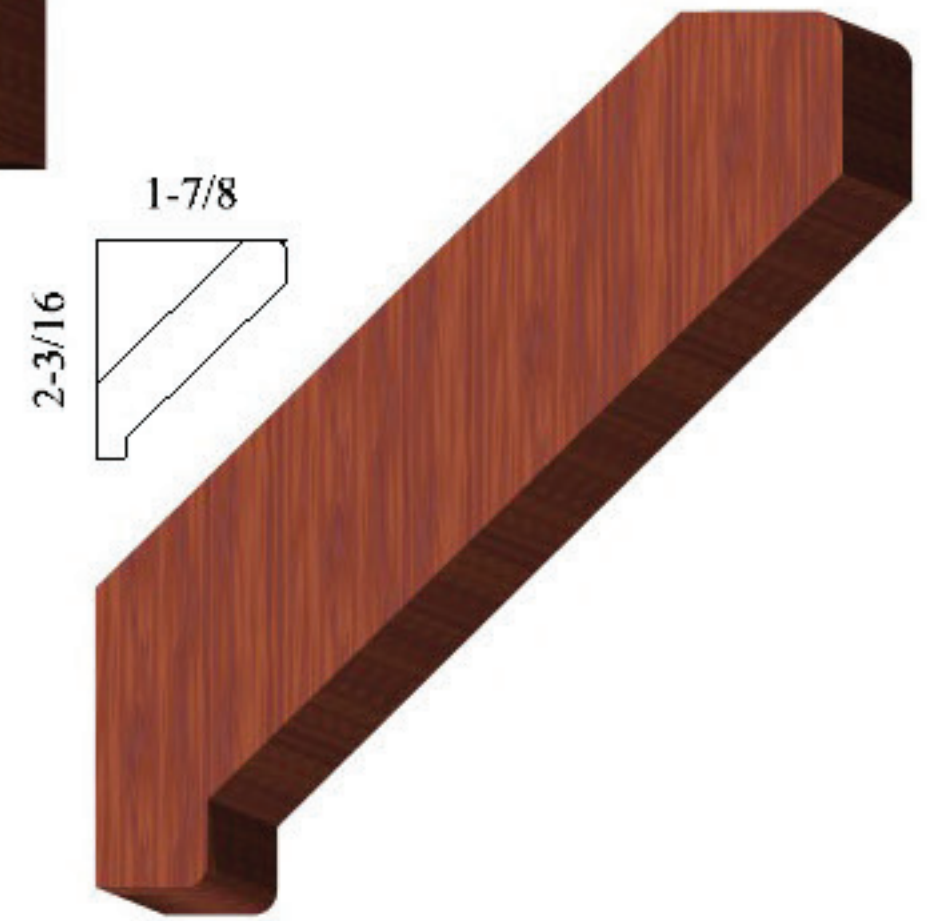

CR125
11/16 x 2-7/8

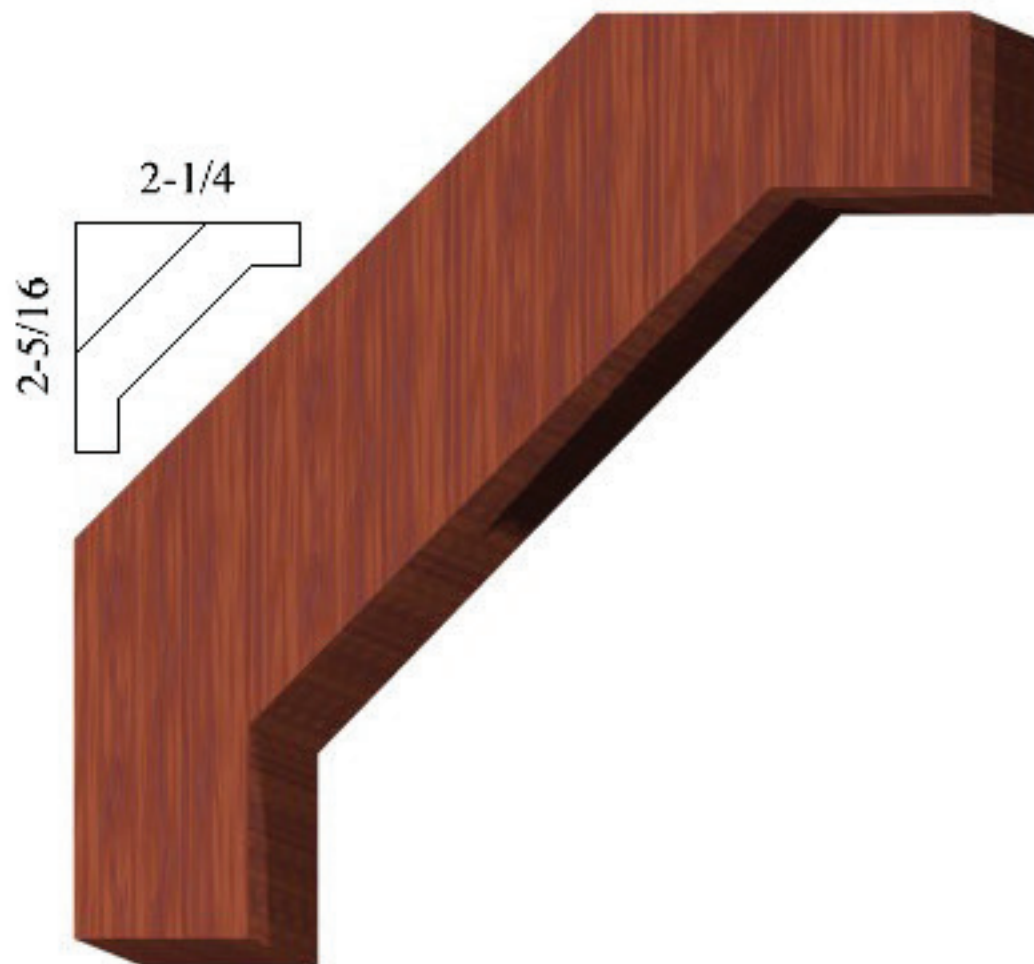

CR149
5/8 x 3-1/4

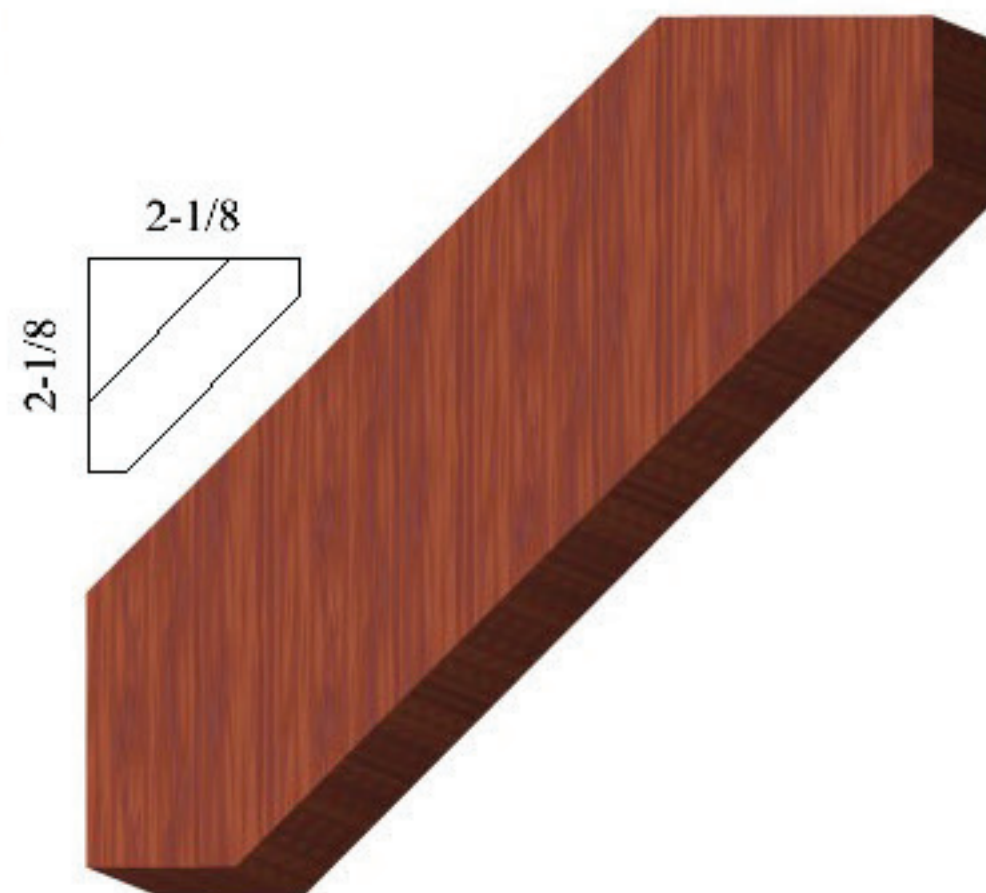

CR203
3/4 x 3

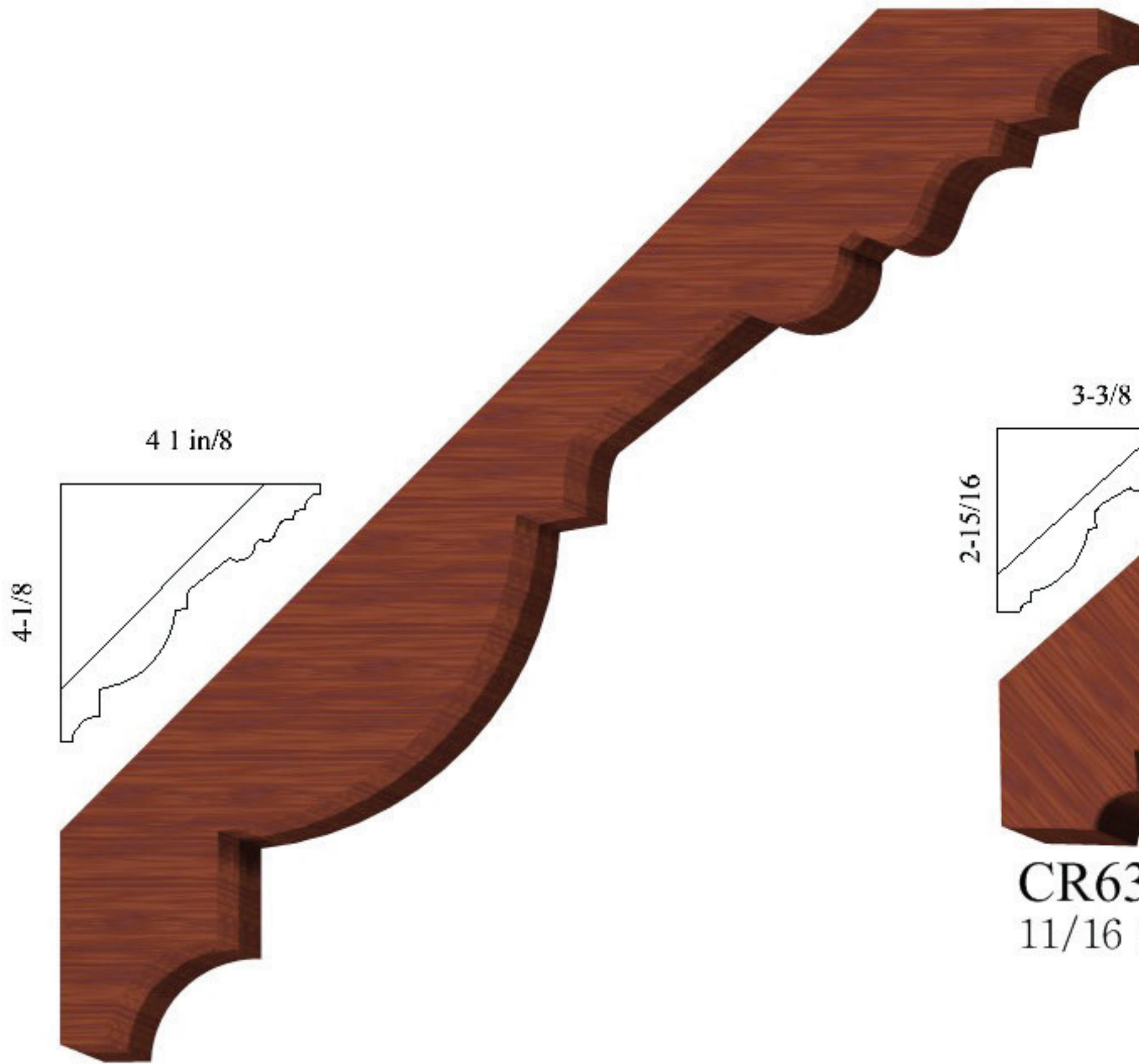

CR36
 $\frac{7}{8} \times 5\frac{13}{16}$

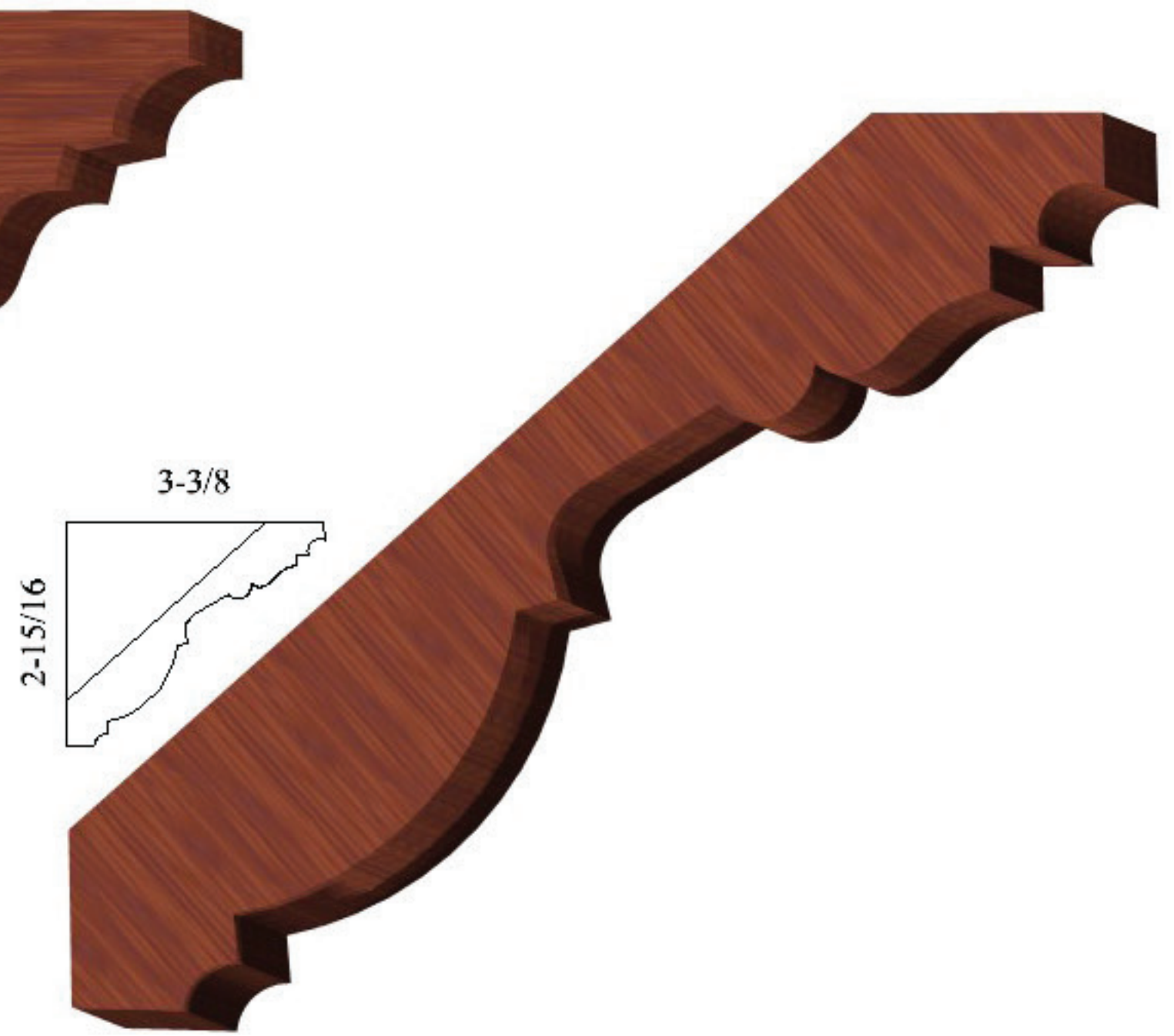

CR63
 $\frac{11}{16} \times 4\frac{1}{2}$

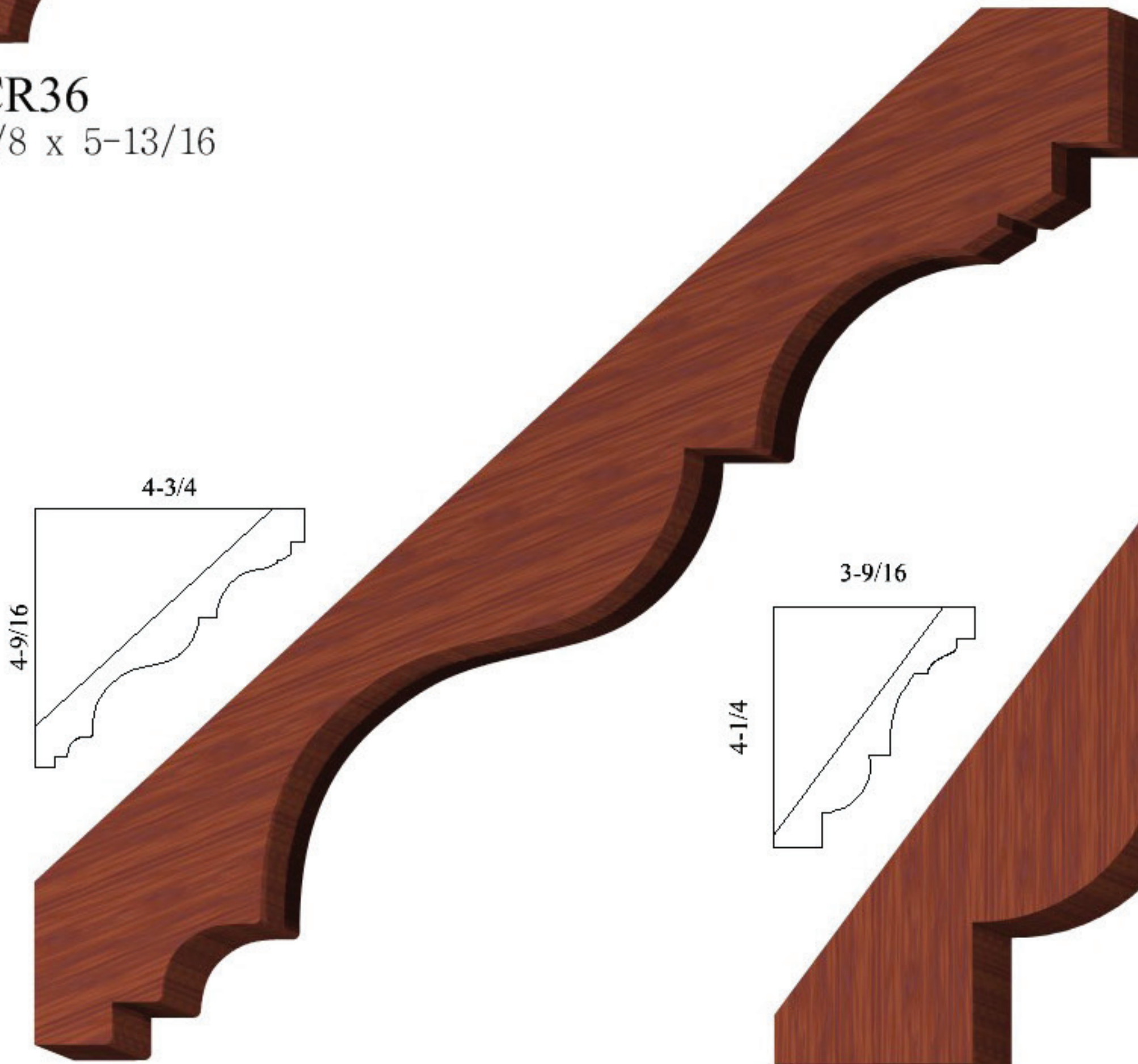

CR79
 $\frac{3}{4} \times 6\frac{1}{2}$

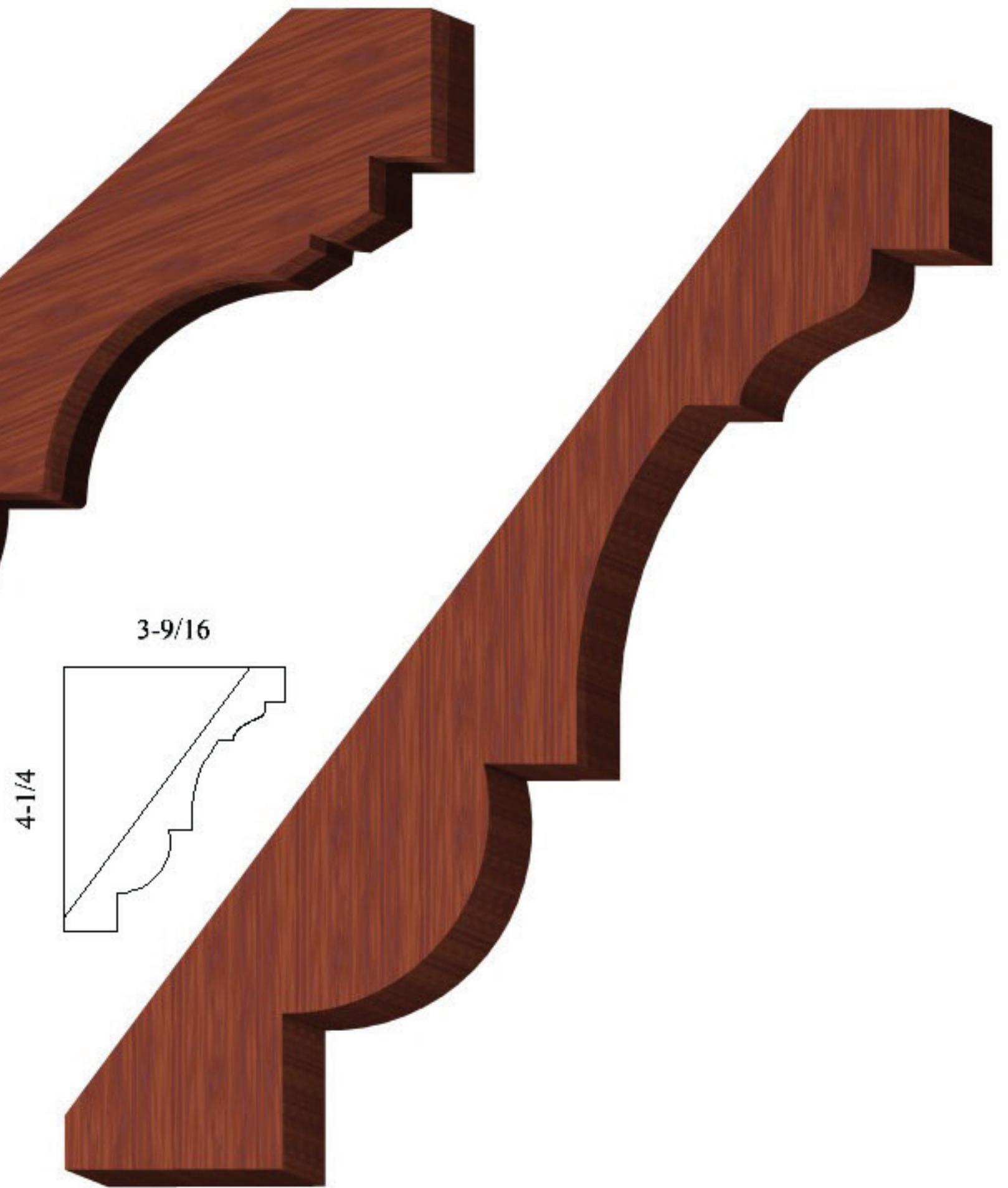

CR38
 $\frac{3}{4} \times 5\frac{9}{16}$

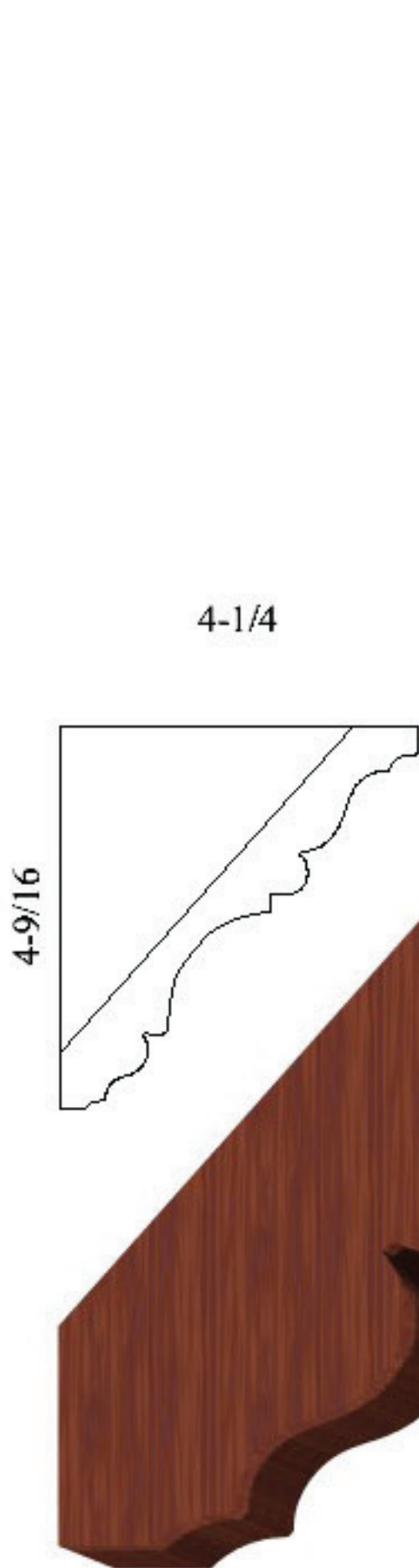

CR72
13/16 x 6-1/4

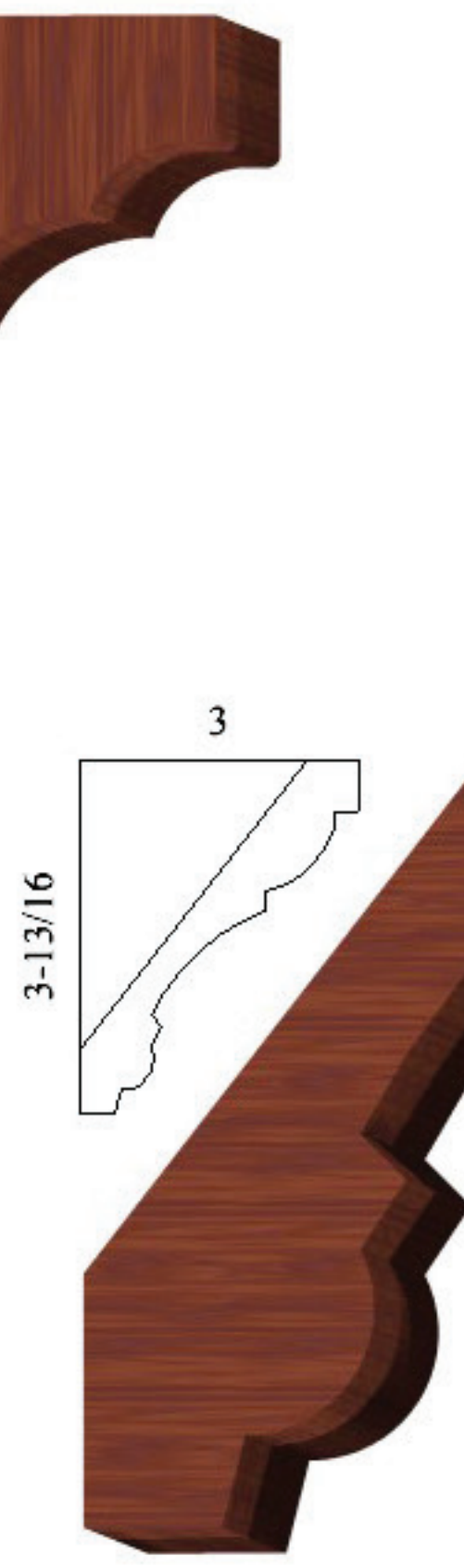

CR94
3/4 x 4-7/8

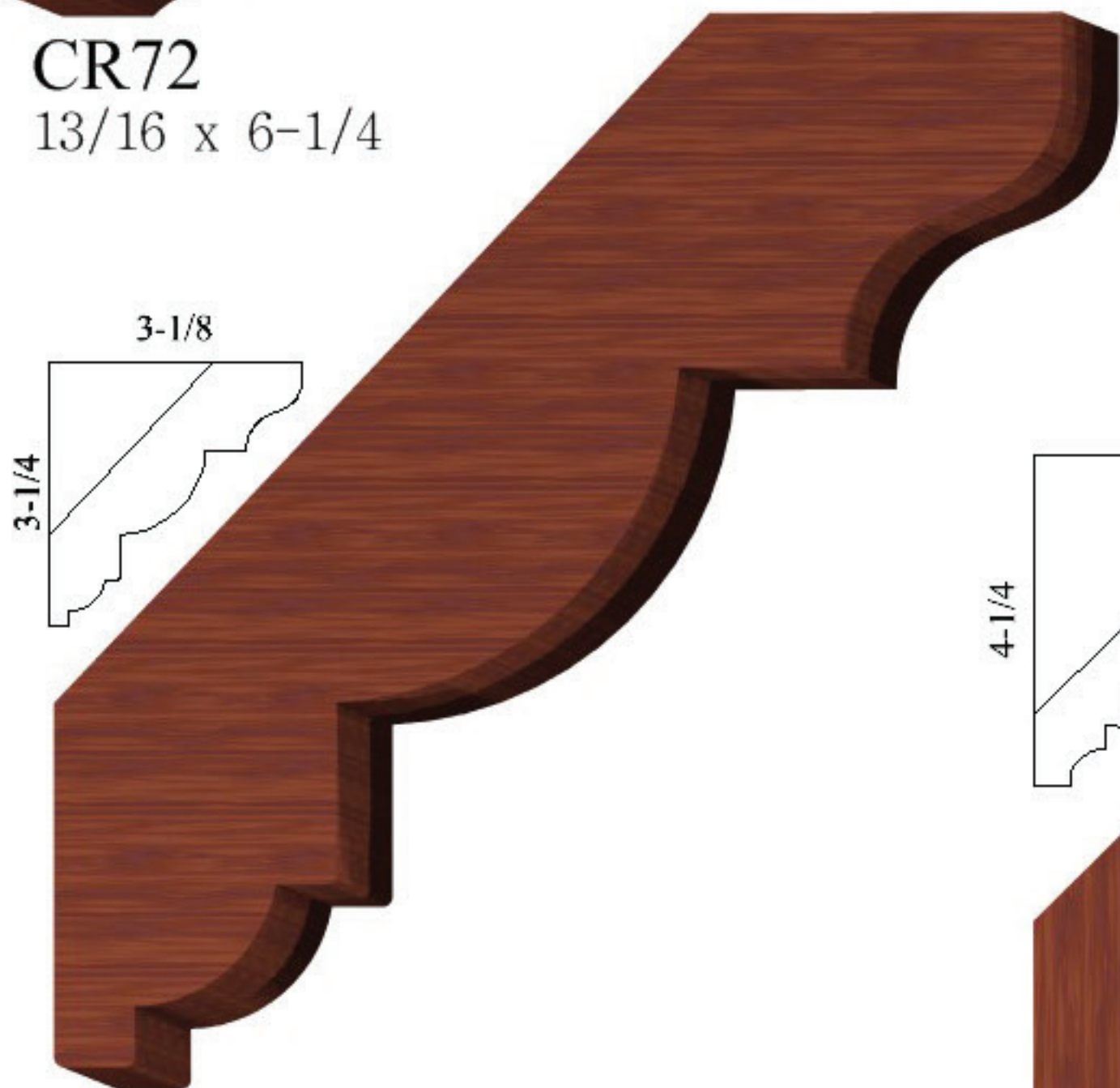

CR131
1/4 x 4-1/4



CR195
15/16 x 5-3/4

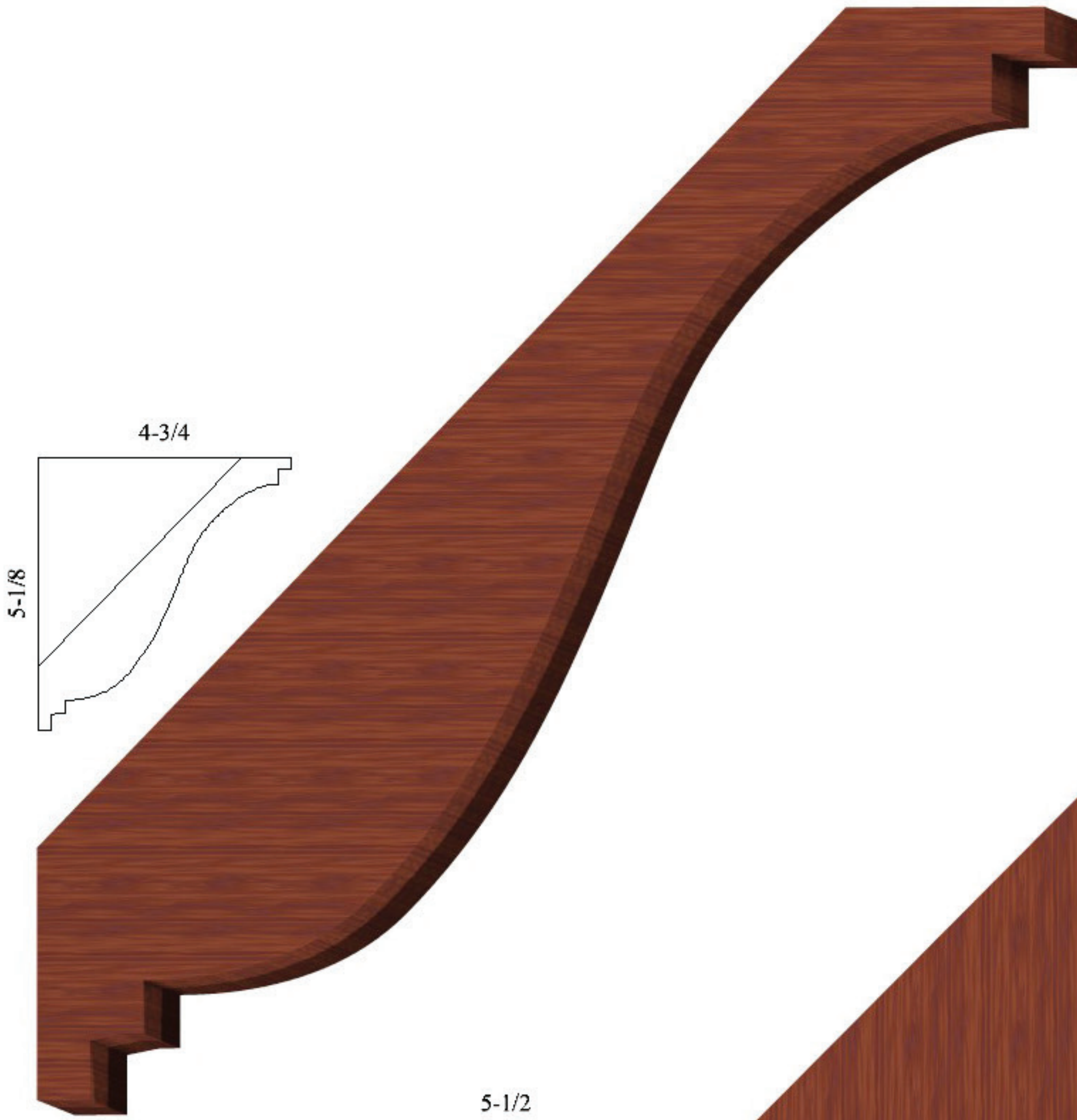

CR101
1-3/8 x 7



CR100
1-1/4 x 7-5/8

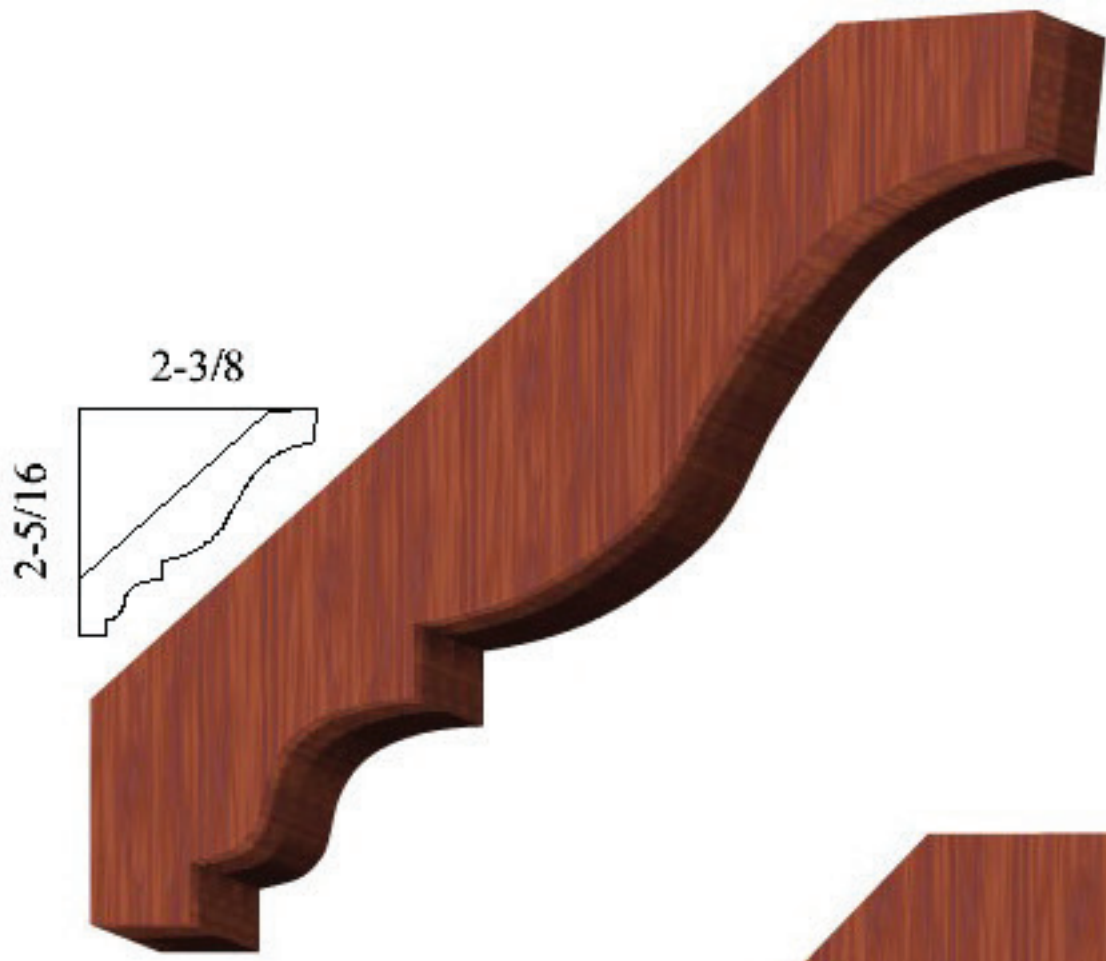

CR12
5/8 x 3-5/16

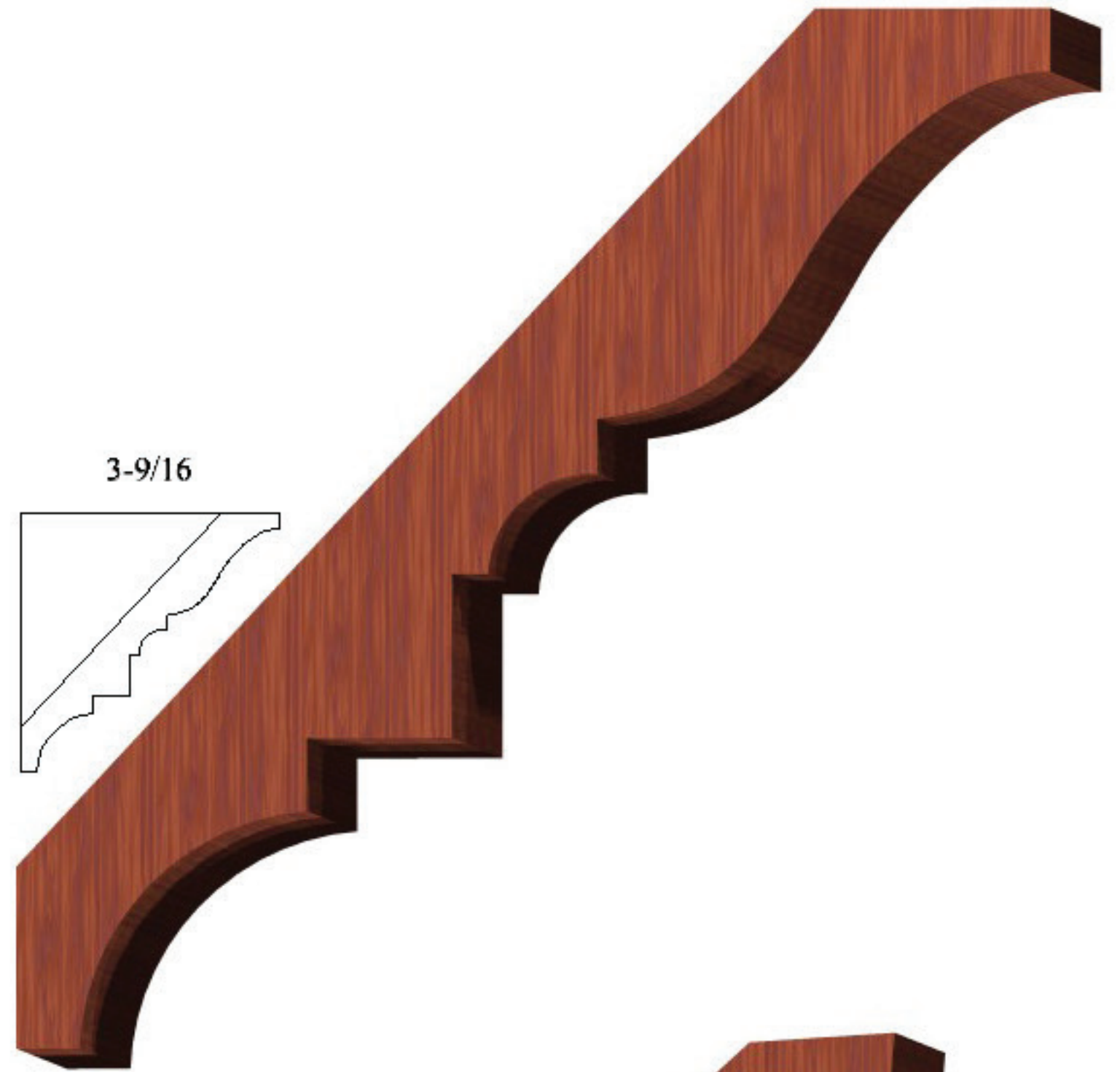

CR39
5/8 x 5-1/16



CR89
3-1/16 x 4-3/16

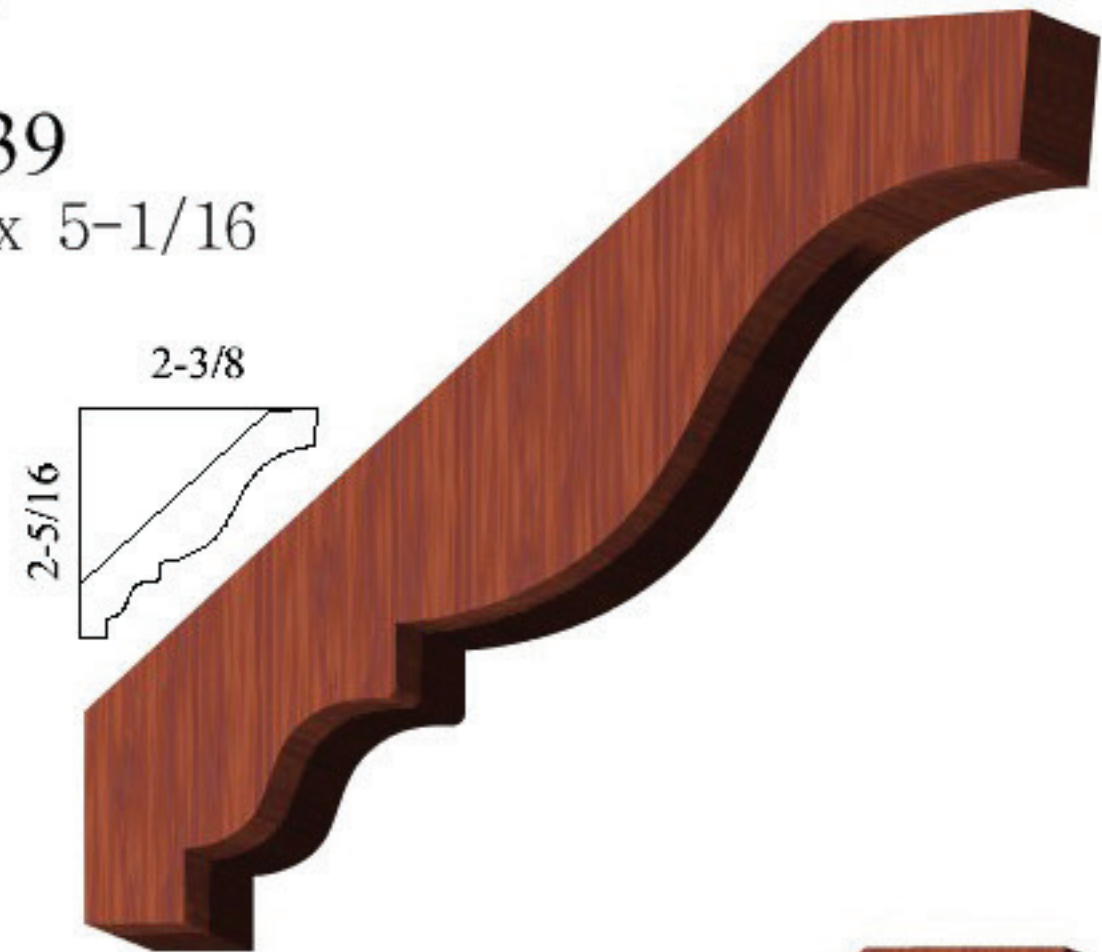

CR113
9/16 x 3-5/16

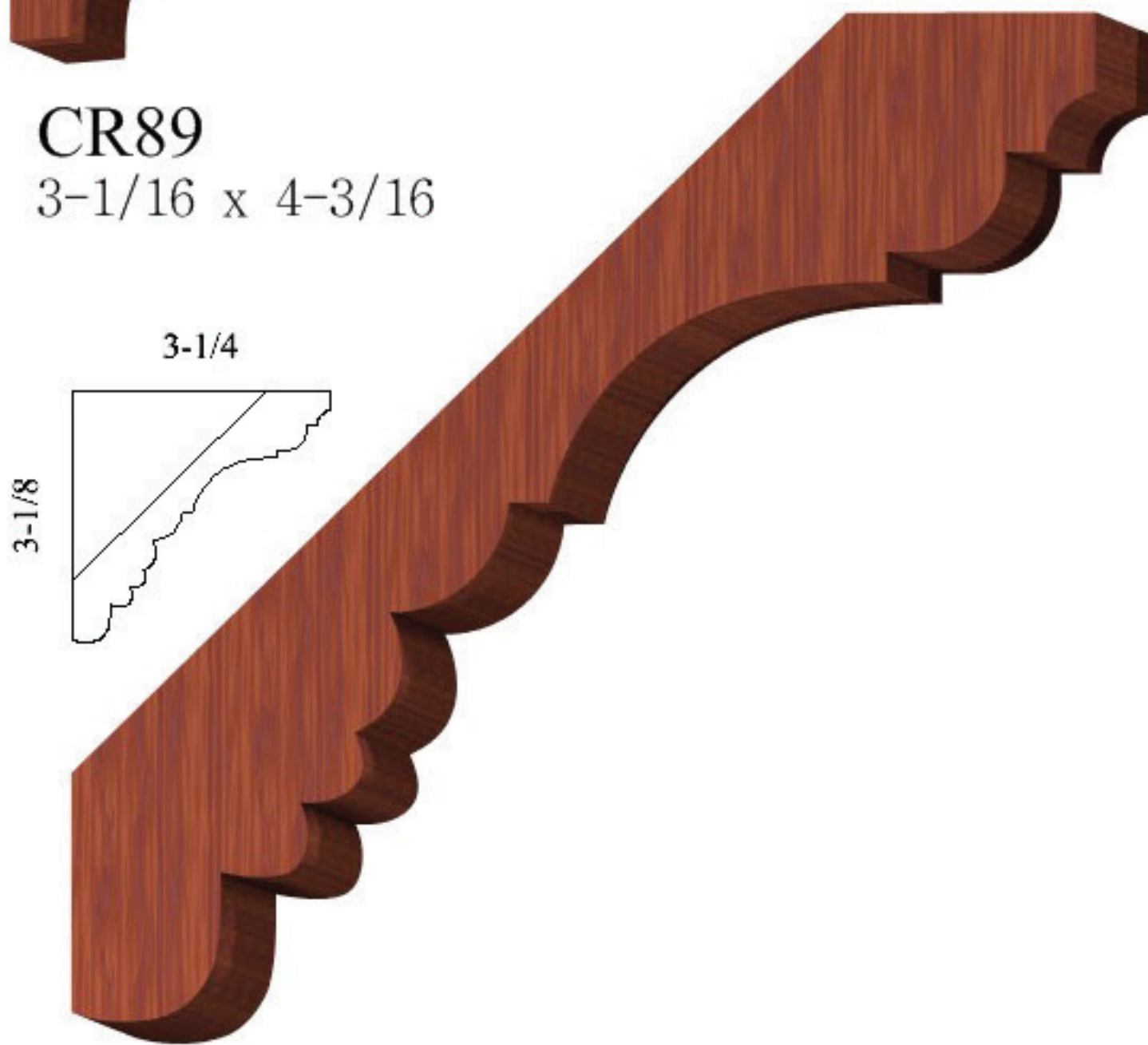

CR01
3/4 x 4-1/2

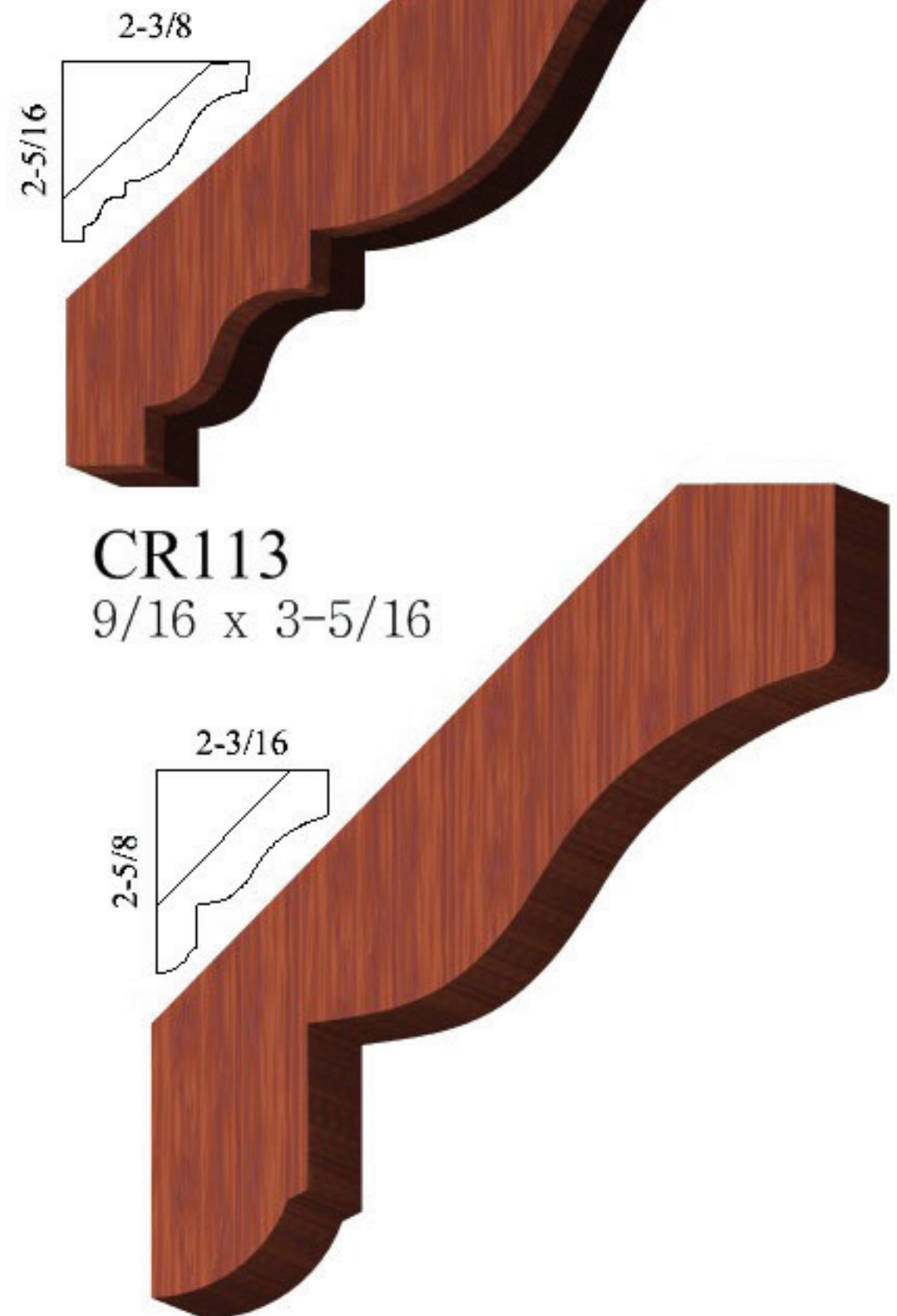

CR188
5/8 x 3-13/16

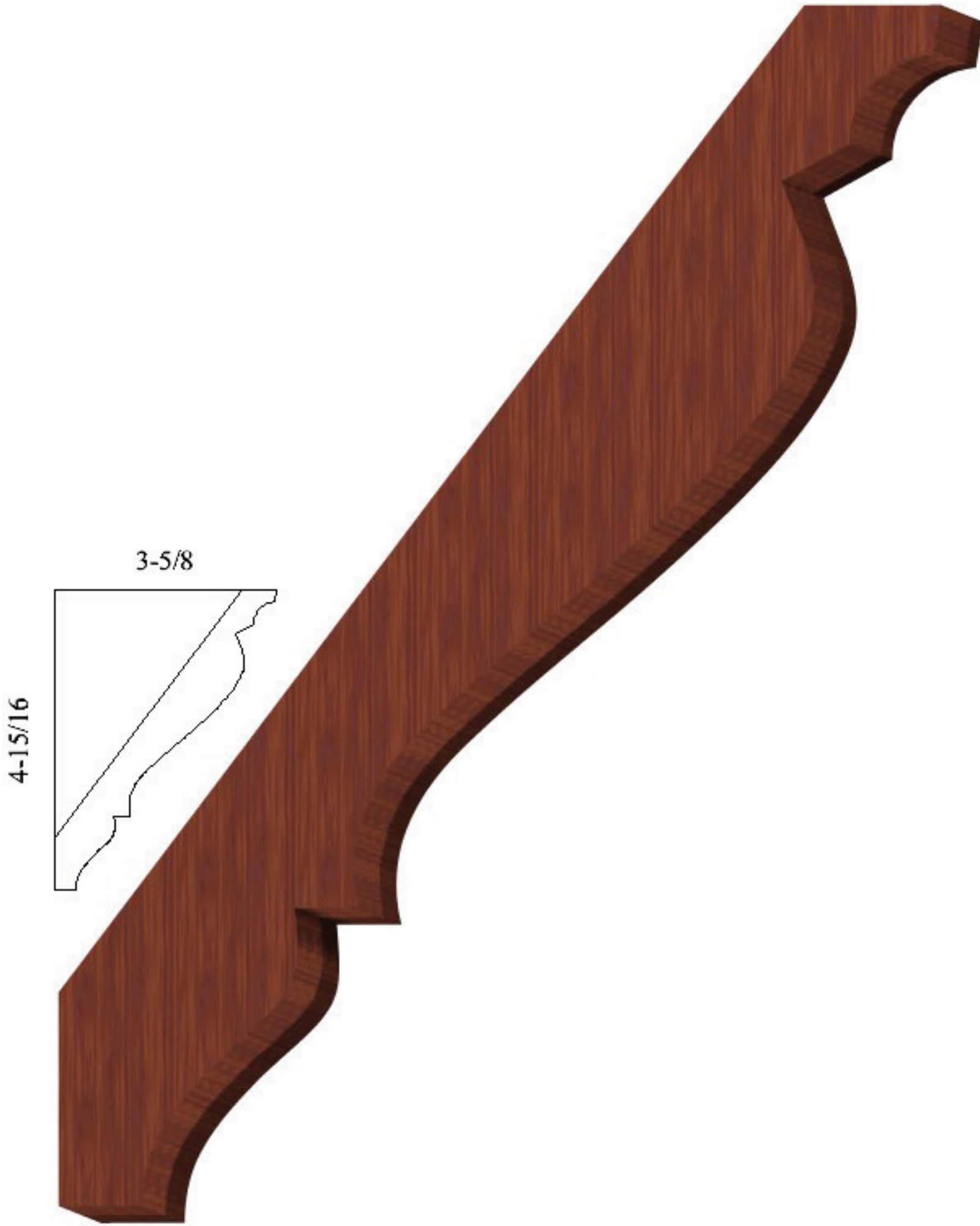

CR170
 $7/8 \times 6-1/8$

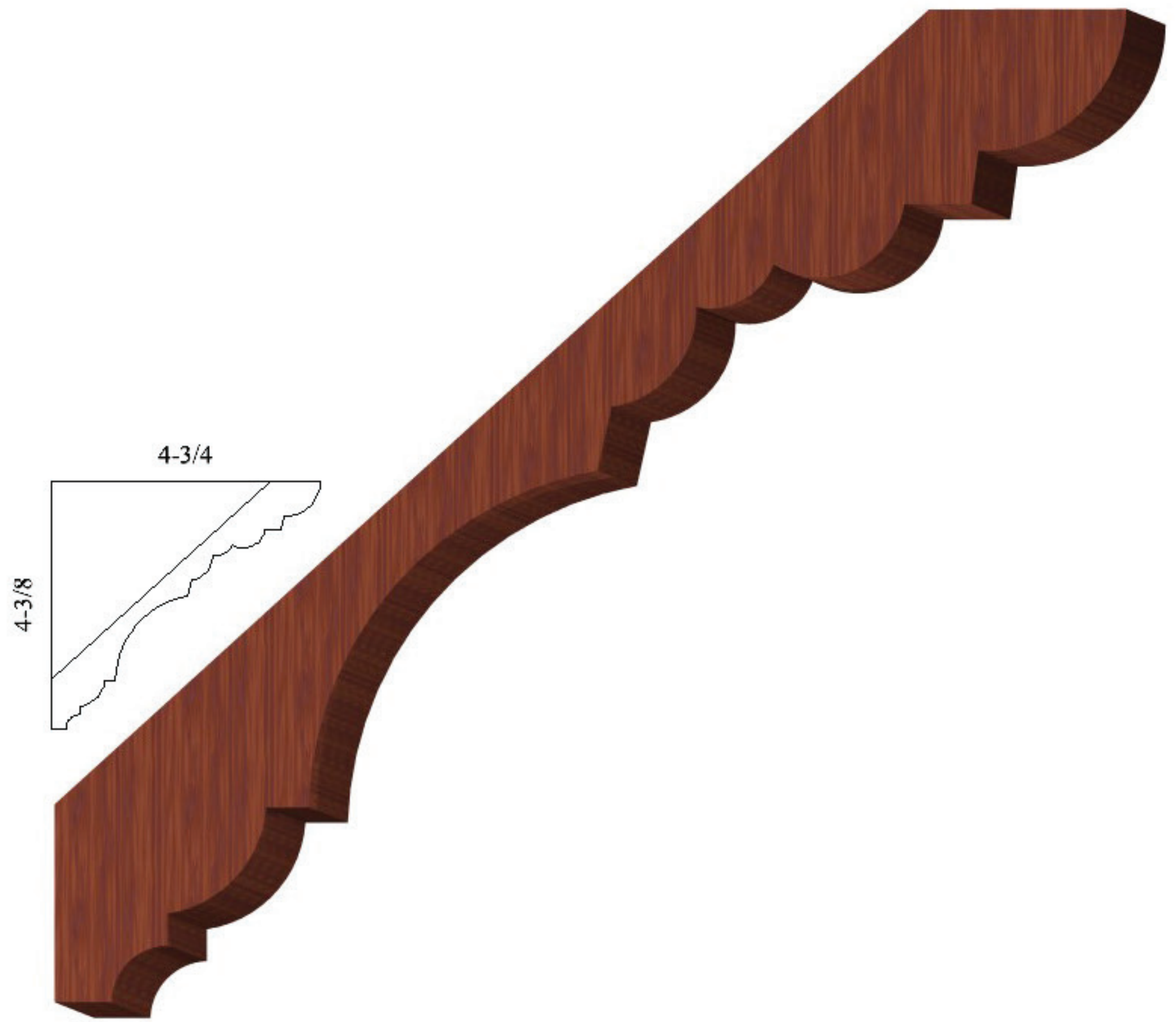

CR78
 $3/4 \times 6-1/2$

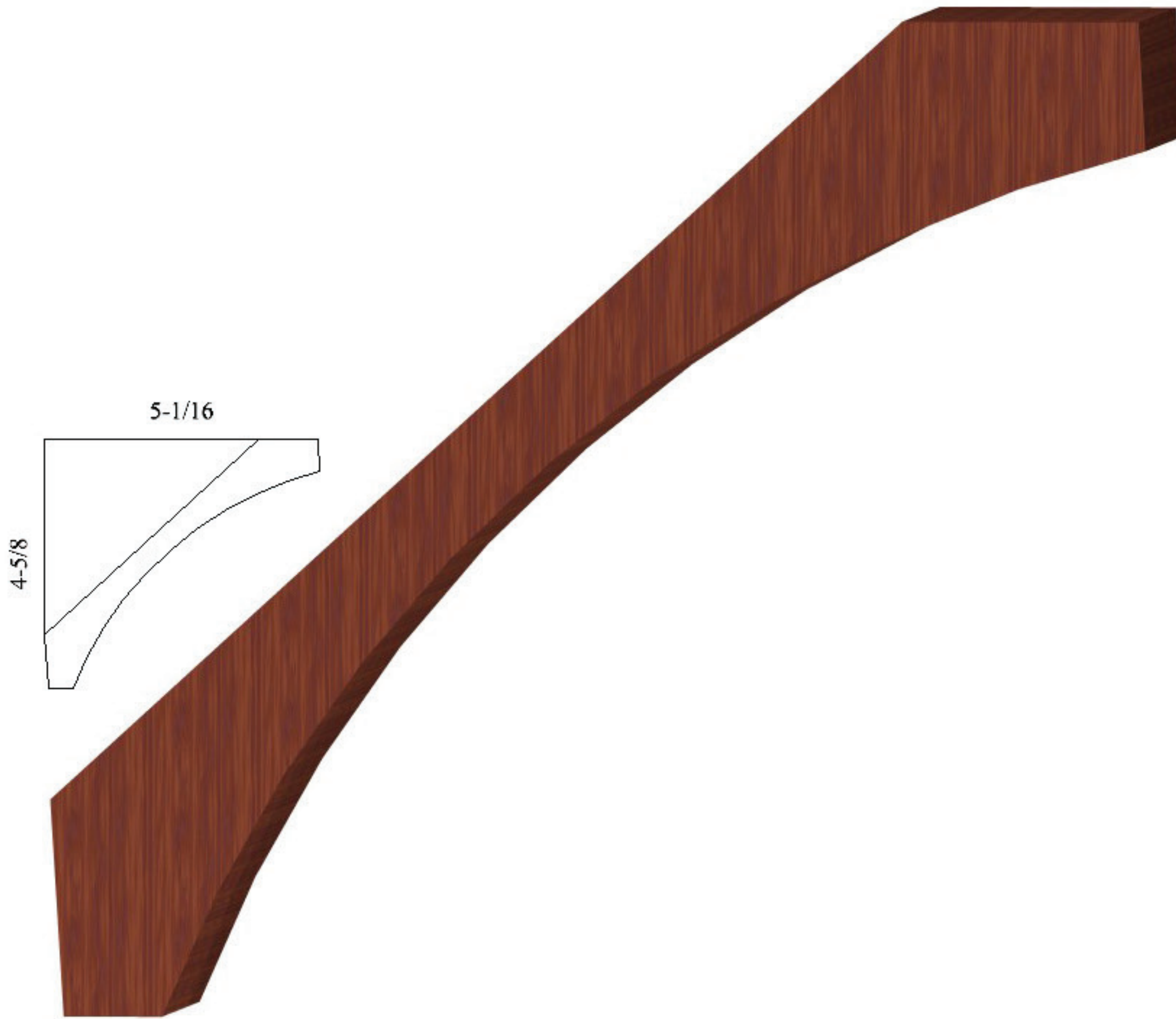

CR186
1-1/4 x 6-13/16

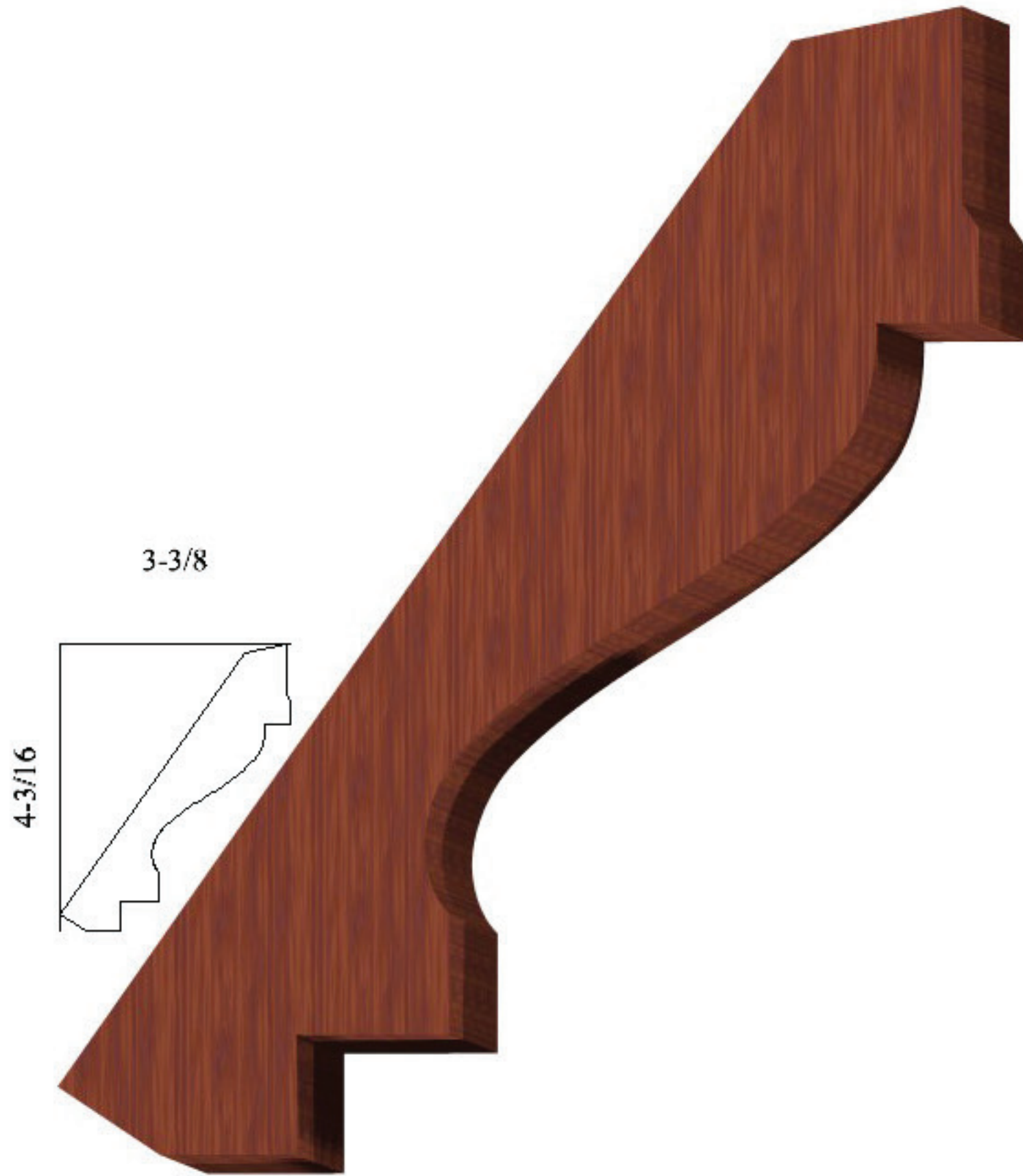

CR102
1 x 5-3/16

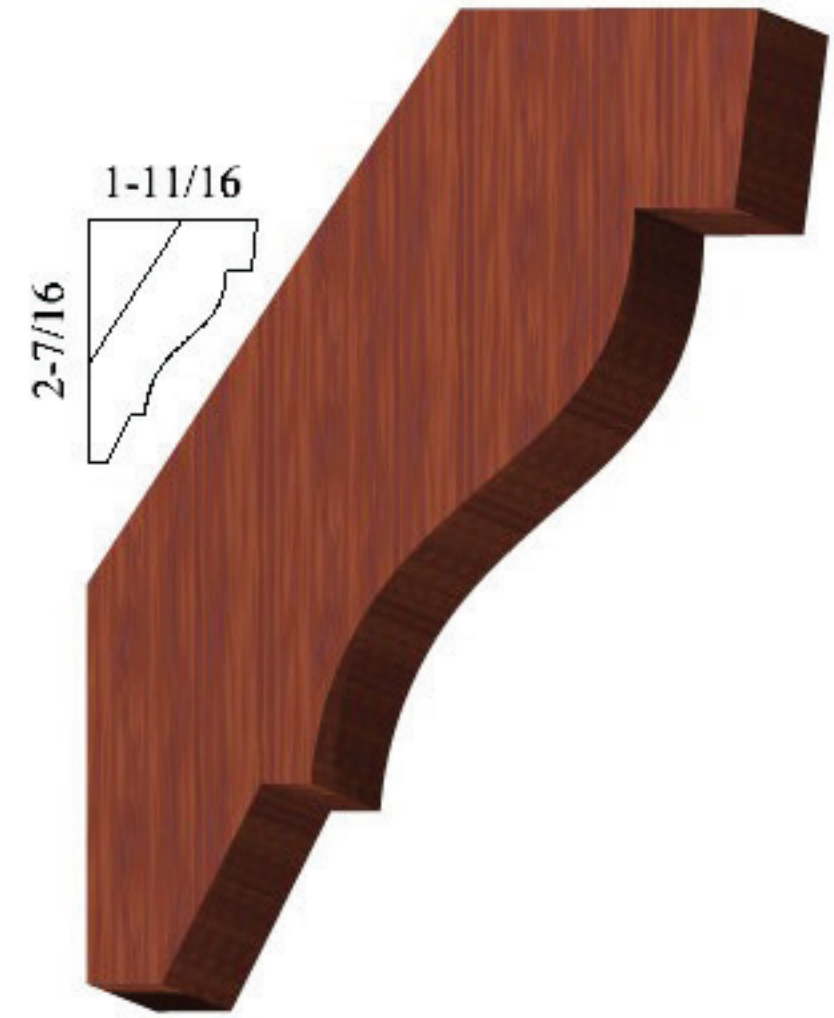

CR122
3/4 x 2-15/16



CR143
1/2 x 5/8



CR144
5/8 x 5/8



CR145
1/2 x 5/8



CR211
1-3/8 x 4-3/8



CR139
3/4 x 3

CASING

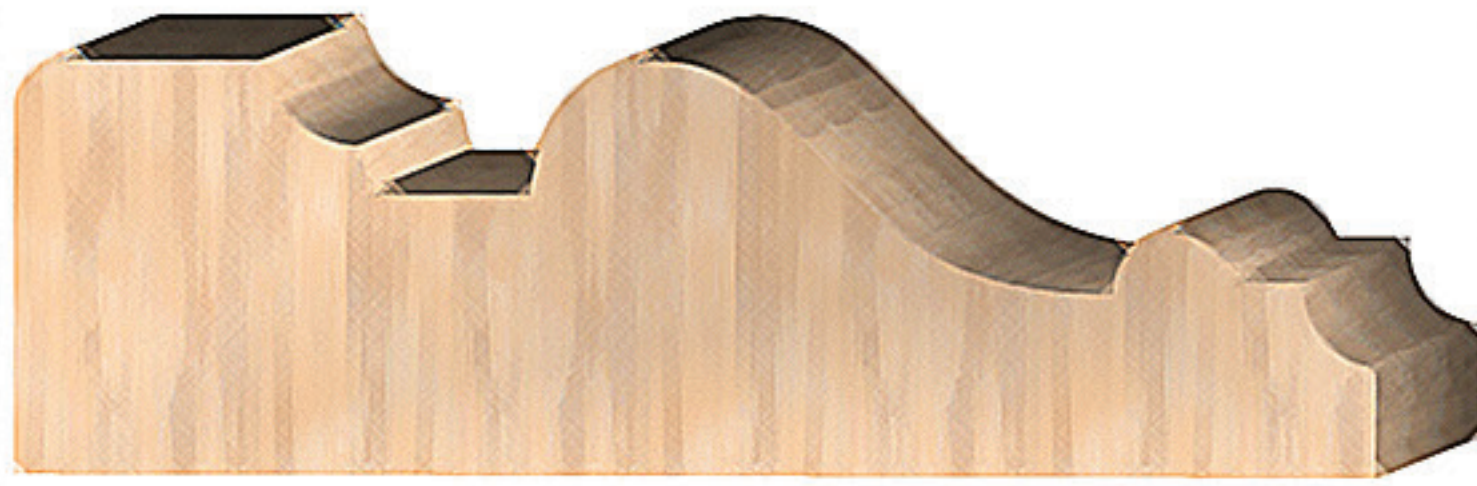

ID#	Page #	Dimension	ID#	Page #	Dimension
CA01	84	1 x 5-1/2	CA42	88	9/16 x 1-5/8
CA02	87	3/4 x 3-1/4	CA43	93	9/16 x 2-1/4
CA03	87	11/16 x 2-3/8	CA44	81	3/4 x 2-1/4
CA04	85	1-3/16 x 4-15/16	CA45	101	3/4 x 4
CA05	101	3/4 x 3	CA46	89	3/4 x 2-9/16
CA06	82	3/4 x 1-3/4	CA47	88	5/8 x 3-1/4
CA07	96	3/4 x 7-5/16	CA48	93	11/16 x 3-3/8
CA08	83	11/16 x 4-1/4	CA49	82	3/4 x 3-1/2
CA09	78	11/16 x 3-1/2	CA50	92	3/4 x 2-1/2
CA10	88	5/8 x 2-1/4	CA51	95	3/4 x 3-1/4
CA11	101	7/16 x 5	CA52	87	1 x 3-1/4
CA12	97	13/16 x 5-5/8	CA53	98	5/8 x 2-1/2
CA13	101	1-1/8 x 7-3/4	CA54	93	1/2 x 1-9/16
CA14	99	11/16 x 3-1/4	CA55	97	3/4 x 4-1/16
CA15	89	3/4 x 2-1/16	CA56	82	11/16 x 1-11/16
CA16	90	13/16 x 2-3/4	CA57	79	1-1/16 x 3-1/2
CA17	78	11/16 x 2-3/4	CA58	87	1-3/16 x 5
CA18	81	11/16 x 2-1/2	CA59	95	11/16 x 2-3/4
CA19	96	13/16 x 5-5/16	CA60	86	1-1/8 x 4-1/8
CA20	92	1 x 5-1/4	CA61	100	3/4 x 3-1/2
CA21	97	11/16 x 2-1/4	CA62	78	9/16 x 3-1/16
CA22	95	11/16 x 4-3/16	CA63	84	1-1/8 x 3-1/2
CA23	95	3/4 x 3-1/4	CA64	80	1-1/2 x 2-1/2
CA24	92	11/16 x 2-3/8	CA65	77	3/4 x -3-1/4
CA25	98	5/8 x 3-5/16	CA66	84	11/16 x 4-1/4
CA26	92	11/16 x 2-1/2	CA67	94	7/8 x 3-1/16
CA27	81	3/4 x 3-1/4	CA68	92	1-1/16 x 3-3/8
CA28	100	3/4 x 5-1/2	CA69	91	11/16 x 4-1/16
CA29	96	3/4 x 5-3/16	CA70	93	3/4 x 5-1/2
CA30	98	3/4 x 1-3/4	CA71	79	5/8 x 3-9/16
CA31	92	3/4 x 2-1/4	CA72	89	13/16 x 1-7/8
CA32	85	1-1/8 x 3-9/16	CA73	81	5/8 x 1-13/16
CA33	89	13/16 x 2-1/2	CA74	80	1-9/16 x 3-1/16
CA34	81	1-7/16 x 2	CA75	98	3/8 x 2-3/8
CA35	82	5/8 x 3-3/16	CA76	80	1-1/4 x 2-11/16
CA36	81	3/4 x 1-3/4	CA77	89	3/4 x 2-1/8
CA37	78	3/4 x 3	CA78	77	11/16 x 2-15/16
CA38	79	3/4 x 2-11/16	CA79	89	3/4 x 2-7/8
CA39	79	13/16 x 2-7/16	CA80	82	3/4 x 3-9/16
CA40	95	3/4 x 4-3/8	CA81	97	1/2 x 2-3/4
CA41	95	3/4 x 4-3/8	CA82	90	1-7/8 x 2-1/2

ID#	Page #	Dimension	ID#	Page #	Dimension
CA83	77	11/16 x 3-3/16	CA124	94	11/16 x 5-1/16
CA84	97	9/16 x 4-1/16	CA125	100	3/4 x 5-5/16
CA85	86	1-7/16 x 5-1/8	CA126	98	9/16 x 2-1/4
CA86	98	13/16 x 5-1/2	CA127	82	1 x 3
CA87	81	3/4 x 2-11/16	CA128	96	3/4 x 5-1/2
CA88	80	1-3/8 x 2-1/2	CA129	90	3/4 x 2
CA89	80	1-1/8 x 3-7/16	CA130	82	3/4 x 2-11/16
CA90	89	3/4 x 2-13/16	CA131	91	11/16 x 3-1/2
CA91	95	3/4 x 3-1/4	CA132	78	13/16 x 5-5/16
CA92	101	1-1/4 x 5	CA133	95	3/4 x 3-1/16
CA93	78	13/16 x 2-3/4	CA134	83	3/4 x 3-9/16
CA94	81	3/4 x 2-5/16	CA135	99	3/4 x 4-1/4
CA95	82	3/4 x 1-3/4	CA136	93	3/4 x 3-3/8
CA96	-	-	CA137	99	3/4 x 6
CA97	100	3/4 x 3-5/16	CA138	87	1 x 4-1/16
CA98	89	3/4 x 1-1/2	CA139	88	3/4 x 2-1/4
CA99	95	1/2 x 2-3/8	CA140	81	13/16 x 3-1/2
CA100	80	1-1/8 x 2-1/8	CA141	98	3/8 x 2-1/4
CA101	91	15/16 x 2-1/2	CA142	80	1-1/4 x 3-1/2
CA102	91	7/8 x 2-1/16	CA143	99	3/4 x 3
CA103	91	1-1/4 x 1-11/16	CA144	89	13/16 x 2
CA104	85	1-3/4 x 4-1/8	CA145	86	1-3/8 x 4-1/2
CA105	91	1-1/16 x 3-3/8	CA146	-	-
CA106	85	1-1/4 x 3-5/16	CA147	94	3/4 x 3-1/2
CA107	88	11/16 x 2-5/16	CA148	82	3/4 x 2-11/16
CA108	77	1-1/8 x 4-13/16	CA149	-	-
CA109	86	1-3/4 x 4-5/8	CA150	100	1 x 5
CA110	92	11/16 x 2-7/16	CA151	83	3/4 x 4-3/8
CA111	79	3/4 x 2-1/2	CA152	83	3/4 x 3-1/16
CA112	88	5/8 x 2-5/8	CA153	84	3/4 x 3-5/8
CA113	87	1 x 5-1/16	CA154	83	3/4 x 3-7/16
CA114	89	13/16 x 3-9/16	CA155	90	3/4 x 2
CA115	78	5/8 x 2-1/2	CA156	90	3/4 x 2-5/16
CA116	92	11/16 x 2-1/2	CA157	98	11/16 x 4-1/2
CA117	77	13/16 x 3-1/4	CA158	102	1-3/4 x 10
CA118	88	3/4 x 3-3/8	CA159	91	11/16 x 3-1/4
CA119	82	3/4 x 3-3/8	CA160	85	1-7/16 x 3-3/8
CA120	92	3/4 x 3-3/8	CA161	88	3/4 x 2-1/2
CA121	82	3/4 x 4	CA162	96	7/8 x 4-7/8
CA122	94	11/16 x 3-1/16	CA163	90	13/16 x 3-1/2
CA123	78	13/16 x 5	CA164	77	7/8 x 4-1/4

ID#	Page #	Dimension	ID#	Page #	Dimension
CA165	89	11/16 x 2-5/16	CA206	-	-
CA166	85	1-3/8 x 3-5/16	CA207	103	3/4 x 2-5/16
CA167	97	3/4 x 3-7/16			
CA168	90	1 x 3-3/16			
CA169	90	3/4 x 2-9/16			
CA170	90	5/8 x 3-3/16			
CA171	79	1-3/8 x 3-7/16			
CA172	83	3/4 x 3-5/8			
CA173	89	3/4 x 3			
CA174	80	1-1/16 x 2-9/16			
CA175	98	5/8 x 2-9/16			
CA176	90	5/8 x 2-1/4			
CA177	80	3/4 x 15/16			
CA178	87	1-3/16 x 4-1/2			
CA179	94	3/4 x 4-7/16			
CA180	89	5/8 x 3-3/16			
CA181	79	1-1/8 x 4-1/2			
CA182	79	1-1/8 x 3-3/8			
CA183	88	3/4 x 3-3/8			
CA184	93	7/8 x 4			
CA185	-	-			
CA186	88	3/8 x 2-1/2			
CA187	93	5/8 x 1-9/16			
CA188	90	3/4 x 2-1/4			
CA189	94	9/16 x 4-1/4			
CA190	89	9/16 x 1-5/8			
CA191	83	3/4 x 3-1/4			
CA192	84	13/16 x 4-1/2			
CA193	83	3/4 x 4-7/16			
CA194	93	11/16 x 3			
CA195	83	1-1/16 x 3-1/2			
CA196	77	1-1/4 x 6			
CA197	91	1-3/8 x 2-5/16			
CA198	90	5/8 x 2-1/2			
CA199	84	13/16 x 5-7/16			
CA200	103	1-1/8 x 4-1/8			
CA201	103	3/4 x 4-1/4			
CA202	103	3/4 x 3			
CA203	103	13/16 x 2-7/16			
CA204	103	13/16 x 3-1/16			
CA205	-	-			



CA196 1-1/4 x 6



CA108 1-1/8 x 4-13/16

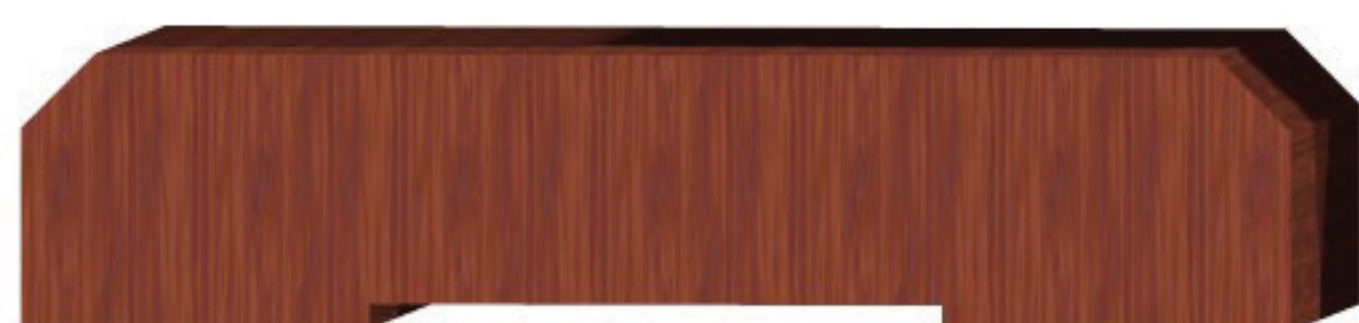

CA83 11/16 x 3-3/16



CA65 3/4 x 3-1/4

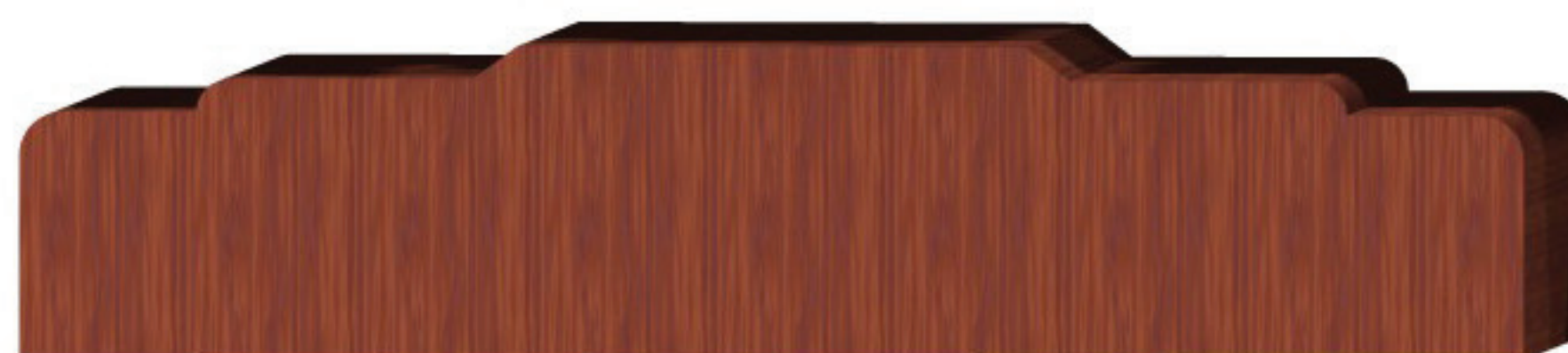

CA164 7/8 x 4-1/4



CA117 13/16 x 3-1/4



CA78 11/16 x 2-15/16



CA93 $13/16$ x $2-3/4$



CA115 $5/8$ x $2-1/2$

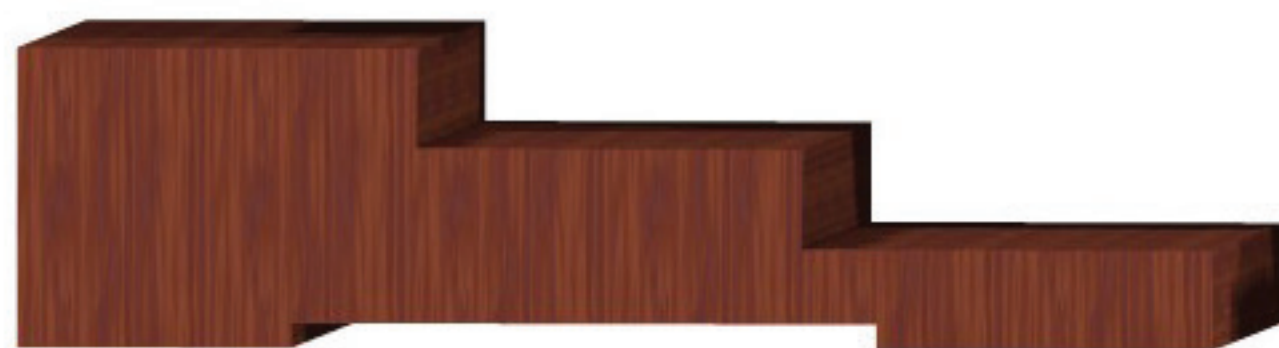

CA37 $3/4$ x 3



CA62 $9/16$ x $3-1/16$



CA17 $11/16$ x $2-3/4$



CA09 $11/16$ x $3-1/2$

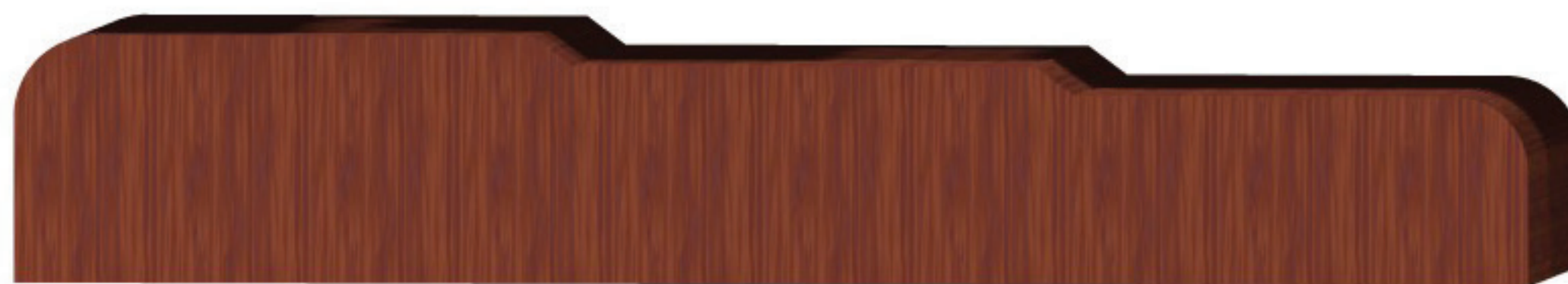

CA123 $13/16$ x 5



CA132 $13/16$ x $5-5/16$



CA181 1-1/8 x 4-1/2



CA71 5/8 x 3-9/16



CA111 3/4 x 2-1/2



CA39 13/16 x 2-7/16



CA57 1-1/16 x 3-1/2



CA38 3/4 x 2-11/16

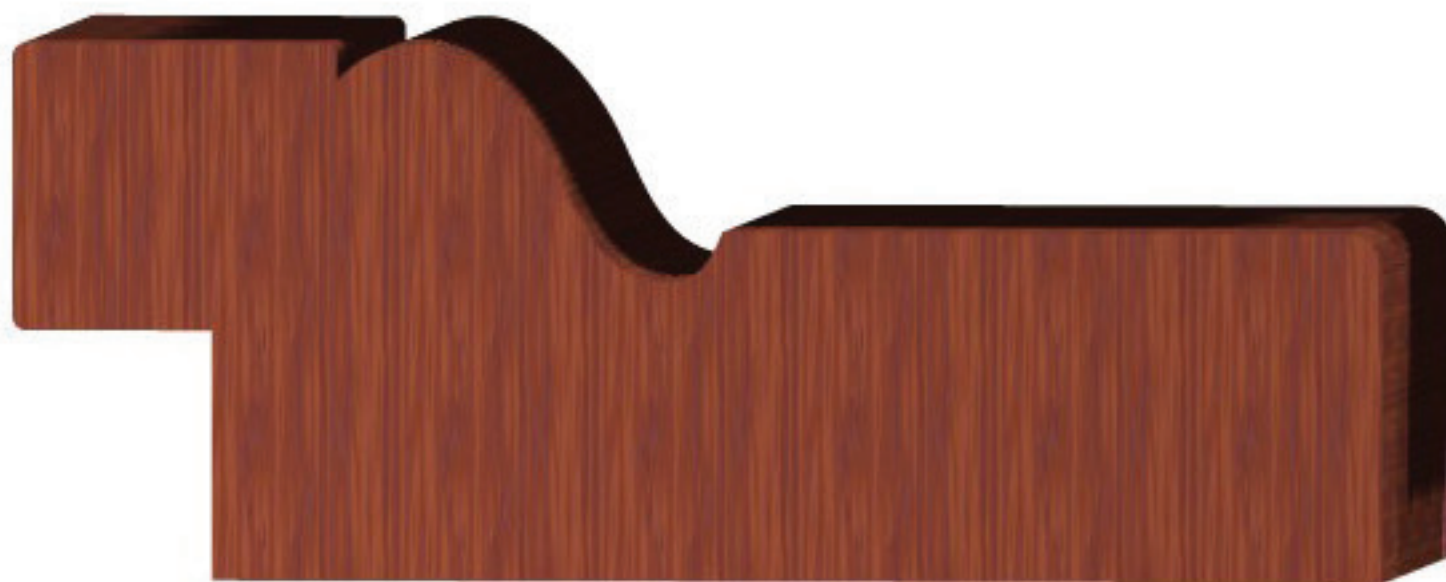

CA171 1-3/8 x 3-7/16



CA182 1-1/8 x 3-3/8

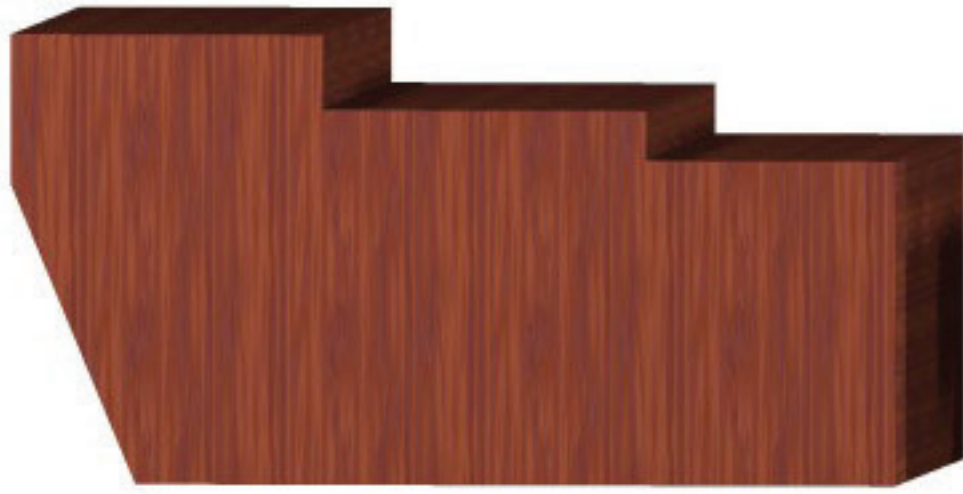

CA100 1-1/8 x 2-1/8



CA177
3/4 x 15/16



CA174 1-1/16 x 2-9/16



CA64 1-1/2 x 2-1/2



CA76 1-1/4 x 2-11/16



CA89 1-1/8 x 3-7/16



CA142 1-1/4 x 3-1/2



CA74 1-9/16 x 3-1/16

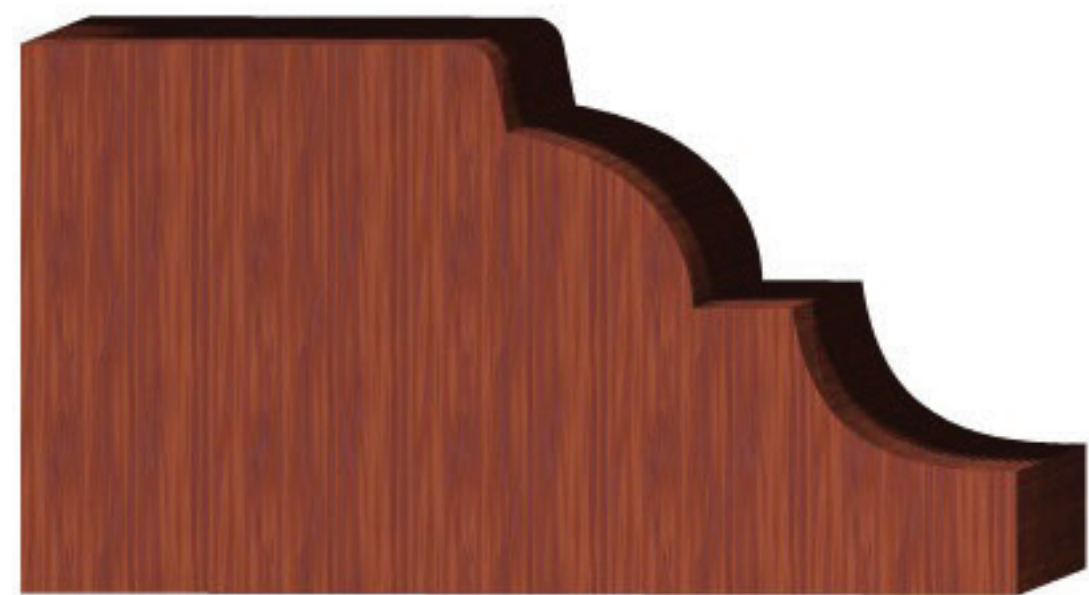

CA88 1-3/8 x 2-1/2



CA34 $1\frac{7}{16}$ x 2



CA44 $\frac{3}{4}$ x $2\frac{1}{4}$



CA36 $\frac{3}{4}$ x $1\frac{3}{4}$

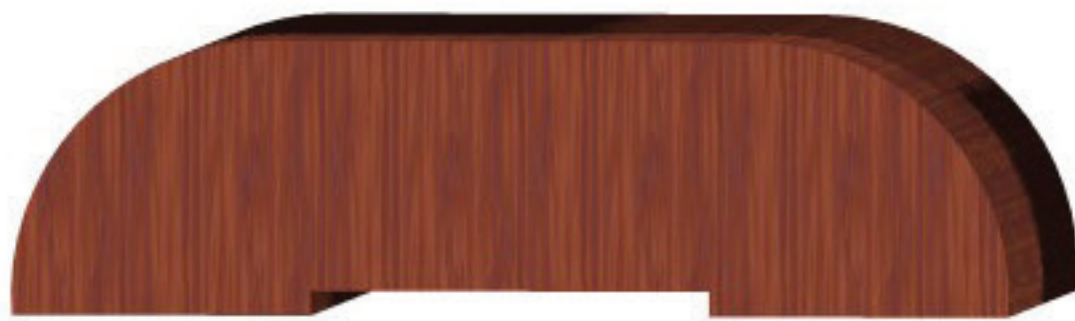

CA18 $\frac{11}{16}$ x $2\frac{1}{2}$



CA73 $\frac{5}{8}$ x $1\frac{13}{16}$



CA27 $\frac{3}{4}$ x $3\frac{1}{4}$



CA87 $\frac{3}{4}$ x $2\frac{11}{16}$



CA140 $\frac{13}{16}$ x $3\frac{1}{2}$



CA94 $\frac{3}{4}$ x $2\frac{5}{16}$



CA95 $\frac{3}{4}$ x $1\frac{3}{4}$



CA06 $\frac{3}{4}$ x $1\frac{3}{4}$



CA56 $\frac{11}{16}$ x $1\frac{11}{16}$



CA35 $\frac{5}{8}$ x $3\frac{3}{16}$



CA148 $\frac{3}{4}$ x $2\frac{11}{16}$



CA49 $\frac{3}{4}$ x $3\frac{1}{2}$



CA130 $\frac{3}{4}$ x $2\frac{11}{16}$



CA80 $\frac{3}{4}$ x $3\frac{9}{16}$

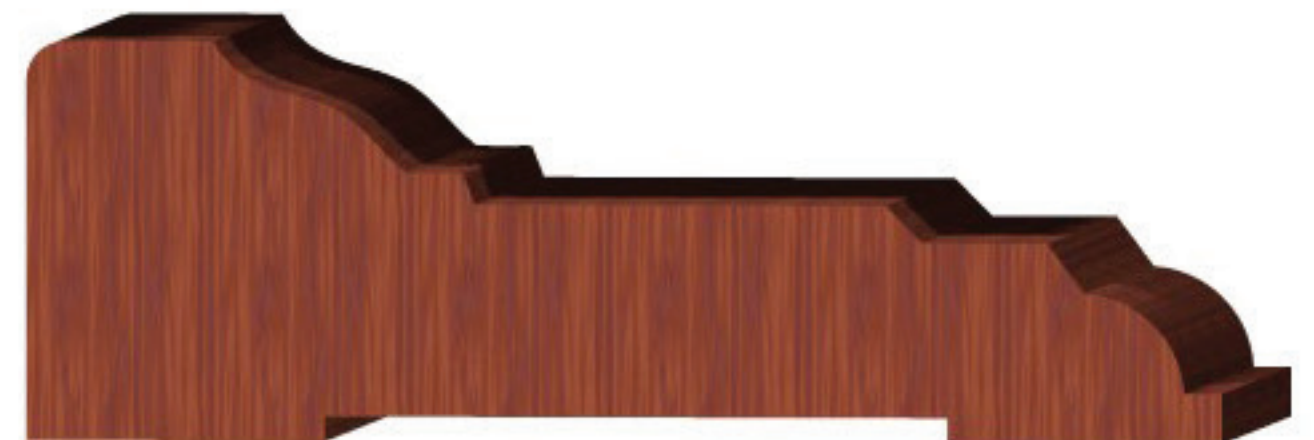

CA127 1 x 3



CA121 $\frac{3}{4}$ x 4



CA119 $\frac{3}{4}$ x $3\frac{3}{8}$



CA08 11/16 X 4-1/4



CA134 3/4 x 3-9/16



CA152 3/4 x 3-1/16

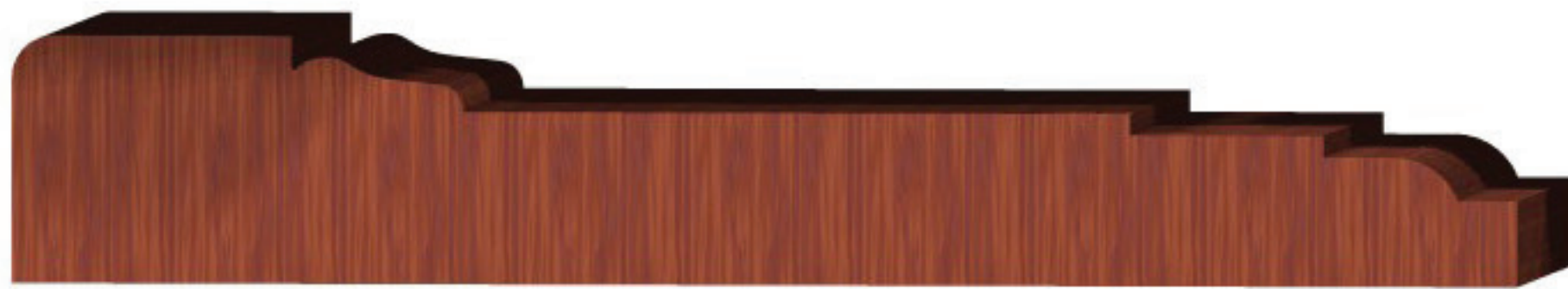

CA151 3/4 x 4-3/8



CA154 3/4 x 3-7/16



CA191 3/4 x 3-1/4



CA193 3/4 x 4-7/16



CA195 1-1/16 x 3-1/2



CA172 3/4 x 3-5/8



CA153 $\frac{3}{4}$ x $3\frac{5}{8}$

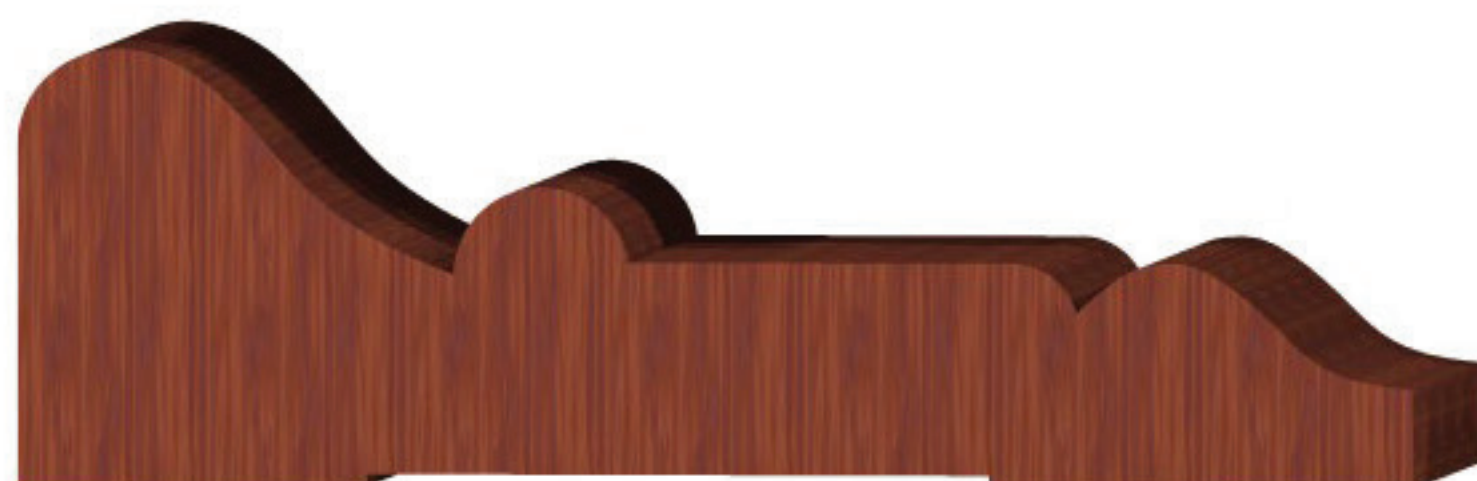

CA63 $1\frac{1}{8}$ x $3\frac{1}{2}$



CA66 $\frac{11}{16}$ x $4\frac{1}{4}$

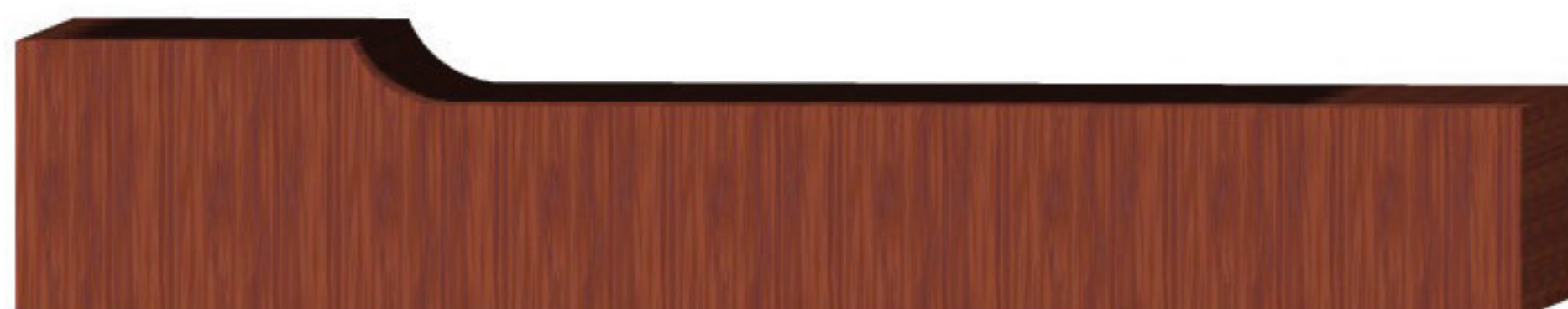

CA192 $\frac{13}{16}$ x $4\frac{1}{2}$



CA199 $\frac{13}{16}$ x $5\frac{7}{16}$



CA01 1 x $5\frac{1}{2}$

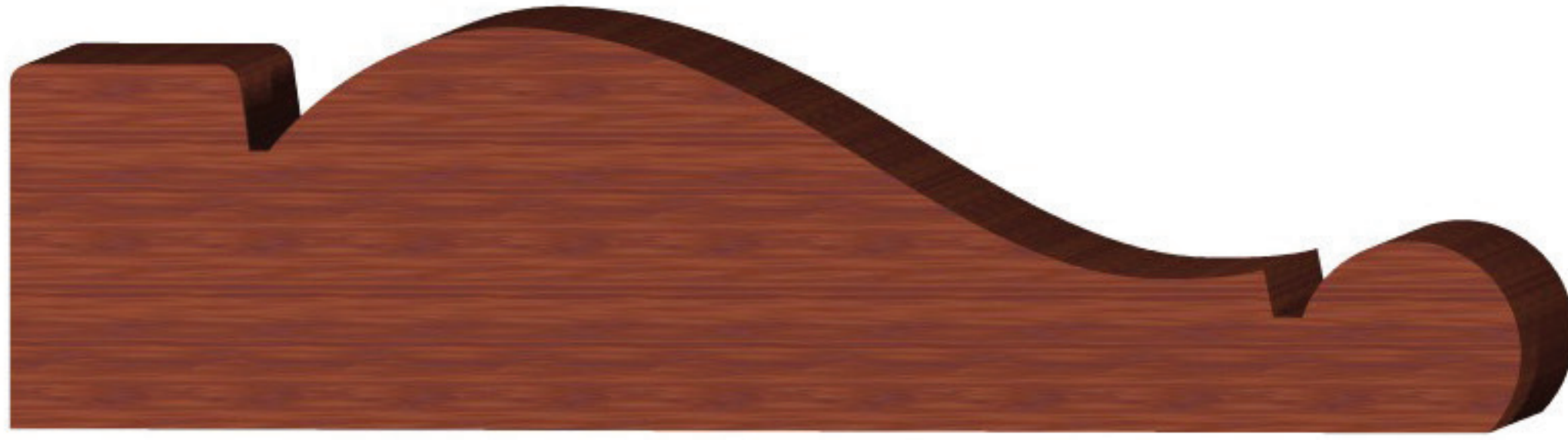

CA04 1-3/16 x 4-15/16



CA32 1-1/8 x 3-9/16



CA106 1-1/4 x 3-5/16



CA160 1-7/16 x 3-3/8



CA166 1-3/8 x 3-5/16



CA104 1-3/4 x 4-1/8



CA60 1-1/8 x 4-1/8

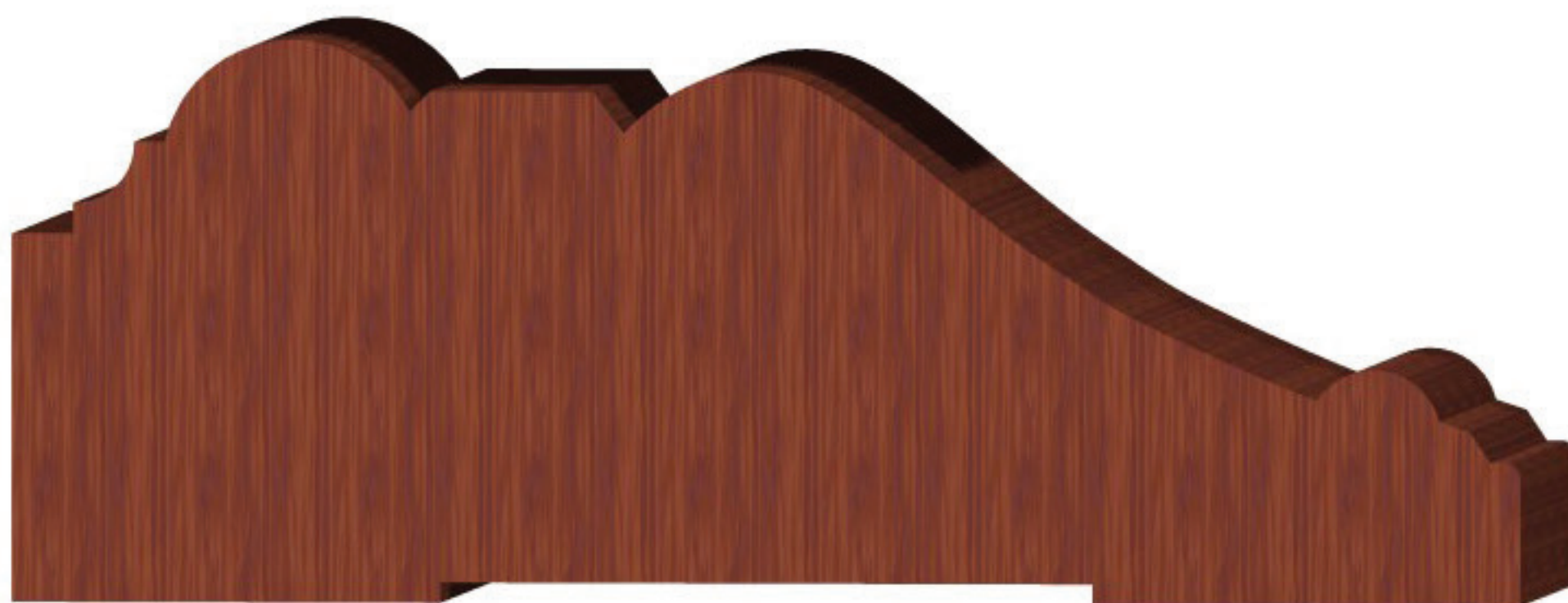

CA109 1-3/4 x 4-5/8

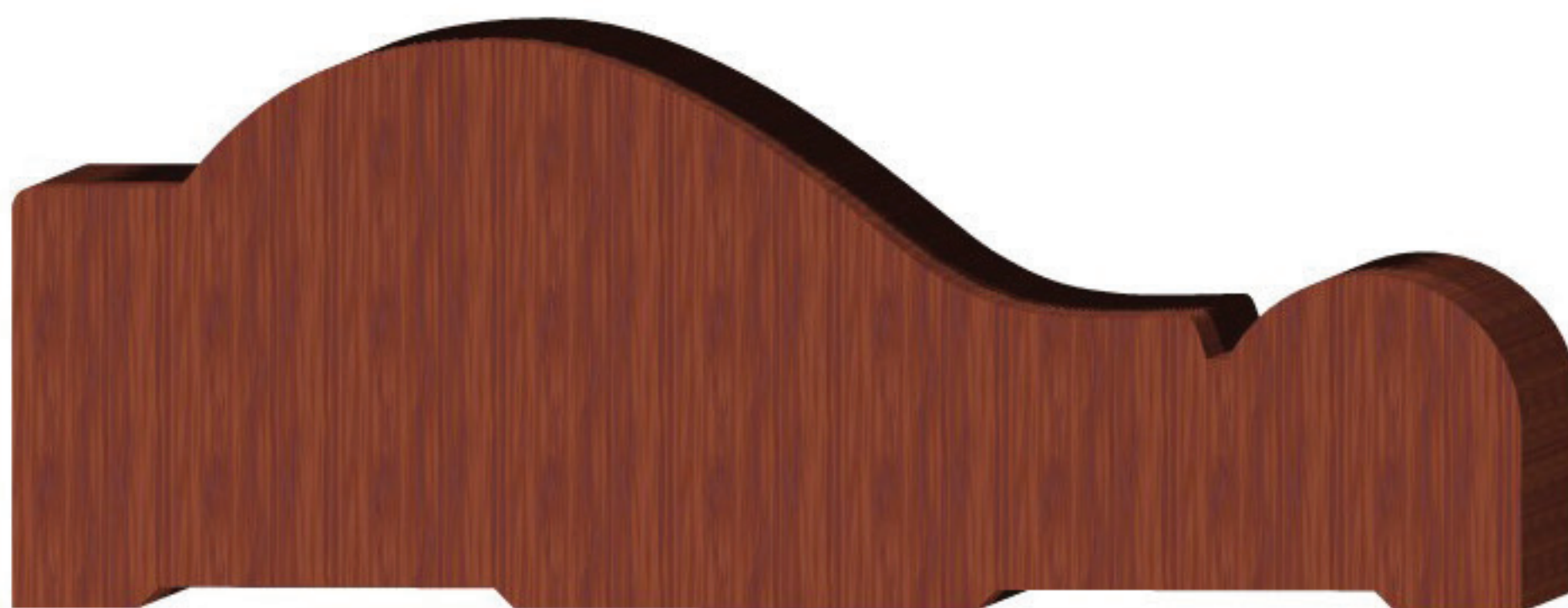

CA145 1-3/8 x 4-1/2

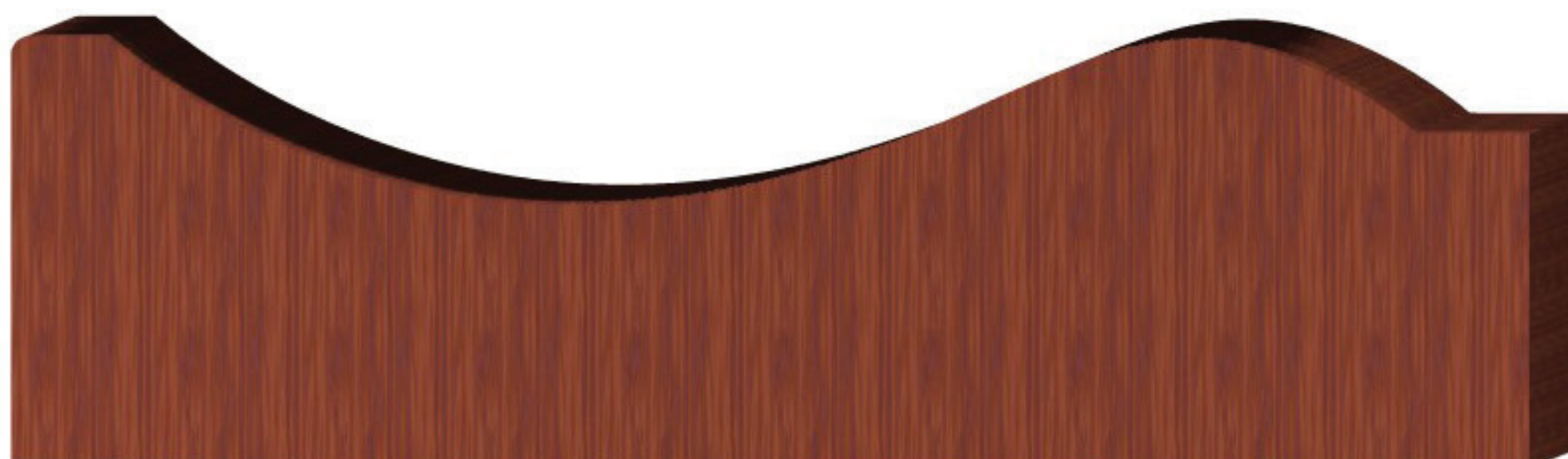

CA85 1-7/16 x 5-1/8

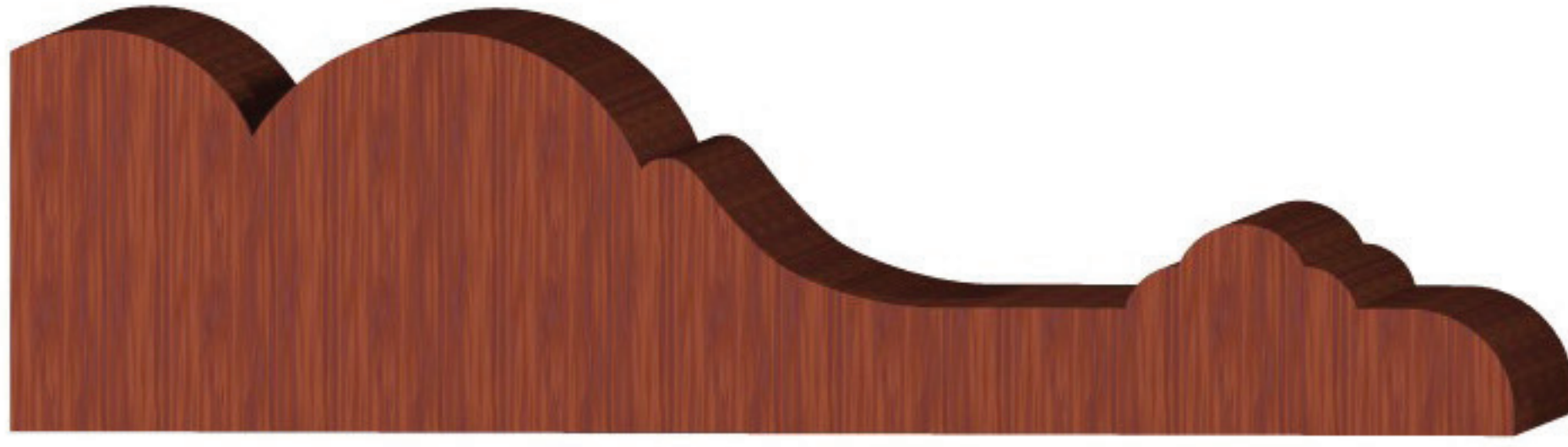

CA178 1-3/16 x 4-1/2



CA52 1 x 3-1/4



CA02 3/4 x 3-1/4



CA138 1 x 4-1/16



CA03 11/16 x 2-3/8



CA113 1 x 5-1/16



CA58 1-3/16 x 5



CA10 $\frac{5}{8}$ x $2 \frac{1}{4}$



CA42 $\frac{9}{16}$ x $1 \frac{5}{8}$



CA112 $\frac{5}{8}$ x $2 \frac{5}{8}$



CA139 $\frac{3}{4}$ x $2 \frac{1}{4}$



CA47 $\frac{5}{8}$ x $3 \frac{1}{4}$

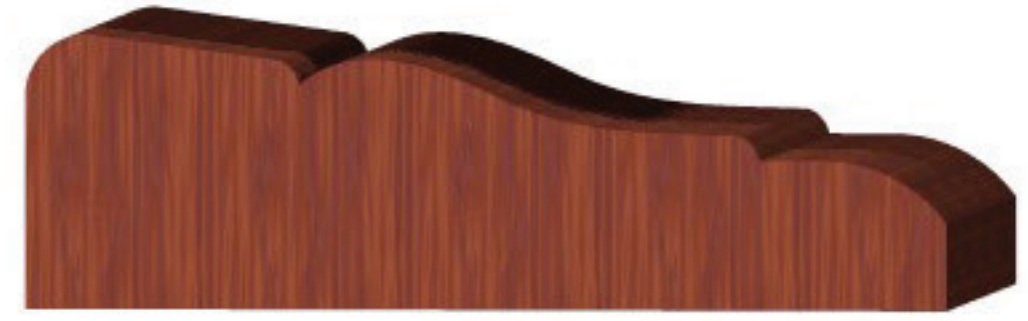

CA107 $\frac{11}{16}$ x $2 \frac{5}{16}$



CA118 $\frac{3}{4}$ x $3 \frac{3}{8}$



CA161 $\frac{3}{4}$ x $2 \frac{1}{2}$



CA183 $\frac{3}{4}$ x $3 \frac{3}{8}$



CA186 $\frac{3}{8}$ x $2 \frac{1}{2}$



CA15 $\frac{3}{4}$ x $2\frac{-1}{16}$



CA190 $\frac{9}{16}$ x $1\frac{-5}{8}$

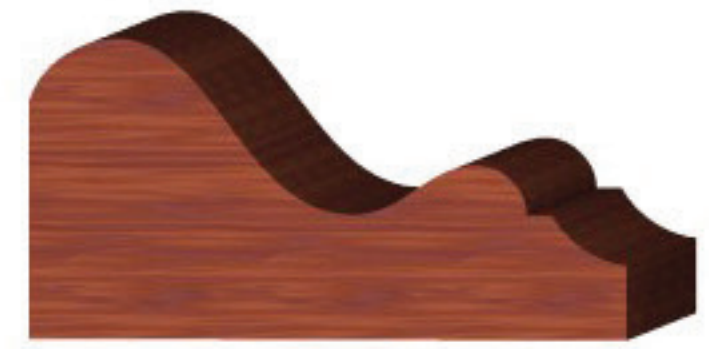

CA98 $\frac{3}{4}$ x $1\frac{-1}{2}$



CA77 $\frac{3}{4}$ x $2\frac{-1}{8}$



CA72 $\frac{13}{16}$ x $1\frac{-7}{8}$



CA144 $\frac{13}{16}$ x 2



CA90 $\frac{3}{4}$ x $2\frac{-13}{16}$



CA79 $\frac{3}{4}$ x $2\frac{-7}{8}$



CA114 $\frac{13}{16}$ x $3\frac{-9}{16}$



CA180 $\frac{5}{8}$ x $3\frac{-3}{16}$



CA33 $\frac{13}{16}$ x $2\frac{-1}{2}$



CA165 $\frac{11}{16}$ x $2\frac{-5}{16}$



CA173 $\frac{3}{4}$ x 3



CA46 $\frac{3}{4}$ x $2\frac{-9}{16}$



CA198 $\frac{5}{8}$ x $2\frac{1}{2}$



CA176 $\frac{5}{8}$ x $2\frac{1}{4}$



CA188 $\frac{3}{4}$ x $2\frac{1}{4}$



CA129 $\frac{3}{4}$ x 2



CA169 $\frac{3}{4}$ x $2\frac{9}{16}$



CA82 $1\frac{7}{8}$ x $2\frac{1}{2}$

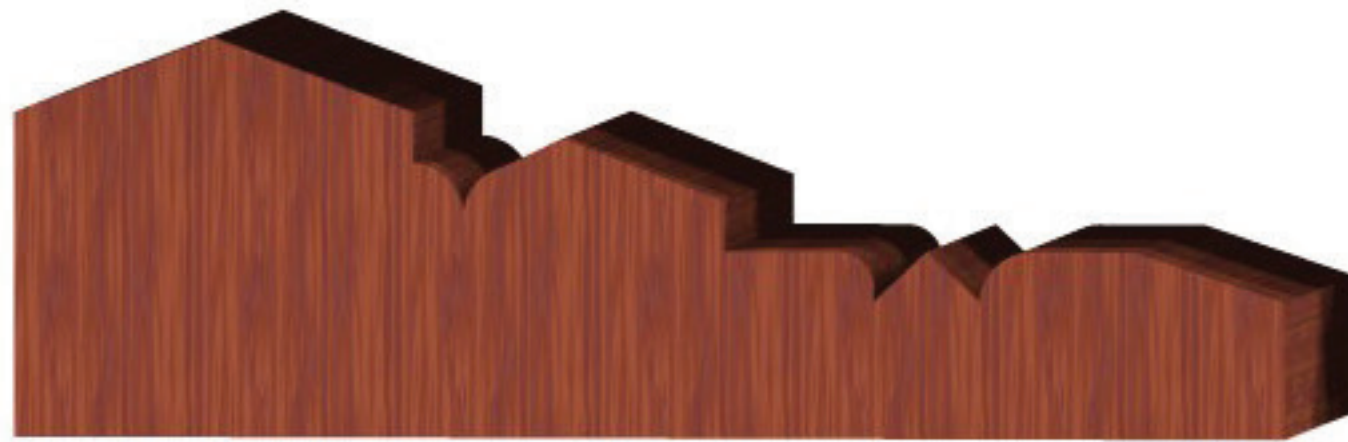

CA168 1 x $3\frac{3}{16}$



CA155 $\frac{3}{4}$ x 2



CA170 $\frac{5}{8}$ x $3\frac{3}{16}$



CA156 $\frac{3}{4}$ x $2\frac{5}{16}$



CA163 $\frac{13}{16}$ x $3\frac{1}{2}$



CA16 $\frac{13}{16}$ x $2\frac{3}{4}$



CA131 $1\frac{11}{16}$ x $3\frac{1}{2}$



CA102 $\frac{7}{8}$ x $2\frac{1}{16}$



CA103 $1\frac{1}{4}$ x $1\frac{11}{16}$



CA69 $1\frac{11}{16}$ x $4\frac{1}{16}$



CA159 $1\frac{11}{16}$ x $3\frac{1}{4}$



CA101 $1\frac{15}{16}$ x $2\frac{1}{2}$



CA105 $1\frac{1}{16}$ x $3\frac{3}{8}$



CA197 $1\frac{3}{8}$ x $2\frac{5}{16}$



CA116 $11/16 \times 2-1/2$



CA50 $3/4 \times 2-1/2$



CA120 $3/4 \times 3-3/8$



CA31 $3/4 \times 2-1/4$



CA110 $11/16 \times 2-7/16$



CA26 $11/16 \times 2-1/2$

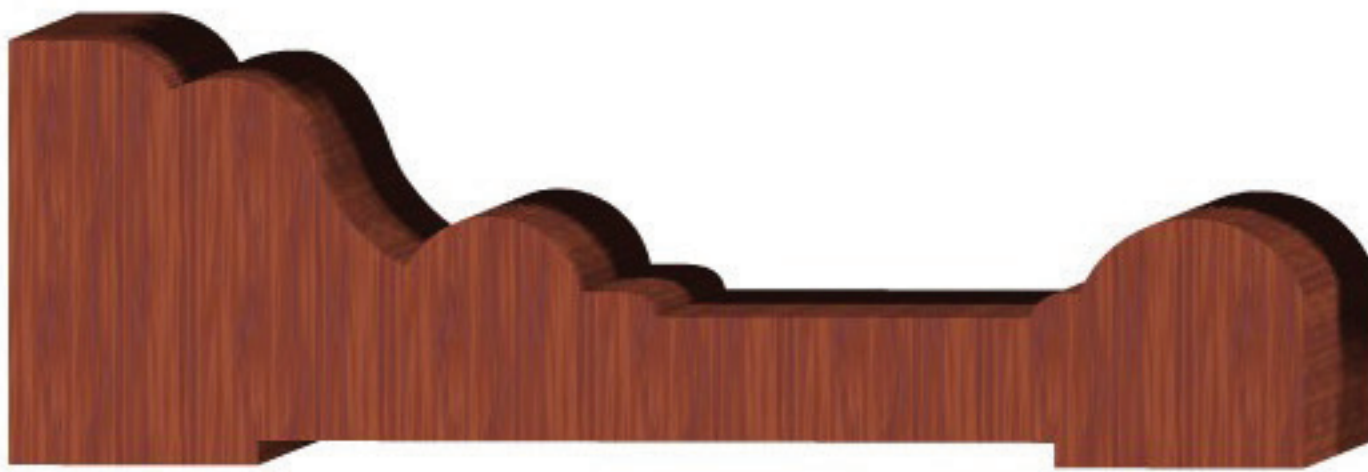

CA68 $1-1/16 \times 3-3/8$



CA24 $11/16 \times 2-3/8$

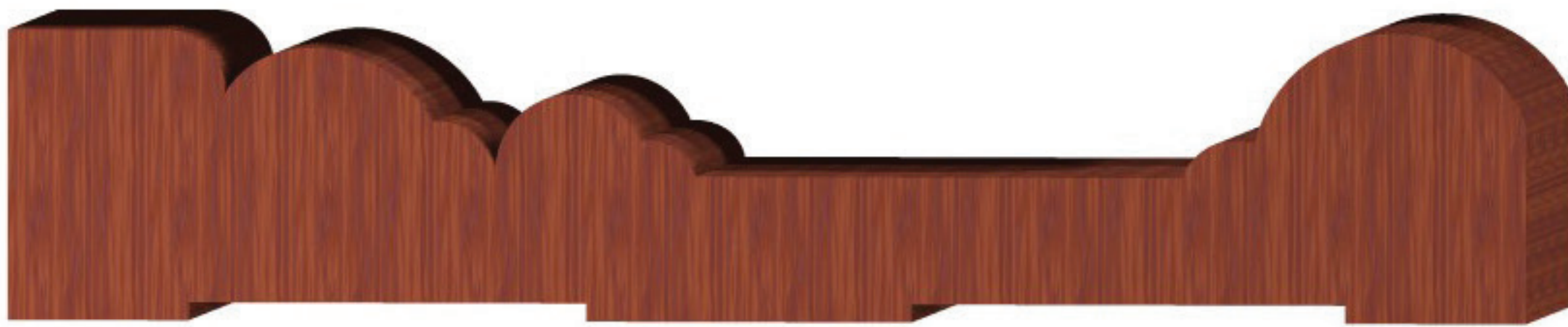

CA20 $1 \times 5-1/4$

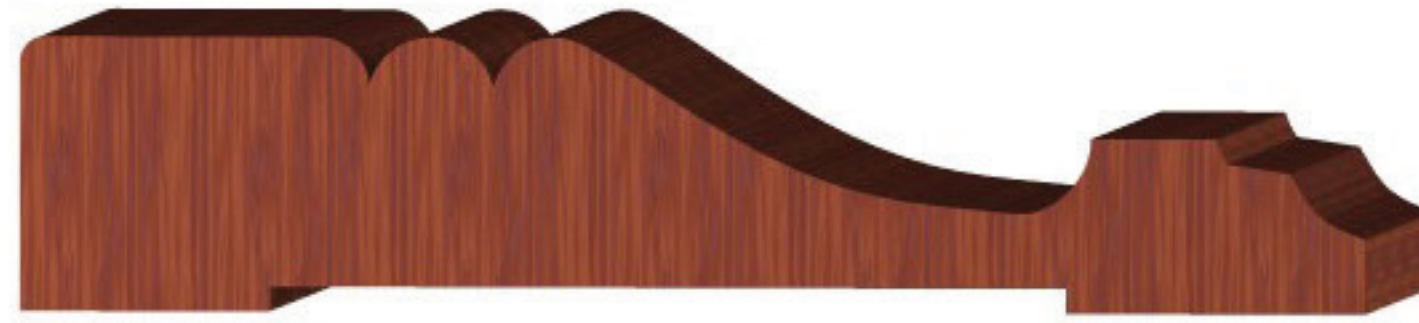

CA48 $11/16 \times 3-3/8$



CA136 $3/4 \times 3-3/8$



CA187 $5/8 \times 1-9/16$



CA184 $7/8 \times 4$



CA43 $9/16 \times 2-1/4$



CA54 $1/2 \times 1-9/16$



CA194 $11/16 \times 3$

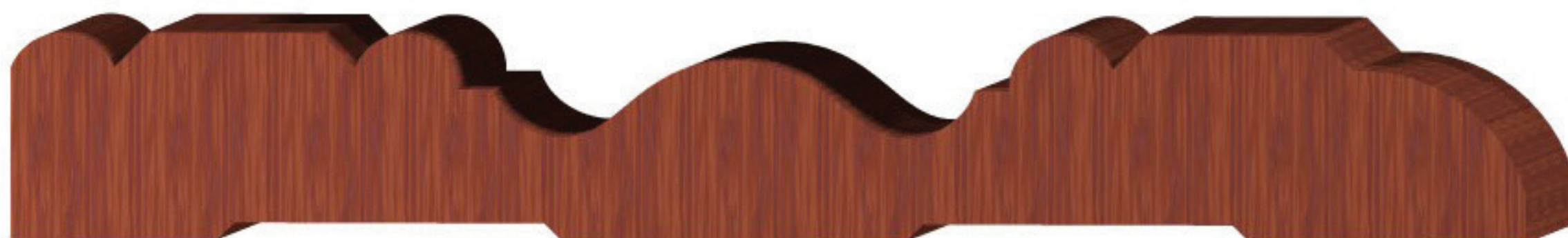

CA70 $3/4 \times 5-1/2$



CA124 $1\frac{1}{16}$ x $5\frac{1}{16}$



CA122 $1\frac{1}{16}$ x $3\frac{1}{16}$

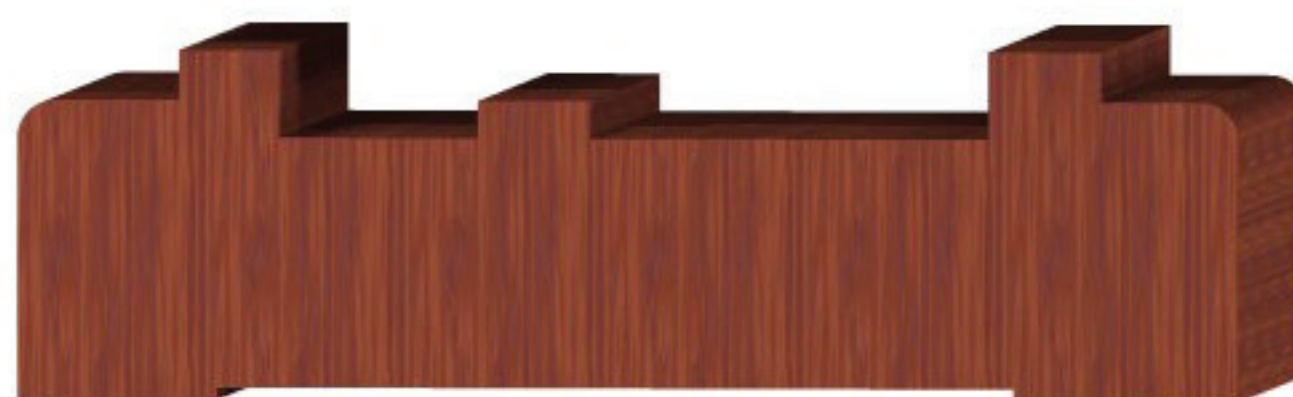

CA67 $\frac{7}{8}$ x $3\frac{1}{16}$



CA147 $\frac{3}{4}$ x $3\frac{1}{2}$

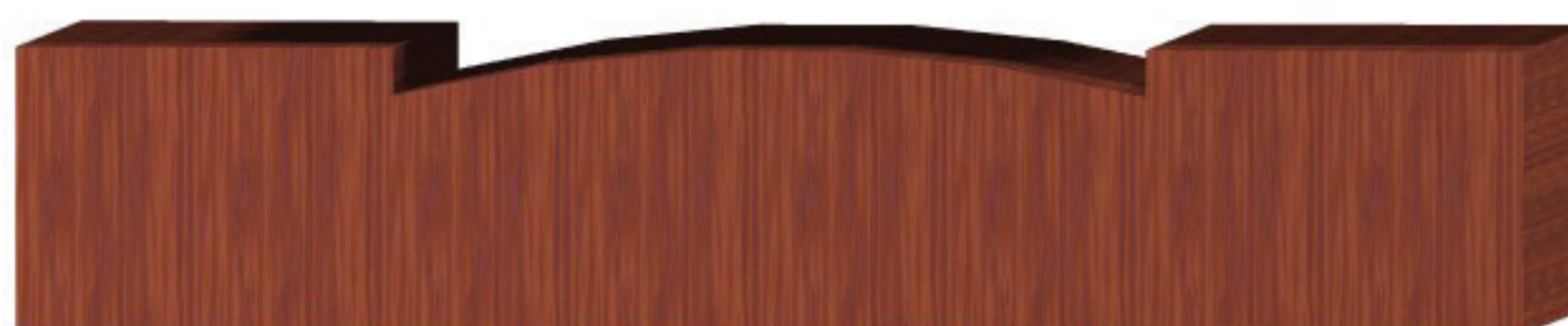

CA179 $\frac{3}{4}$ x 4



CA189 $\frac{9}{16}$ x $4\frac{1}{4}$



CA91 $\frac{3}{4}$ x $3\frac{1}{4}$



CA99 $\frac{1}{2}$ x $2\frac{3}{8}$



CA23 $\frac{3}{4}$ x $3\frac{1}{4}$



CA59 $\frac{11}{16}$ x $2\frac{3}{4}$



CA51 $\frac{3}{4}$ x $3\frac{1}{4}$

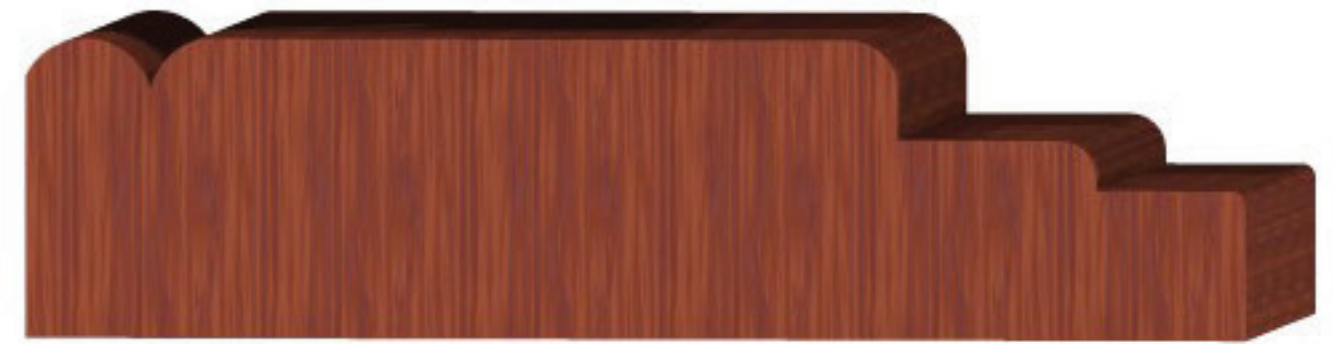

CA133 $\frac{3}{4}$ x $3\frac{1}{16}$



CA41 $\frac{3}{4}$ x $4\frac{3}{8}$



CA40 $\frac{3}{4}$ x $4\frac{3}{8}$



CA22 $\frac{11}{16}$ x $4\frac{3}{16}$

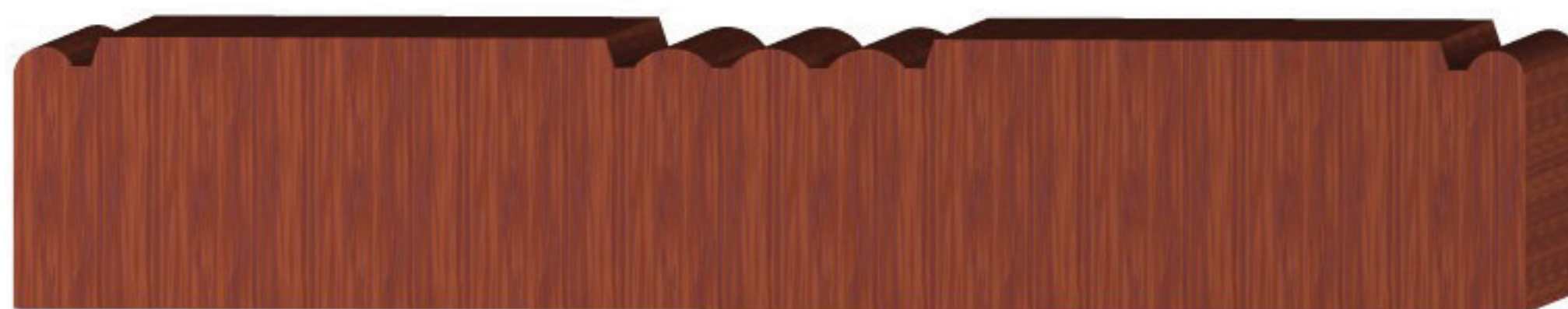

CA162 $\frac{7}{8}$ x $4\frac{7}{8}$

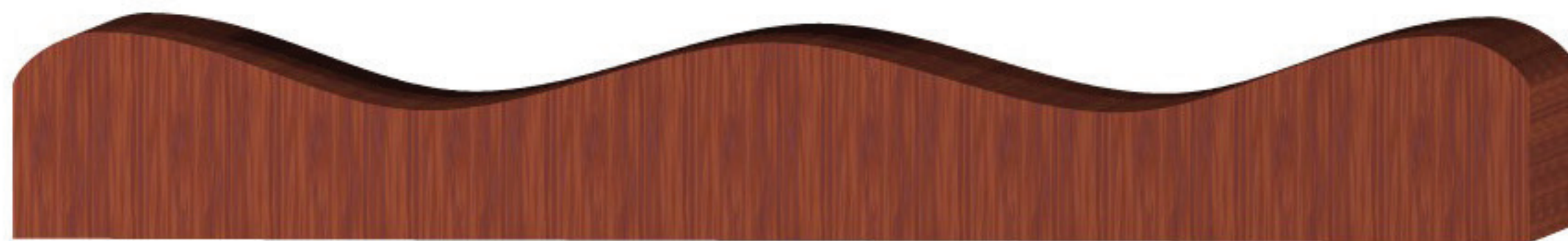

CA128 $\frac{3}{4}$ x $5\frac{1}{2}$



CA19 $\frac{13}{16}$ x $5\frac{5}{16}$



CA29 $\frac{3}{4}$ x $5\frac{3}{16}$



CA07 $\frac{3}{4}$ x $7\frac{5}{16}$



CA81 $1/2$ x $2-3/4$

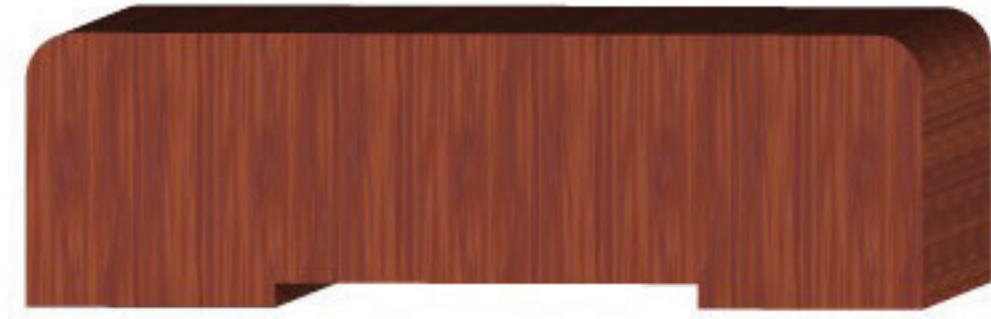

CA21 $11/16$ x $2-1/4$



CA167 $3/4$ x $3-7/16$



CA84 $9/16$ x $4-1/16$



CA55 $3/4$ x $4-1/16$



CA12 $13/16$ x $5-5/8$



CA75 $\frac{3}{8}$ x $2\text{-}\frac{3}{8}$



CA175 $\frac{5}{8}$ x $2\text{-}\frac{9}{16}$



CA30 $\frac{3}{4}$ x $1\text{-}\frac{3}{4}$



CA157 $\frac{11}{16}$ x $4\text{-}\frac{1}{2}$



CA86 $\frac{13}{16}$ x $5\text{-}\frac{1}{2}$



CA141 $\frac{3}{8}$ x $2\text{-}\frac{1}{4}$



CA53 $\frac{5}{8}$ x $2\text{-}\frac{1}{2}$



CA126 $\frac{9}{16}$ x $2\text{-}\frac{1}{4}$



CA25 $\frac{5}{8}$ x $3\text{-}\frac{5}{16}$



CA143 $\frac{3}{4}$ x 3

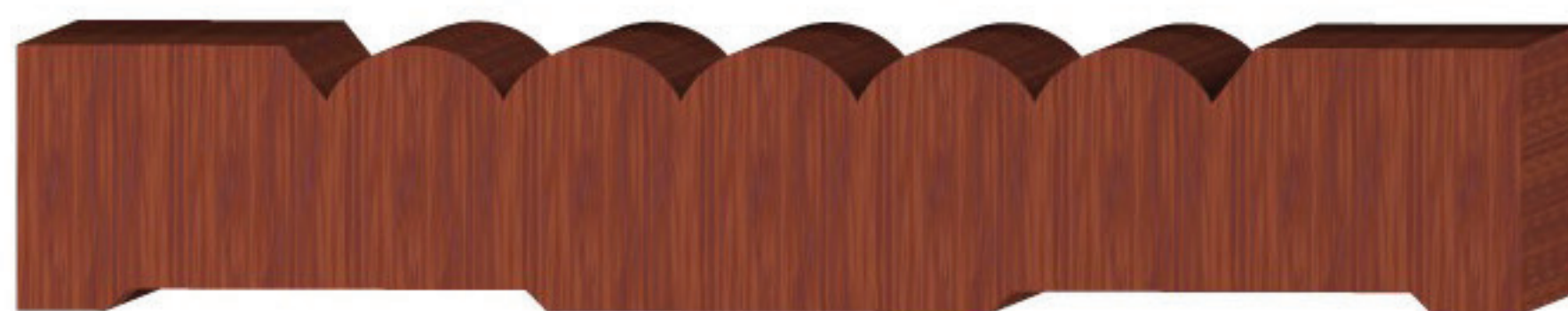

CA135 $\frac{3}{4}$ x 4- $\frac{1}{4}$

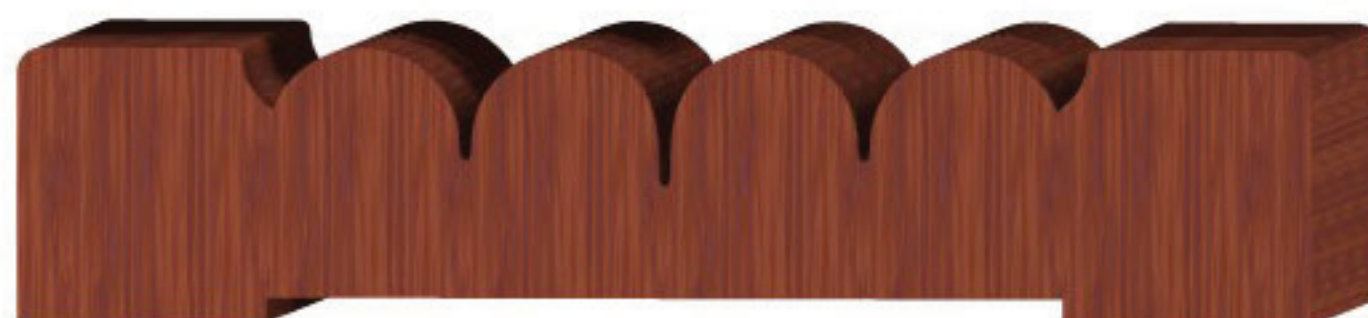

CA14 $\frac{11}{16}$ x 3- $\frac{1}{4}$

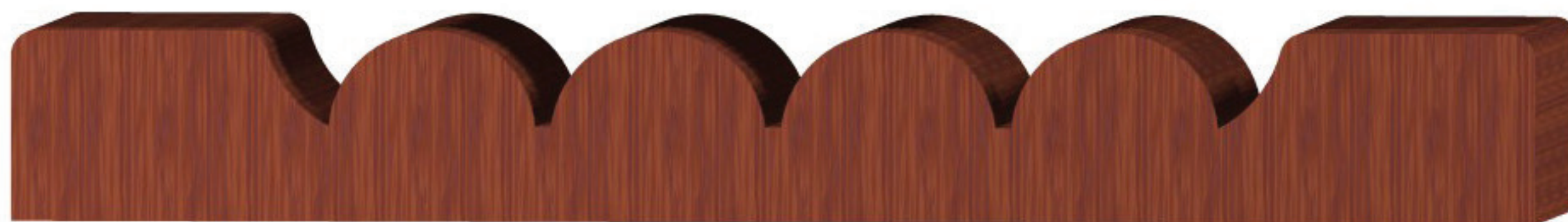

CA137 $\frac{3}{4}$ x 6



CA97 3/4 x 3-5/16

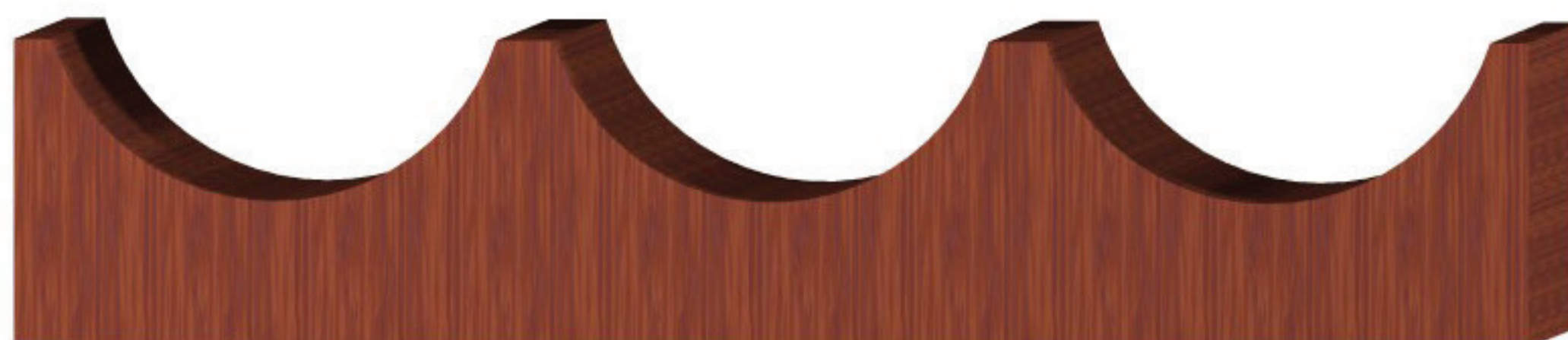

CA150 1 x 5



CA61 3/4 x 3-1/2



CA125 3/4 x 5-5/16



CA28 3/4 x 5-1/2



CA92 1-1/4 x 5



CA05 3/4 x 3

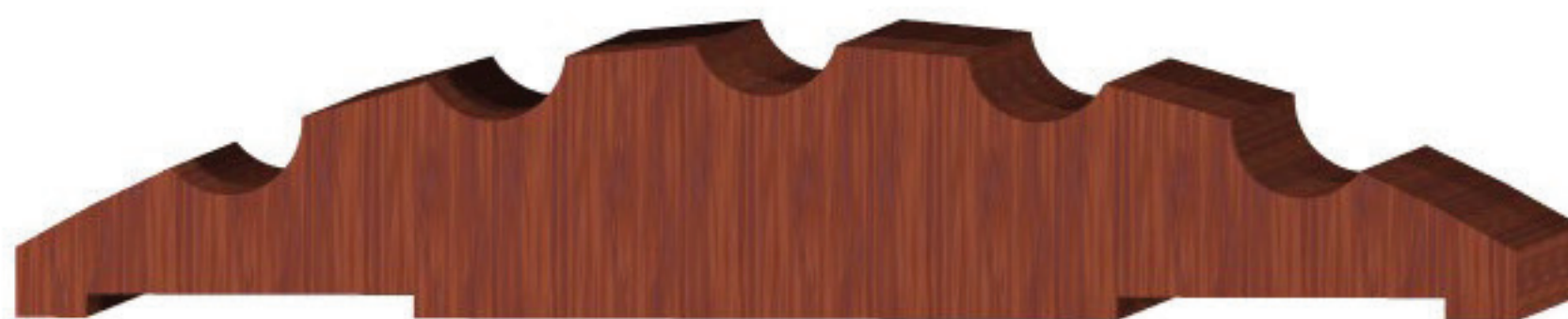

CA45 3/4 x 4



CA11 7/16 x 5

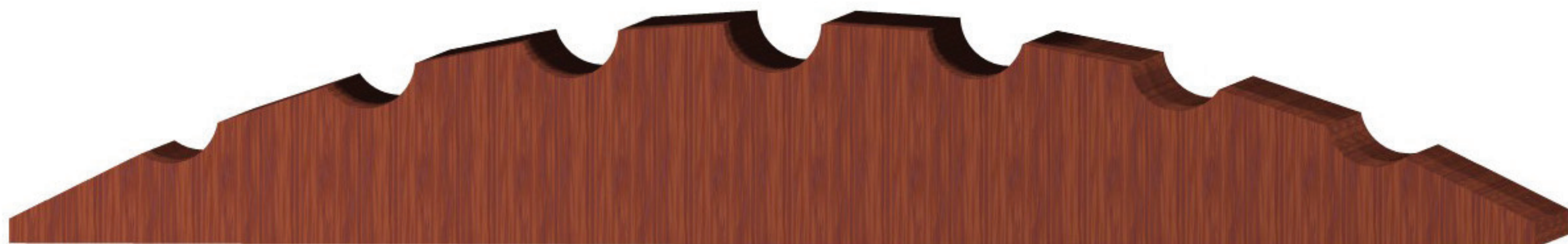

CA13 1-1/8 x 7-3/4



CA158
1-3/4 x 10



CA207 $\frac{3}{4}$ x $2\frac{5}{16}$

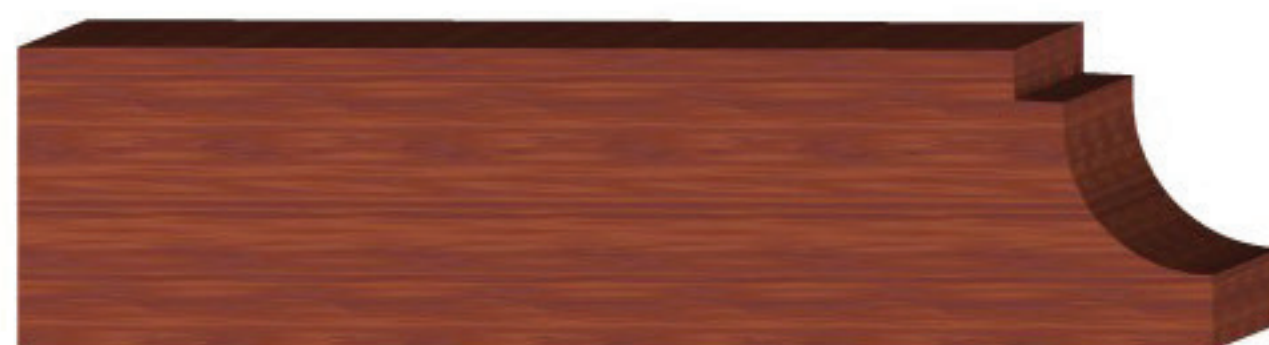

CA202 $\frac{3}{4}$ x 3



CA204 $\frac{13}{16}$ x $3\frac{1}{16}$



CA203 $\frac{13}{16}$ x $2\frac{7}{16}$

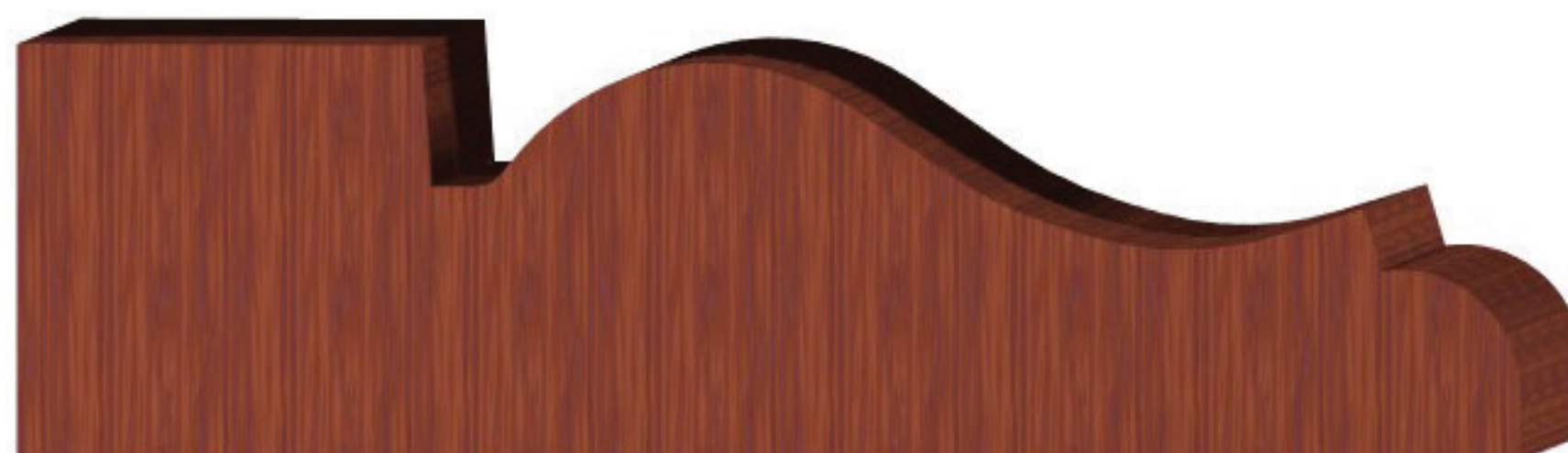

CA200 $1\frac{1}{8}$ x $4\frac{1}{8}$



CA201 $\frac{3}{4}$ x $4\frac{1}{4}$

MISCELLANEOUS

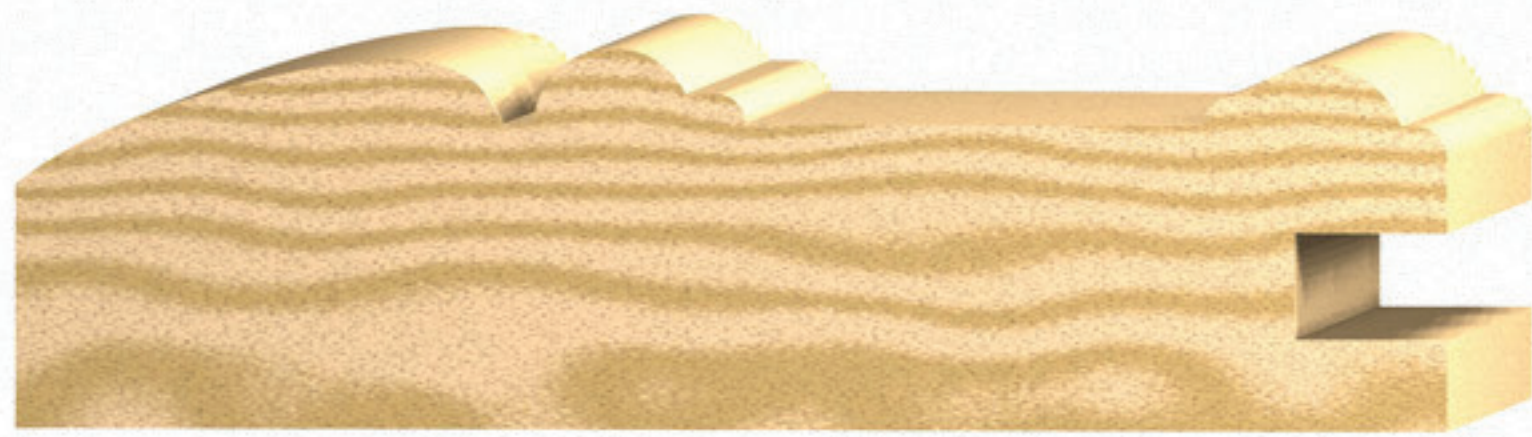

ID#	Page #	Dimension	ID#	Page #	Dimension
MS01	107	13/16 x 2-3/4	MS42	112	1-3/8 x 4-1/8
MS02	122	3/8 x 1	MS43	112	3/4 x 1-1/4
MS03	112	3/4 x 1-3/4	MS44	110	13/16 x 1-3/4
MS04	112	1-3/8 x 4-1/8	MS45	110	3/4 x 1-9/16
MS05	115	1-1/8 x 1-1/8	MS46	109	3/4 x 2-1/2
MS06	109	3/4 x 3/4	MS47	108	7/8 x 2-1/2
MS07	115	3/4 x 3/4	MS48	128	5/8 x 3-5/8
MS08	115	1-1/8 x 1-1/8	MS49	120	3/4 x 3-1/4
MS09	120	15/16 x 3-1/16	MS50	118	3/4 x 5-7/16
MS10	128	1-1/8 x 2-1/2	MS51	128	1-1/16 x 5-11/16
MS11	121	5/8 x 1-5/8	MS52	110	3/4 x 1-3/4
MS12	-	-	MS53	111	1/2 x 3/4
MS13	119	13/16 x 3-1/16	MS54	131	1/2 x 13/16
MS14	122	1/2 x 7/8	MS55	131	3/4 x 3/4
MS15	116	1 x 1-7/16	MS56	122	1/4 x 1
MS16	122	5/16 x 11/16	MS57	114	2 x 4
MS17	114	1-3/4 x 2-7/16	MS58	112	2-1/2 x 2-1/2
MS18	120	1-1/8 x 5	MS59	111	7/8 x 2-1/16
MS19	109	9/16 x 2-1/2	MS60	112	1-3/4 x 1-3/4
MS20	120	3/4 x 3-3/4	MS61	114	3/4 x 1-1/2
MS21	120	5/8 x 3-7/8	MS62	-	-
MS22	123	3/4 x 3-1/4	MS63	111	5/8 x 5/8
MS23	128	1-3/16 x 4-1/2	MS64	111	1/2 x 3/4
MS24	116	1-1/4 x 1-7/8	MS65	111	3/4 x 3/4
MS25	123	1 x 5-3/4	MS66	111	1/2 x 1/2
MS26	121	3/4 x 3-1/2	MS67	114	7/16 x 15/16
MS27	113	1-9/16 x 2-1/16	MS68	111	3/4 x 1-7/8
MS28	126	2-1/2 x 7	MS69	121	3/4 x 1-5/16
MS29	112	1-1/4 x 3-13/16	MS70	111	3/8 x 3/8
MS30	118	3/4 x 4-3/16	MS71	121	3/4 x 1-5/8
MS31	116	15/16 x 1	MS72	108	3/4 x 2-1/16
MS32	110	1-7/16 x 5-1/8	MS73	123	11/16 x 3-5/16
MS33	118	11/16 x 4-1/2 or 7-1/4	MS74	122	3/16 x 11/16
MS34	127	2-1/2 x 5-1/2	MS75	121	3/4 x 3/4
MS35	108	5/8 x 5-7/16	MS76	-	-
MS36	122	3/4 x 2-3/8	MS77	121	9/16 x 1-1/2
MS37	-	-	MS78	-	-
MS38	122	7/8 x 2-3/16	MS79	113	1-3/16 x 1-5/16
MS39	124	2-7/8 x 2-7/8	MS80	130	1-3/8 x 2-5/16
MS40	113	1-15/16 x 2-1/8	MS81	130	1-3/4 x 2-3/16
MS41	113	1-1/4 x 1-1/2	MS82	131	1/2 x 15/16

ID#	Page #	Dimension	ID#	Page #	Dimension
MS83	131	5/8 x 1-5/16	MS124	110	3/4 x 1-9/16
MS84	121	5/8 x 1-1/4	MS125	111	3/4 x 1-13/16
MS85	109	3/4 x 2-3/8	MS126	121	3/4 x 1-1/2
MS86	116	13/16 x 1-9/16	MS127	123	3/4 x 2-15/16
MS87	131	13/16 x 7/8	MS128	113	3/4 x 3/4
MS88	131	11/16 x 13/16	MS129	108	3/4 x 1-1/8
MS89	118	1-1/2 x 5	MS130	123	3/8 x 1-1/16
MS90	125	1-1/4 x 1-1/2	MS131	123	1-9/16 x 2-3/4
MS91	109	1-9/16 x 3-1/16	MS132	113	7/8 x 2
MS92	113	5/8 x 1-1/8	MS133	109	1 x 1-1/4
MS93	113	1 x 1-1/16	MS134	111	1-1/16 x 1-1/16
MS94	131	3/8 x 5/8	MS135	109	1-1/4 x 1-3/8
MS95	112	1-9/16 x 1-9/16	MS136	115	1-1/4 x 2-1/4
MS96	131	3/4 x 1-11/16	MS137	111	7/8 x 7/8
MS97	125	1-3/8 x 2-1/16	MS138	119	7/8 x 3-7/8
MS98	113	1 x 1	MS139	127	1-7/16 x 1-5/8
MS99	113	1-5/16 x 1-1/2	MS140	119	13/16 x 3
MS100	-	-	MS141	130	1-1/2 x 2-9/16
MS101	128	3/4 x 5-11/16	MS142	123	7/8 x 1-11/16
MS102	119	1-1/8 x 5-5/16	MS143	123	1-3/16 x 2-1/2
MS103	126	1-1/2 x 3	MS144	121	3/4 x 1-3/4
MS104	107	13/16 x 2-15/16	MS145	121	3/4 x 2-1/2
MS105	-	-	MS146	115	2-5/8 x 2-5/8
MS106	127	1-15/16 x 3-1/8	MS147	-	-
MS107	127	4-1/4"	MS148	117	3/4 x 2-5/8
MS108	129	1-1/4 x 7-3/8	MS149	119	1-1/8 x 2-13/16
MS109	116	1-1/4 x 3	MS150	119	1 x 3-1/4
MS110	116	1-3/8 x 3-1/16	MS151	121	3/4 x 3-1/8
MS111	128	13/16 x 4-11/16	MS152	117	1-1/16 x 2-9/16
MS112	122	1-1/16 x 1-1/16	MS153	108	1-3/8 x 4-1/4
MS113	122	1-1/2 x 1-3/4	MS154	119	7/8 x 1-13/16
MS114	122	1-1/2 x 2	MS155	116	1-1/4 x 2-7/8
MS115	122	1-1/2 x 1-7/8	MS156	124	1 x 1-11/16
MS116	115	1-3/8 x 1-3/8	MS157	121	3/4 x 2-3/16
MS117	122	1-1/4 x 3-7/16	MS158	121	3/4 x 2-3/16
MS118	108	3/4 x 1-1/2	MS159	107	3/4 x 3-1/2
MS119	125	1-3/4 x 3-1/16	MS160	129	1-1/2 x 3-1/8
MS120	108	1-1/4 x 4-1/16	MS161	131	9/16 x 1-1/8
MS121	126	1-1/8 x 3	MS162	124	2-1/2"Ø
MS122	128	1 x 2-15/16	MS163	121	1 x 1-3/4
MS123	125	2-1/16 x 3	MS164	130	1-3/8 x 2-7/16

ID#	Page #	Dimension	ID#	Page #	Dimension
MS165	130	1-5/16 x 3-3/4	MS206	126	1-3/8 x 3-1/2
MS166	130	1 x 2	MS207	126	1-9/16 x 1-15/16
MS167	121	5/8 x 11/16	MS208	126	1-5/16 x 3-1/4
MS168	130	1 x 1-1/2	MS209	123	3/4 x 3-1/8
MS169	117	1 x 4-7/16	MS210	125	1-5/8 x 5-1/2
MS170	132	1-3/8 x 4-3/8	MS211	130	3/4 x 2
MS171	117	3/4 x 5-15/16	MS212	107	3/4 x 2-1/2
MS172	117	3/4 x 3-15/16	MS213	107	3/4 x 2-1/2
MS173	124	2 x 8	MS214	116	1 x 1-1/2
MS174	109	1/4 x 1/2	MS215	-	-
MS175	117	5/8 x 3-3/8	MS216	131	3-3/8 x 4-5/16
MS176	117	3/4 x 2-3/16	MS217	131	1 x 1-1/2
MS177	110	undefined	MS218	120	5/8 x 1-3/4
MS178	107	7/8 x 2-1/2	MS219	111	1-5/8 x 3-5/8
MS179	107	undefined	MS220	120	3/4 x 3-1/4
MS180	109	11/16 x 1-5/8	MS221	119	1/2 x 1
MS181	110	1-1/2 x 5-3/8	MS222	131	5/8 x 1-3/8
MS182	-	-	MS223	-	-
MS183	122	3/4 x 1-5/8	MS224	-	-
MS184	116	1-1/2 x 3-13/16	MS225	120	13/16 x 3-1/4
MS185	108	3/4 x 3	MS226	125	1 x 3
MS186	109	5/16 x 1-9/16	MS227	129	2-9/16 x 2-5/8
MS187	111	9/16 x 1-7/16	MS228	107	13/16 x 2-1/8
MS188	126	1-1/4 x 2-1/4	MS229	107	13/16 x 2-1/4
MS189	123	3/4 x 2	MS230	107	7/8 x 2-7/8
MS190	119	3/4 x 3			
MS191	110	1-1/8 x 2-1/2			
MS192	115	1-5/8 x 2			
MS193	118	3/4 x 5-3/8			
MS194	130	3/4 x 1-1/2			
MS195	108	13/16 x 2-1/2			
MS196	107	7/8 x 2-15/16			
MS197	107	3/4 x 3			
MS198	131	1/2 x 3/4			
MS199	115	7/8 x 1-3/16			
MS200	-	-			
MS201	129	3/4 x 4-3/8			
MS202	109	2-1/4 x 2-3/8			
MS203	113	9/16 x 1-3/8			
MS204	131	3/4 x 2			
MS205	121	1/2 x 1-3/16			

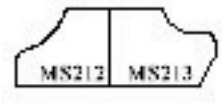

MS212 & MS213
3/4 x 2-1/2



MS196 7/8 x 2-15/16



MS178 7/8 x 2-1/2



MS197 3/4 x 3

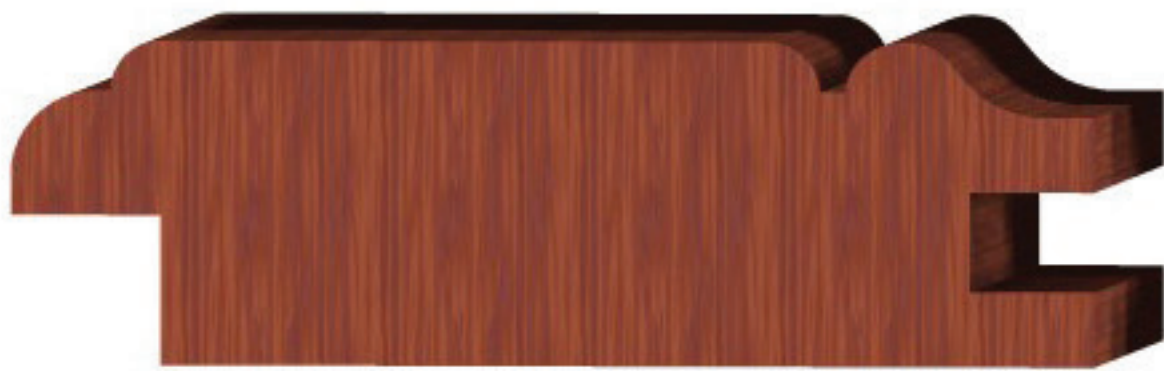

MS01 13/16 x 2-3/4



MS104 13/16 x 2-15/16

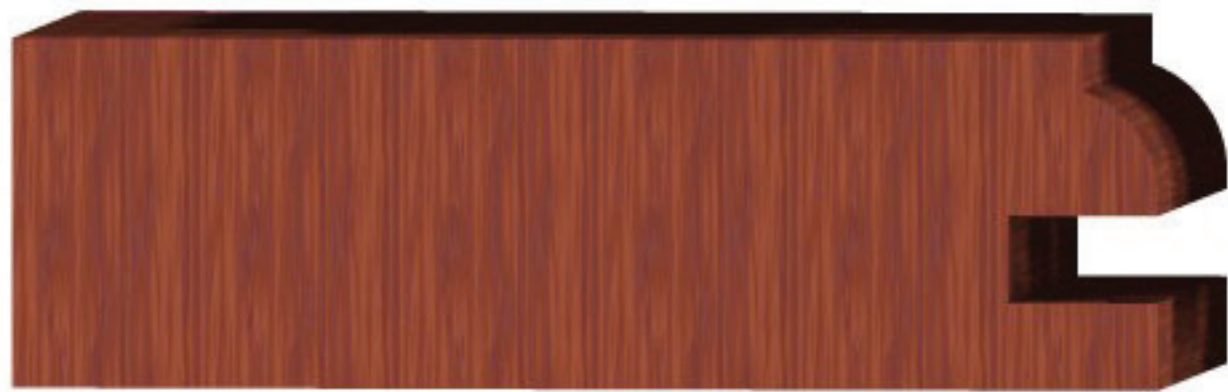

MS230 7/8 x 2-7/8



MS159 3/4 x 3-1/2



MS228 13/16 x 2-1/8



MS229 13/16 x 2-1/4



MS179



MS185 $\frac{3}{4}$ x 3



MS195 $\frac{13}{16}$ x $2\frac{1}{2}$



MS118 $\frac{3}{4}$ x $1\frac{1}{2}$



MS153 $1\frac{3}{8}$ x $4\frac{1}{4}$

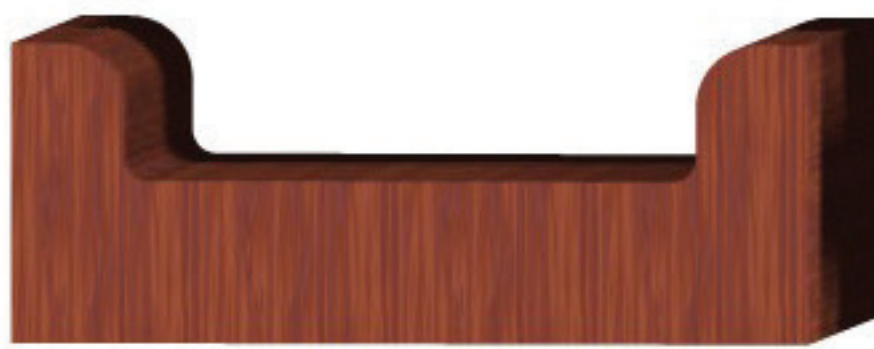

MS129 $\frac{3}{4}$ x $1\frac{1}{8}$



MS120 $1\frac{1}{4}$ x $4\frac{1}{16}$



MS72 $\frac{3}{4}$ x $2\frac{1}{16}$



MS47 $\frac{7}{8}$ x $2\frac{1}{2}$



MS35 $\frac{5}{8}$ x $5\frac{7}{16}$

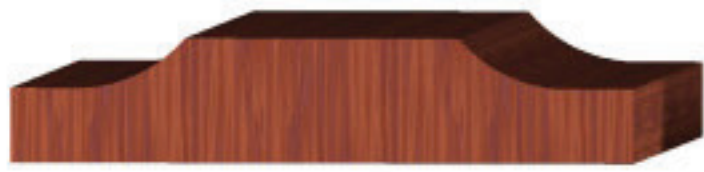

MS186 $\frac{5}{16}$ x $1\frac{9}{16}$



MS180 $\frac{11}{16}$ x $1\frac{5}{8}$



MS46 $\frac{3}{4}$ x $2\frac{1}{2}$



MS202 $2\frac{1}{4}$ x $2\frac{3}{8}$



MS85 $\frac{3}{4}$ x $2\frac{3}{8}$



MS135
 $1\frac{1}{4}$ x $1\frac{3}{8}$



MS91 $1\frac{9}{16}$ x $3\frac{1}{16}$



MS133
 1 x $1\frac{1}{4}$



MS06
 $\frac{3}{4}$ x $\frac{3}{4}$



MS174
 $\frac{1}{4}$ x $\frac{1}{2}$



MS19 $\frac{9}{16}$ x $2\frac{1}{2}$



MS45 $\frac{3}{4}$ x $1\frac{-9}{16}$



MS52 $\frac{3}{4}$ x $1\frac{-3}{4}$



MS191 $1\frac{-1}{8}$ x $2\frac{-1}{2}$



MS177



MS44 $\frac{13}{16}$ x $1\frac{-3}{4}$



MS124 $\frac{3}{4}$ x $1\frac{-9}{16}$



MS181 $1\frac{-1}{2}$ x $5\frac{-3}{8}$

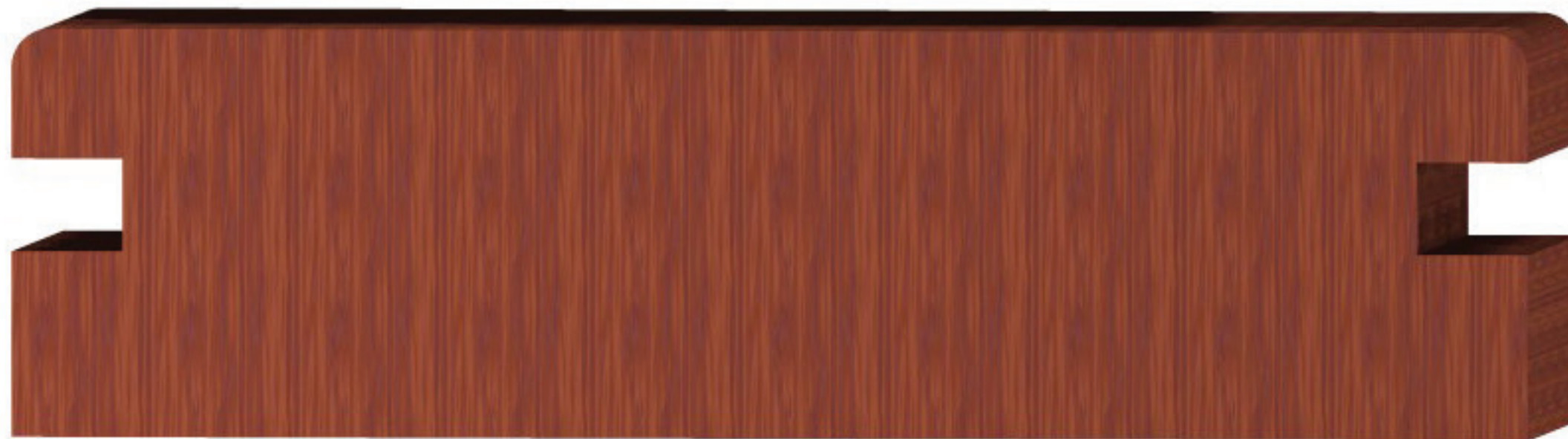

MS32 $1\frac{-7}{16}$ x $5\frac{-1}{8}$



MS125 $\frac{3}{4}$ x $1-\frac{13}{16}$



MS219
 $1-\frac{5}{8}$ x $3-\frac{5}{8}$



MS66

$\frac{1}{2}$ x $\frac{1}{2}$



MS70

$\frac{3}{8}$ x $\frac{3}{8}$



MS59 $\frac{7}{8}$ x $2-\frac{1}{16}$



MS53

$\frac{1}{2}$ x $\frac{3}{4}$



MS64

$\frac{1}{2}$ x $\frac{3}{4}$



MS63

$\frac{5}{8}$ x $\frac{5}{8}$



MS134

$1-\frac{1}{16}$ x $1-\frac{1}{16}$



MS137

$\frac{7}{8}$ x $\frac{7}{8}$



MS65

$\frac{3}{4}$ x $\frac{3}{4}$



MS68 $\frac{3}{4}$ x $1-\frac{7}{8}$



MS187 $\frac{9}{16}$ x $1-\frac{7}{16}$



MS42 1-3/8 x 4-1/8



MS43 3/4 x 1-1/4



MS04 1-3/8 x 4-1/8



MS03 3/4 x 1-3/4



MS29 1-1/4 x 3-13/16



MS58 2-1/2 x 2-1/2



MS60 1-3/4 x 1-3/4



MS95 1-9/16 x 1-9/16



MS79 $1\text{-}\frac{3}{16}$ x $1\text{-}\frac{5}{16}$



MS203 $\frac{9}{16}$ x $1\text{-}\frac{3}{8}$



MS27 $1\text{-}\frac{9}{16}$ x $2\text{-}\frac{1}{16}$



MS92 $\frac{5}{8}$ x $1\text{-}\frac{1}{8}$



MS93
 1 x $1\text{-}\frac{1}{16}$



MS41 $1\text{-}\frac{1}{4}$ x $1\text{-}\frac{1}{2}$



MS128 $\frac{3}{4}$ x $\frac{3}{4}$



MS98
 1 x 1

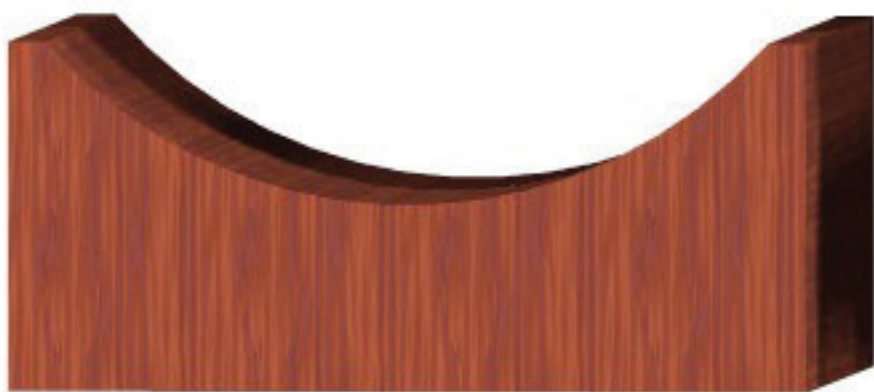

MS132 $\frac{7}{8}$ x 2



MS99 $1\text{-}\frac{5}{16}$ x $1\text{-}\frac{1}{2}$



MS40 $1\text{-}\frac{15}{16}$ x $2\text{-}\frac{1}{8}$



MS67
7/16 x 15/16

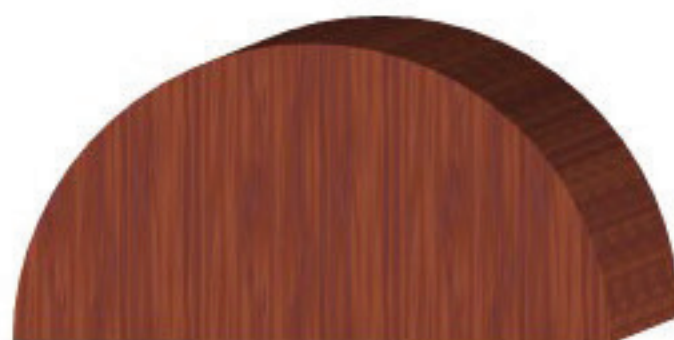

MS61 3/4 x 1-1/2



MS17 1-3/4 x 2-7/16



MS57 2 x 4



MS08
1-1/8 x 1-1/8



MS146 2-5/8 x 2-5/8



MS116
1-3/8 x 1-3/8



MS192 1-5/8 x 2



MS136 1-1/4 x 2-1/4



MS199
7/8 x 1-3/16



MS05
1-1/8 x 1-1/8



MS07
3/4 x 3/4



MS214 1 x 1-1/2



MS31 15/16 x 1



MS155 1-1/4 x 2-7/8

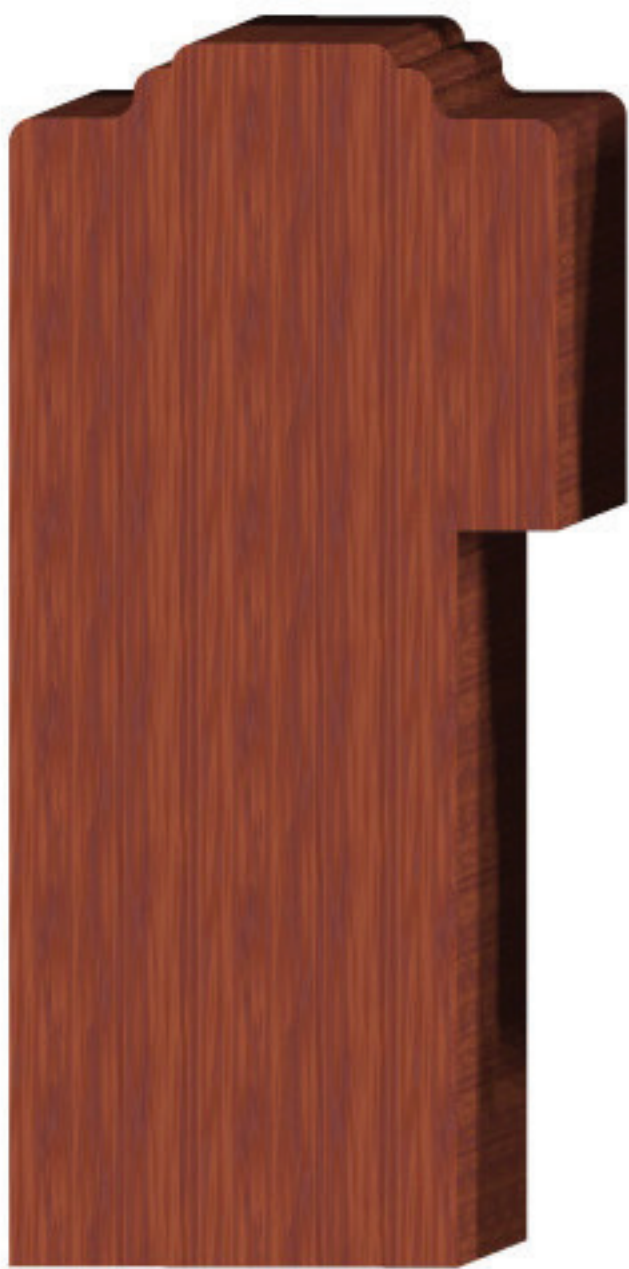

MS110 1-3/8 x 3-1/16

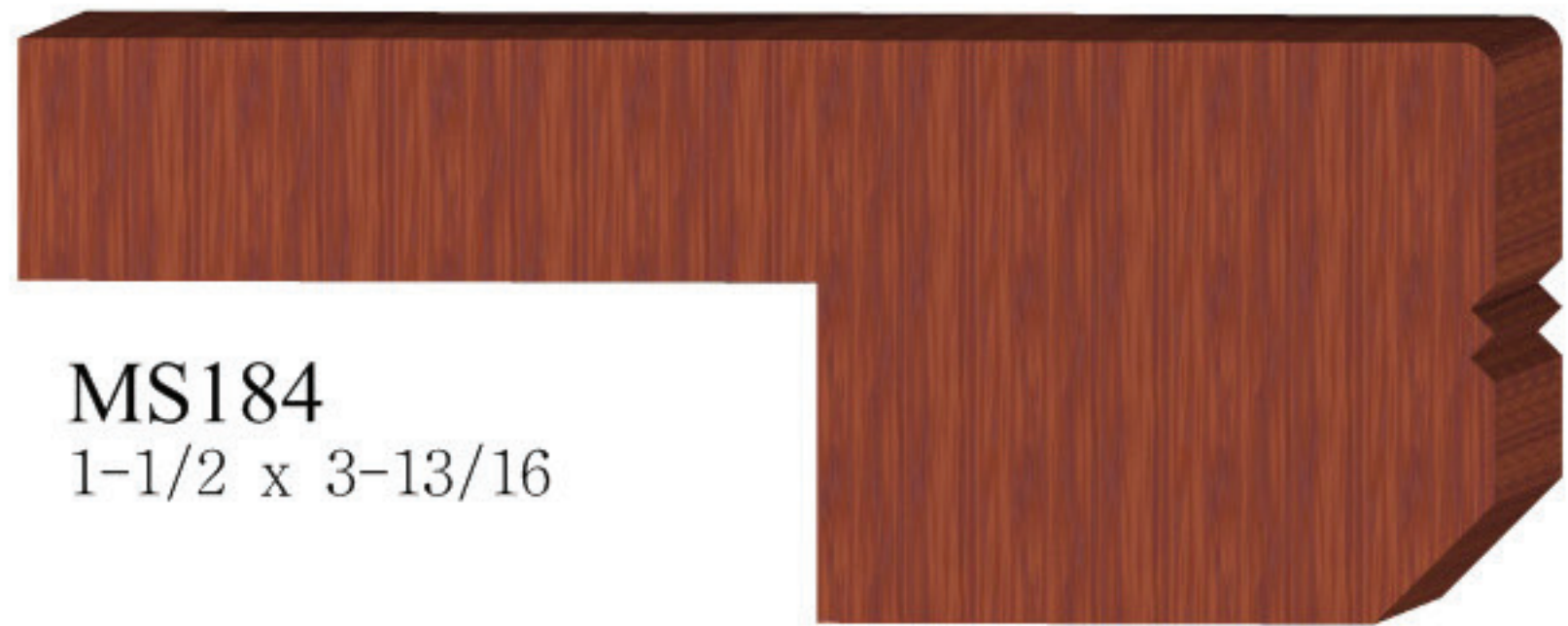

MS184
1-1/2 x 3-13/16



MS109 1-1/4 x 3



MS86
13/16 x 1-9/16



MS24
1-1/4 x 1-7/8



MS15
1 x 1-7/16



MS176 $\frac{3}{4}$ x $2\frac{3}{16}$



MS175 $\frac{5}{8}$ x $3\frac{3}{8}$

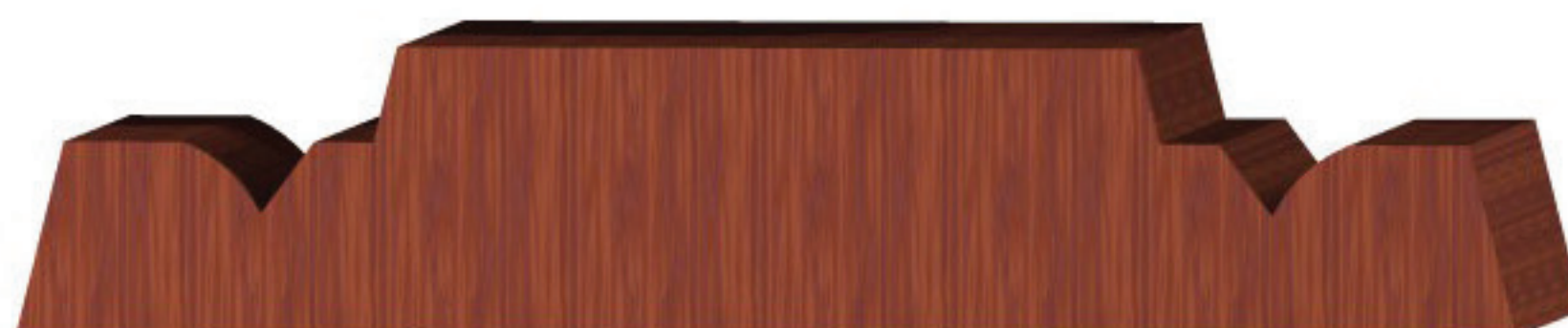

MS172 $\frac{3}{4}$ x $3\frac{15}{16}$

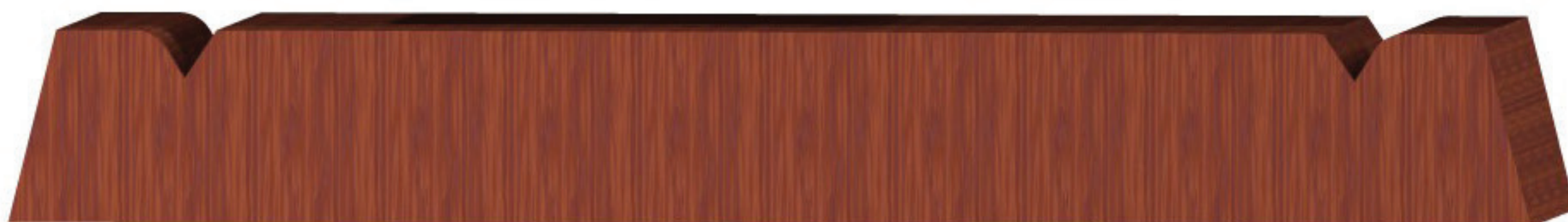

MS171 $\frac{3}{4}$ x $5\frac{15}{16}$



MS169 1 x $4\frac{7}{16}$



MS152 $1\frac{1}{16}$ x $2\frac{9}{16}$



MS148 $\frac{3}{4}$ x $2\frac{5}{8}$



MS30 $\frac{3}{4}$ x $4\text{-}\frac{3}{16}$

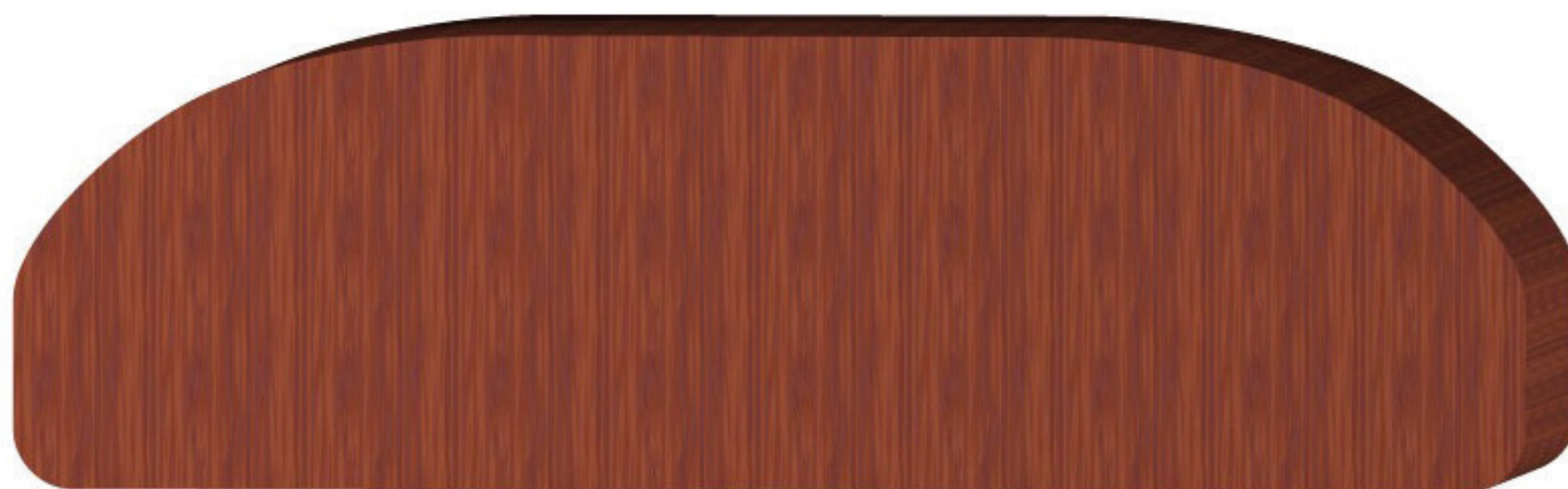

MS89 $1\text{-}\frac{1}{2}$ x 5



MS33 $\frac{11}{16}$ x $4\text{-}\frac{1}{2}$ to $7\text{-}\frac{1}{4}$



MS193 $\frac{3}{4}$ x $5\text{-}\frac{3}{8}$



MS50 $\frac{3}{4}$ x $5\text{-}\frac{7}{16}$



MS13 $\frac{13}{16}$ x $3-\frac{1}{16}$



MS221 $\frac{1}{2}$ x 1



MS150 1 x $3-\frac{1}{4}$

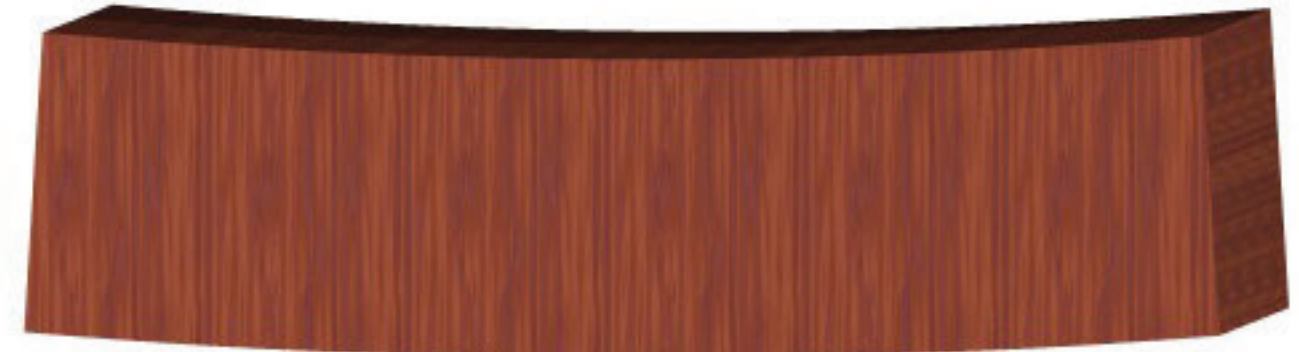

MS140 $\frac{13}{16}$ x 3



MS149 $1-\frac{1}{8}$ x $2-\frac{13}{16}$



MS190 $\frac{3}{4}$ x 3

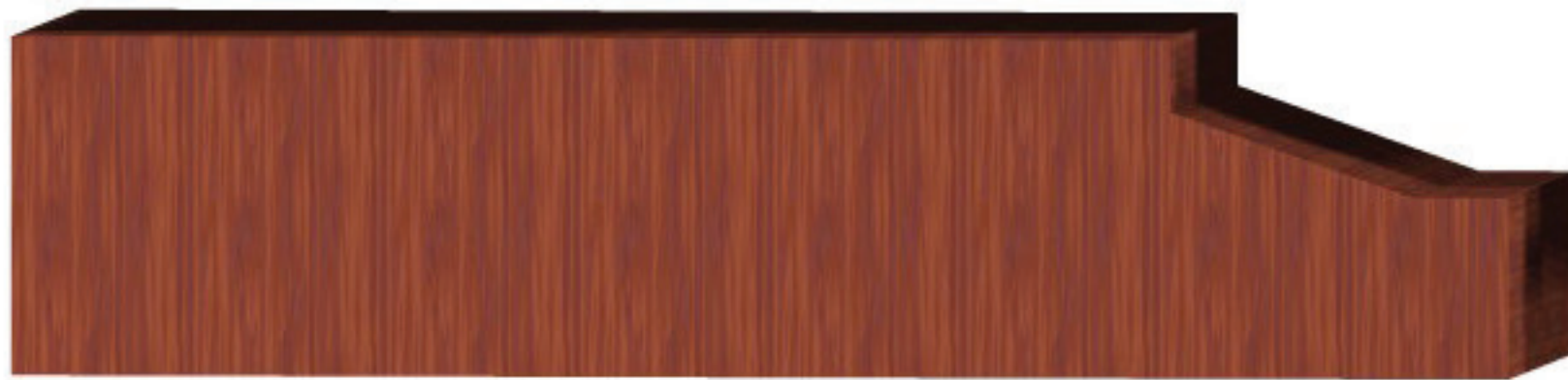

MS138 $\frac{7}{8}$ x $3-\frac{7}{8}$



MS154 $\frac{7}{8}$ x $1-\frac{13}{16}$



MS102 $1-\frac{1}{8}$ x $5-\frac{5}{16}$



MS21 $\frac{5}{8}$ x $3\frac{7}{8}$



MS20 $\frac{3}{4}$ x $3\frac{3}{4}$



MS218 $\frac{5}{8}$ x $1\frac{3}{4}$

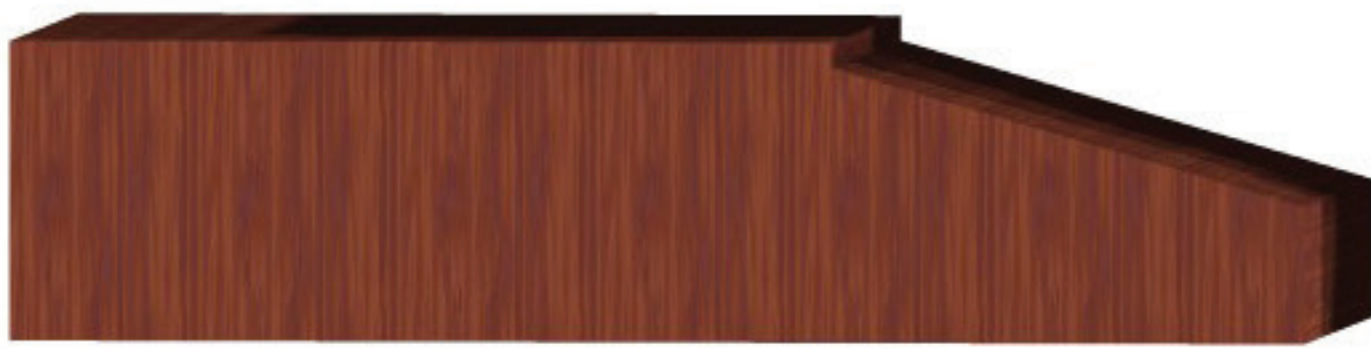

MS49 $\frac{3}{4}$ x $3\frac{1}{4}$



MS09 $\frac{15}{16}$ x $3\frac{1}{16}$



MS220 $\frac{3}{4}$ x $3\frac{1}{4}$

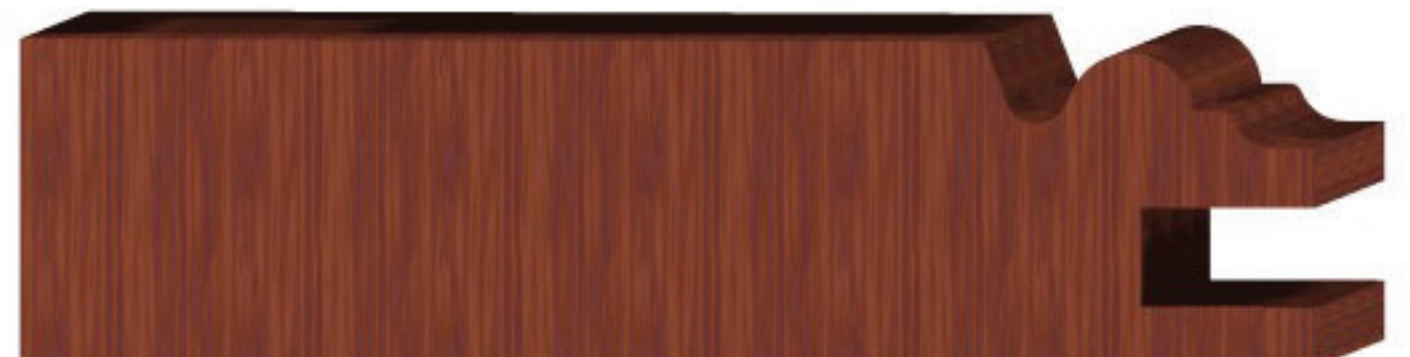

MS225 $\frac{13}{16}$ x $3\frac{1}{4}$

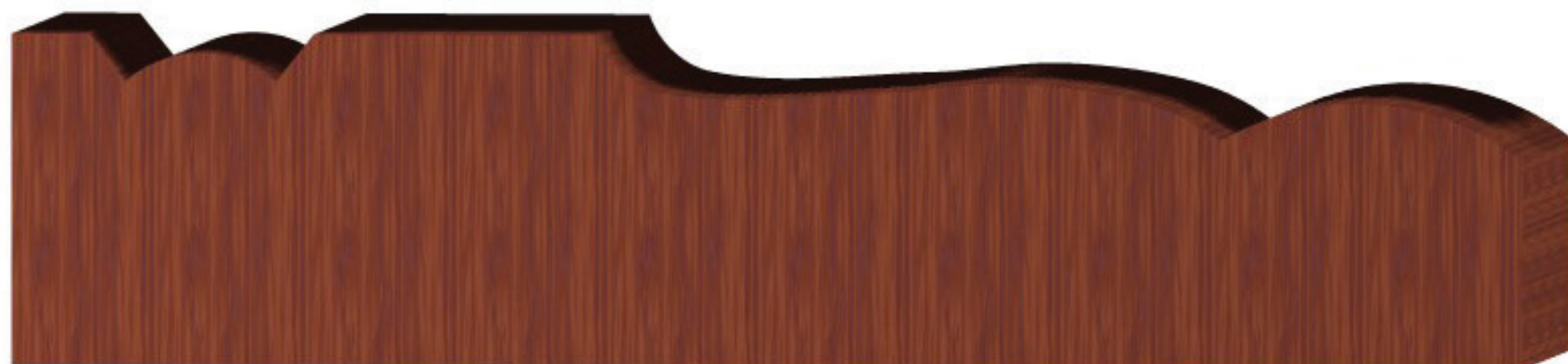

MS18 $1\frac{1}{8}$ x 5



MS205 1/2 x 1-3/16



MS157 3/4 x 2-3/16



MS158 3/4 x 2-3/16



MS163
1 x 1-3/4



MS167
5/8 x 11/16



MS75
3/4 x 3/4

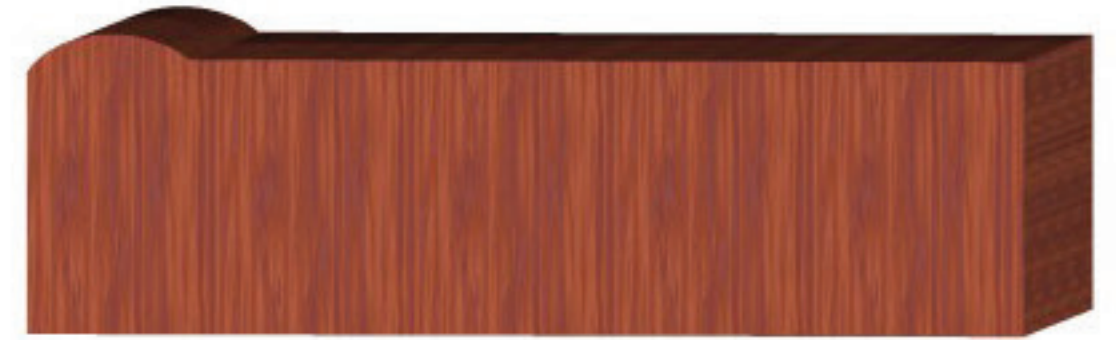

MS145
3/4 x 2-1/2



MS77 9/16 x 1-1/2



MS84 5/8 x 1-1/4

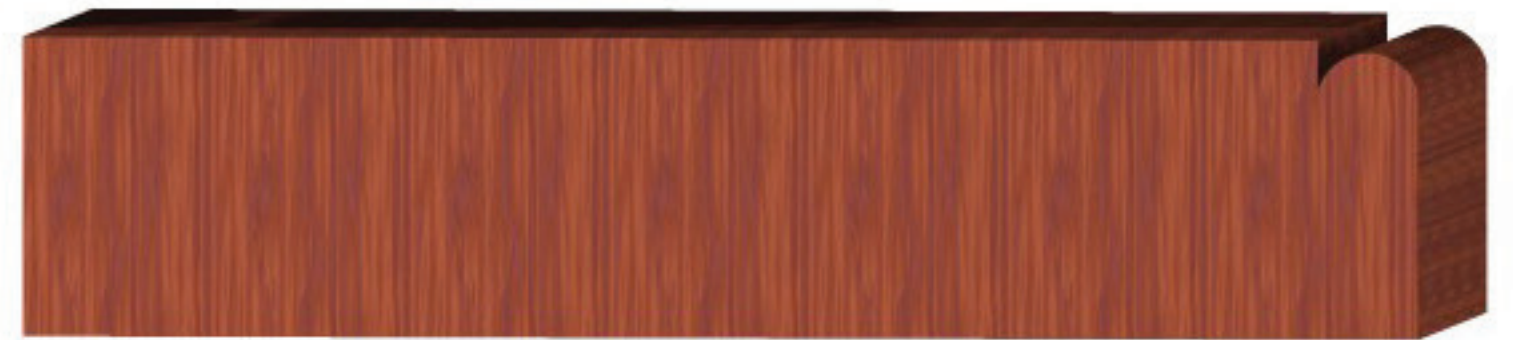

MS26 3/4 x 3-1/2



MS69 3/4 x 1-5/16

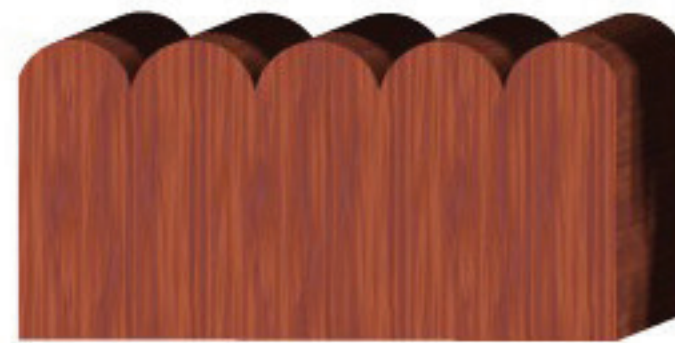

MS126 3/4 x 1-1/2



MS71 3/4 x 1-5/8



MS144 3/4 x 1-3/4



MS11 5/8 x 1-5/8



MS151 3/4 x 3-1/8



MS14
1/2 x 7/8



MS16
5/16 x 11/16



MS02
3/8 x 1



MS74
3/16 x 11/16



MS56
1/4 x 1



MS117 1-1/4 x 3-7/16

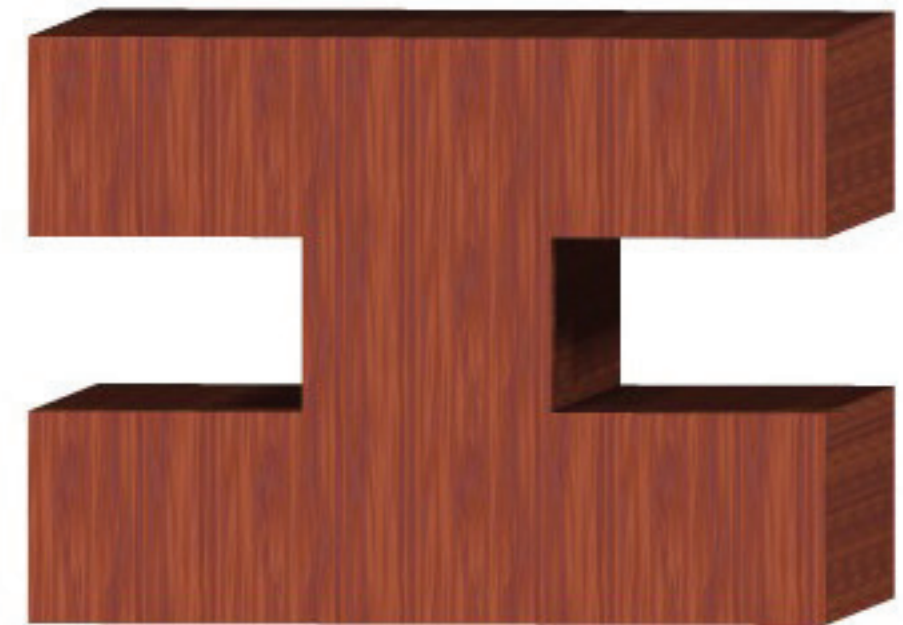

MS114 1-1/2 x 2

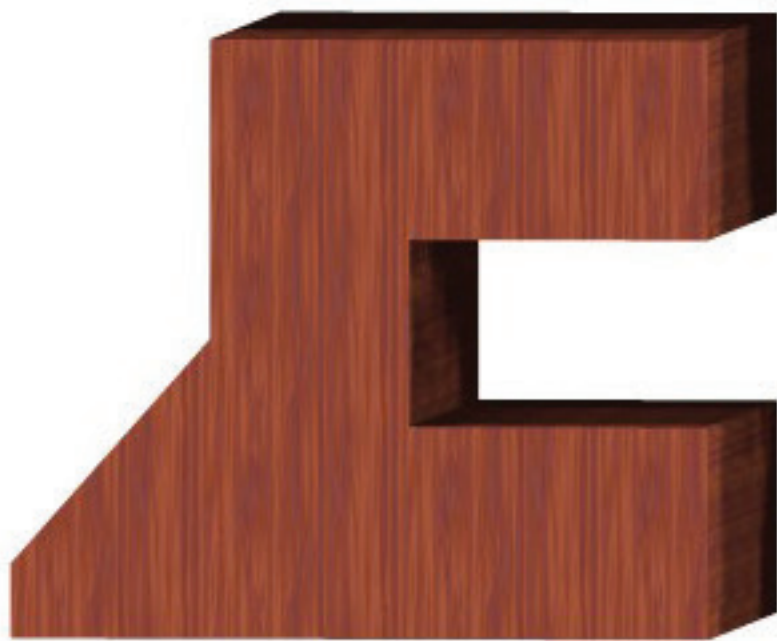

MS113
1-1/2 x 1-3/4



MS112
1-1/16 x 1-1/16



MS115
1-1/2 x 1-7/8



MS36 3/4 x 2-3/8

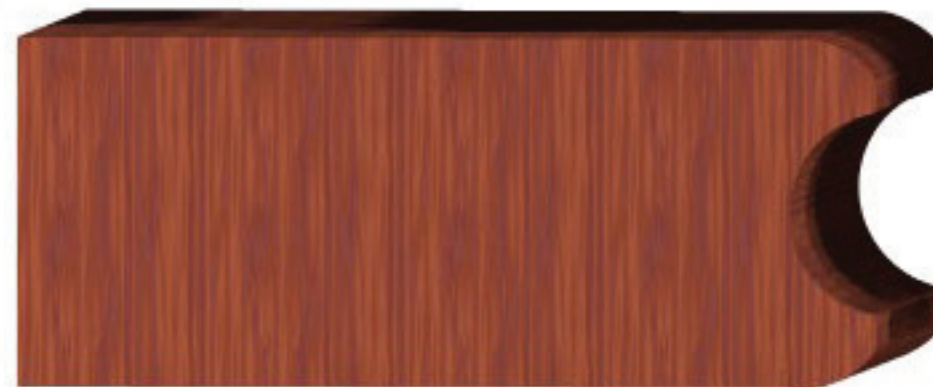

MS38 7/8 x 2-3/16



MS183 3/4 x 1-5/8



MS73 11/16 x 3-5/16

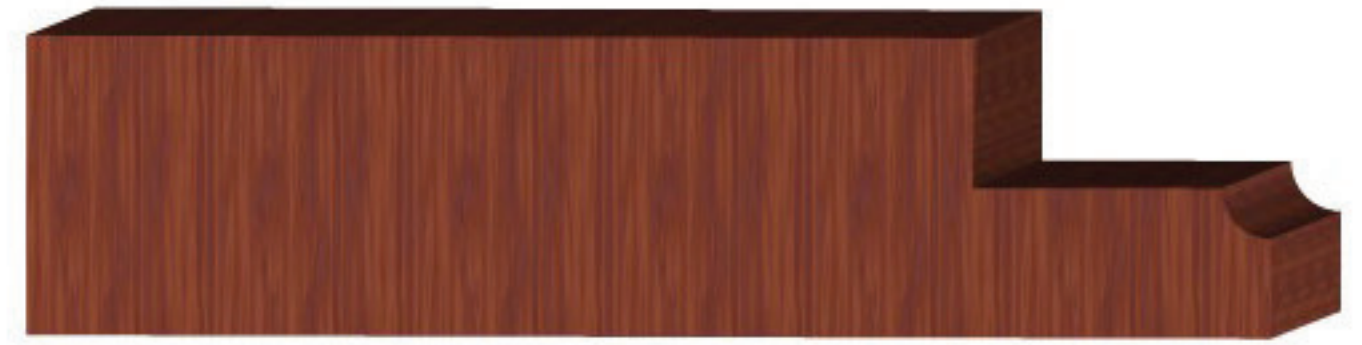

MS209 3/4 x 3-1/8



MS127 3/4 x 2-15/16



MS130 3/8 x 1-1/16



MS142 7/8 x 1-11/16



MS143 1-3/16 x 2-1/2



MS131 1-9/16 x 2-3/4



MS22 3/4 x 3-1/4

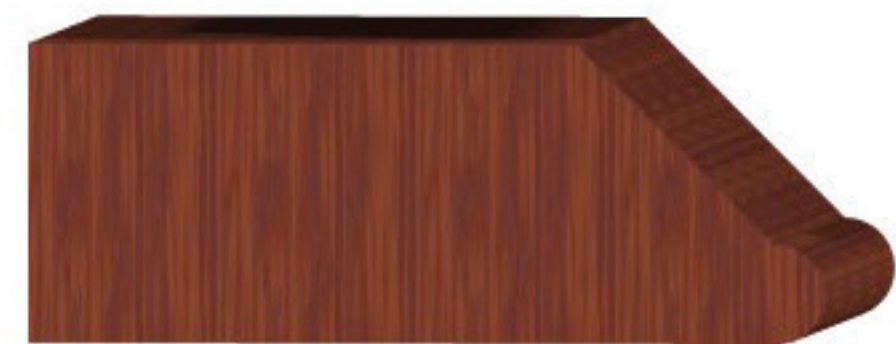

MS189 3/4 x 2



MS25 1 x 5-3/4

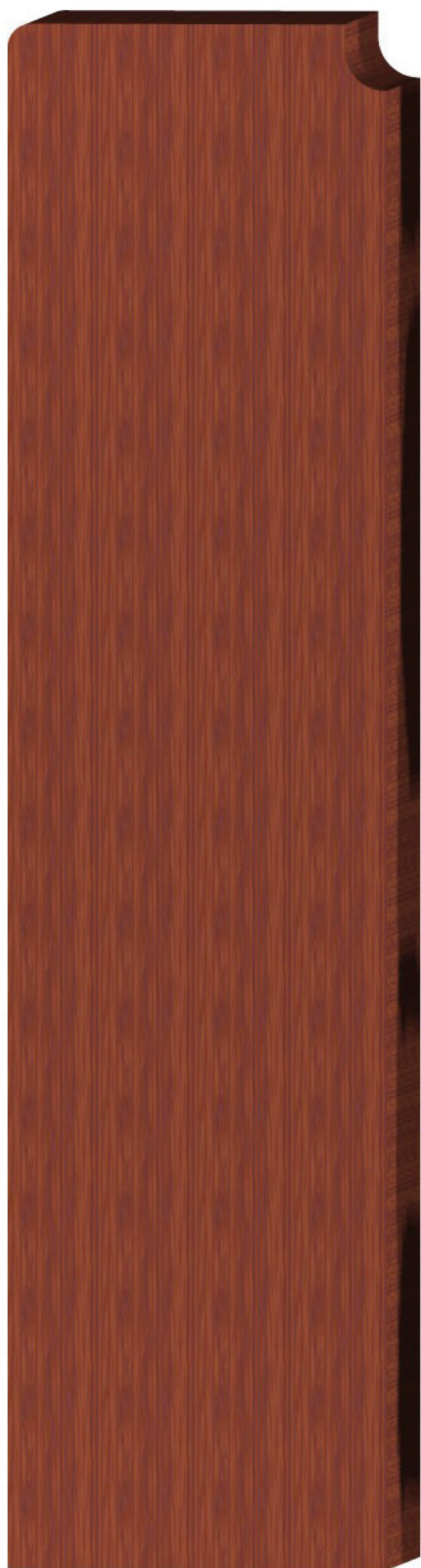

MS173 2 x 8

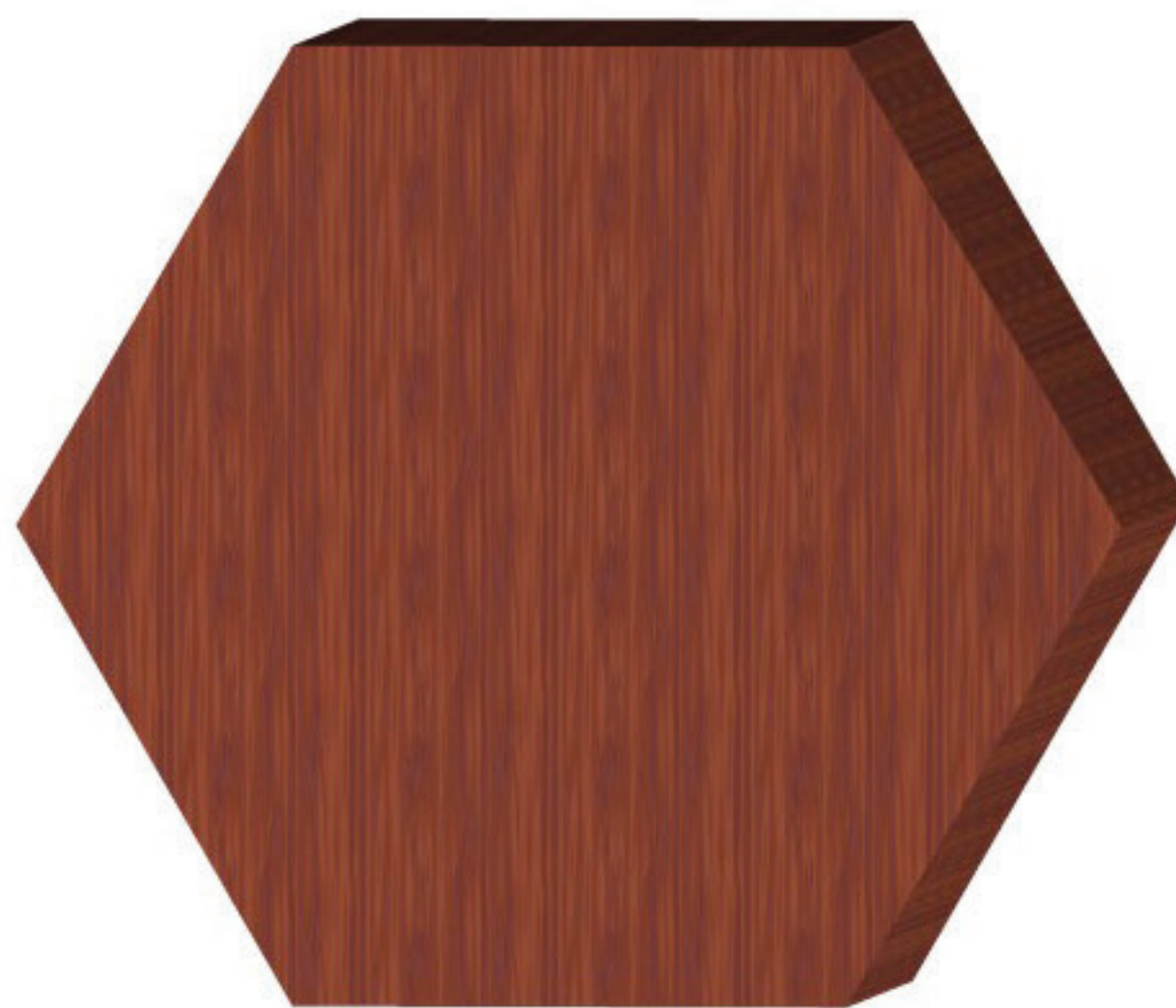

MS39 2-7/8



MS162 2-1/2



MS156 1 x 1-11/16



MS210 1-5/8 x 5-1/2



MS226 1 x 3



MS90 1-1/4 x 1-1/2

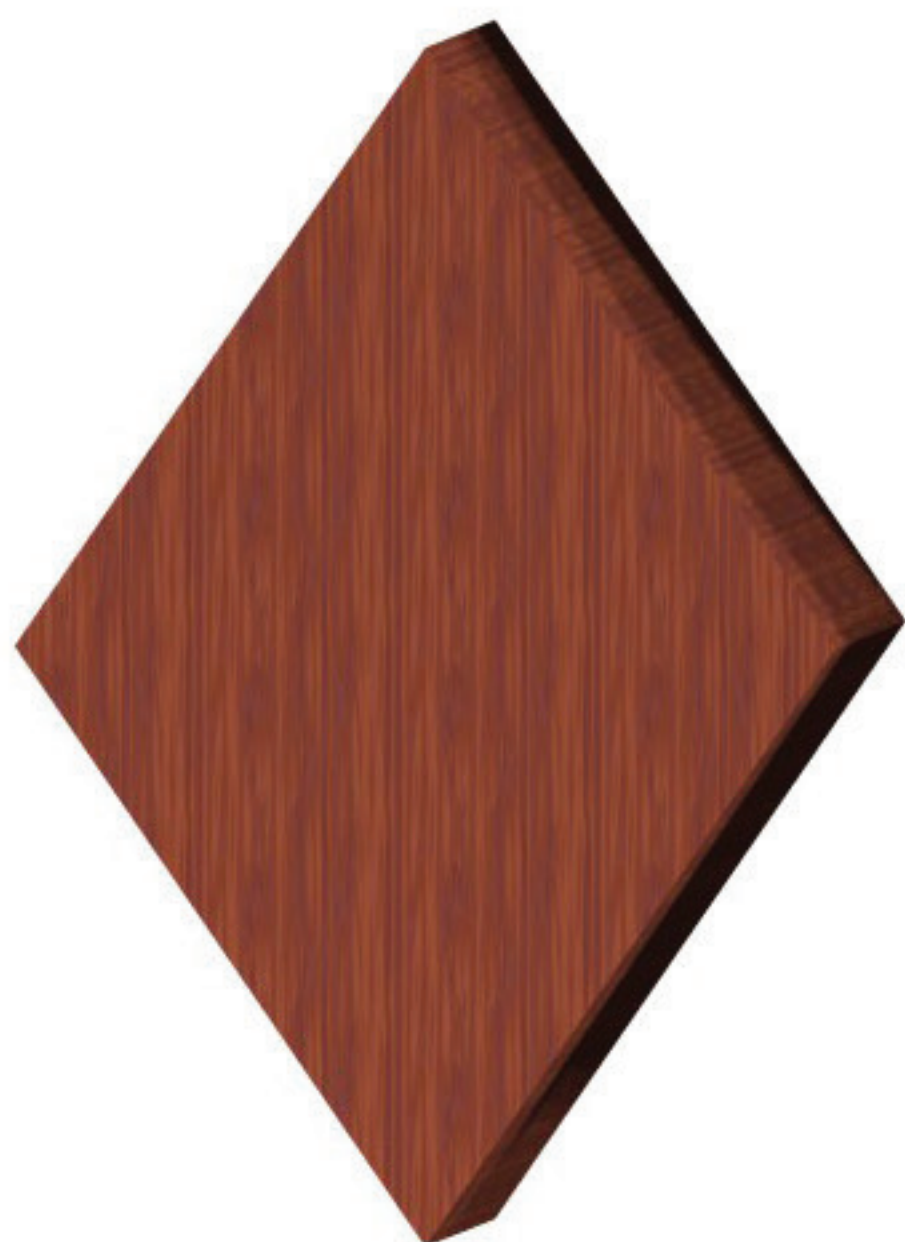

MS123 2-1/16 x 3



MS97 1-3/8 x 2-1/16



MS119 1-3/4 x 3-1/16



MS121 1-1/8 x 3



MS103 1-1/2 x 3

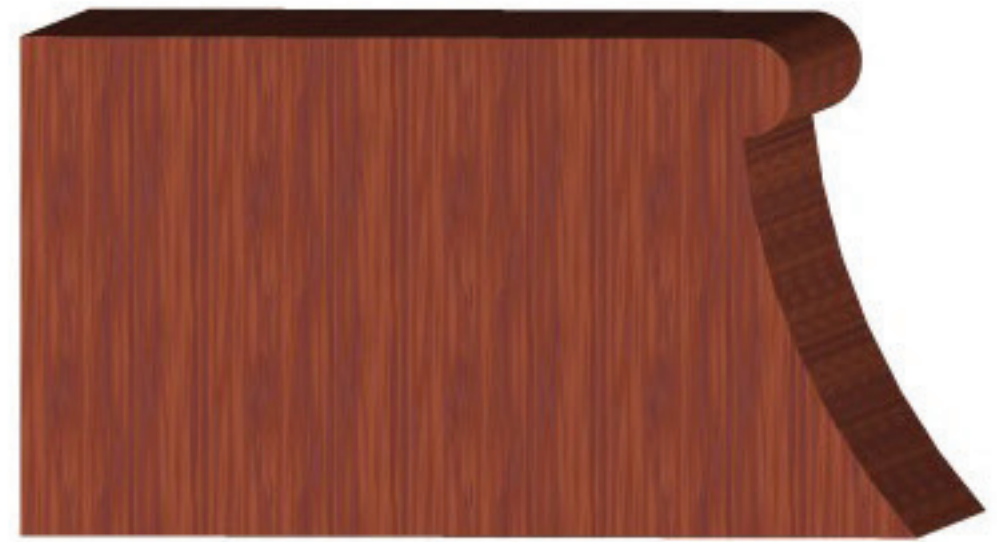

MS188 1-1/4 x 2-1/4

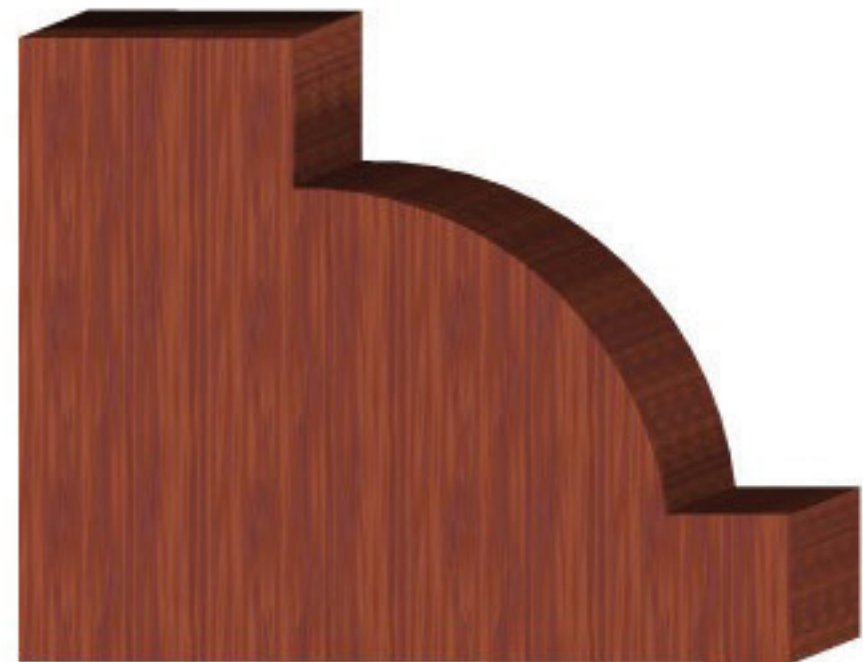

MS207 1-9/16 x 1-15/16



MS208 1-5/16 x 3-1/4



MS206 1-3/8 x 3-1/2

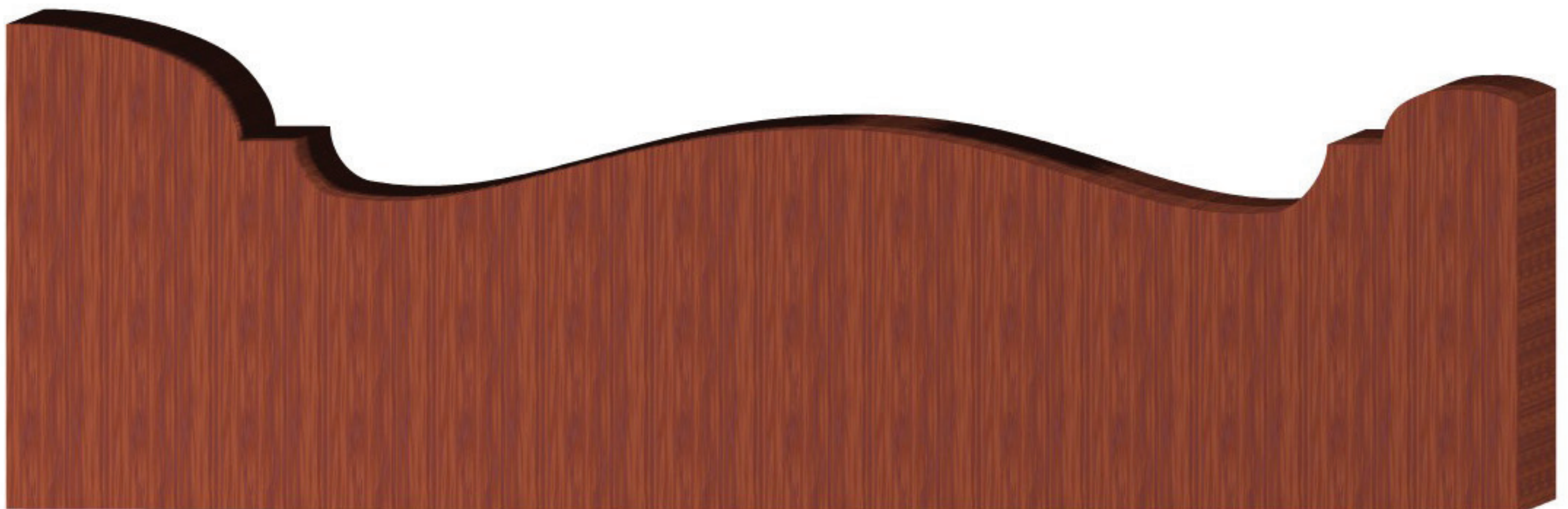

MS28 2-1/2 x 7

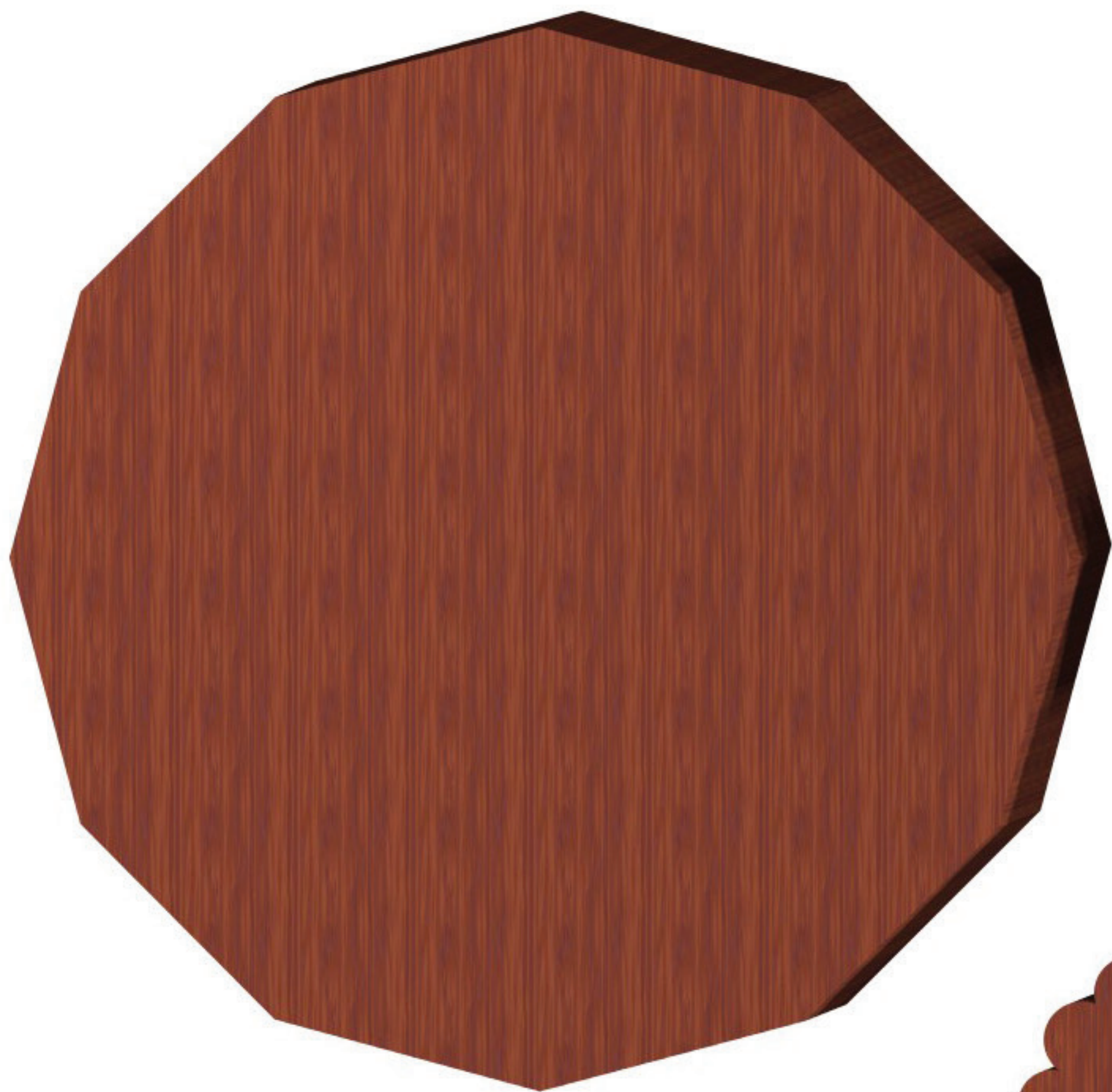

MS107 4-1/4



MS139 1-7/16 x 1-5/8



MS106 1-15/16 x 3-1/8

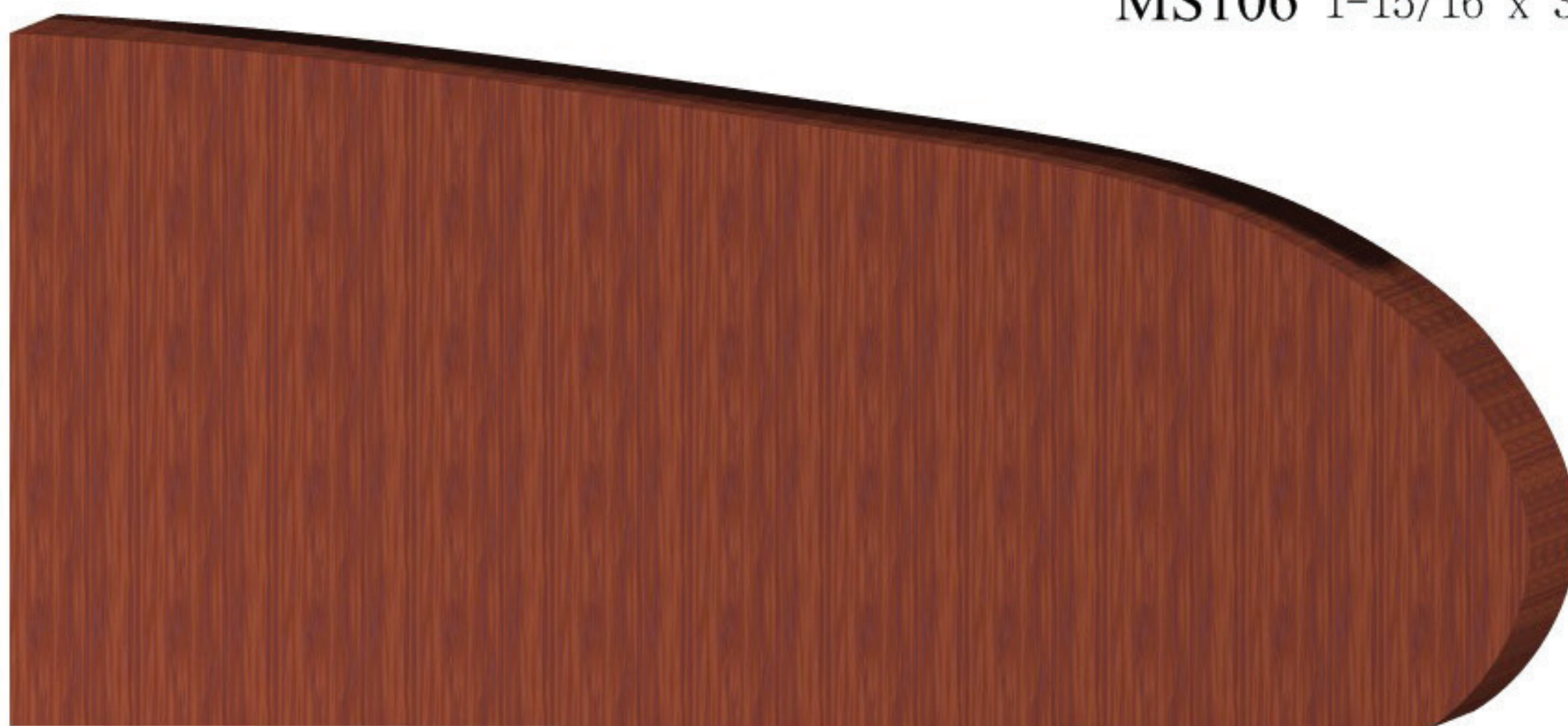

MS34 2-1/2 x 5-1/2



MS111 $1\frac{3}{16}$ x $4\frac{11}{16}$



MS23 $1\frac{3}{16}$ x $4\frac{1}{2}$



MS10 $1\frac{1}{8}$ x $2\frac{1}{2}$



MS48 $\frac{5}{8}$ x $3\frac{5}{8}$



MS122 1 x $2\frac{15}{16}$



MS51 $1\frac{1}{16}$ x $5\frac{11}{16}$



MS101 $\frac{3}{4}$ x $5\frac{11}{16}$



MS108
1-1/4 x 7-3/8



MS227 2-9/16 x 2-5/8



MS160 1-1/2 x 3-1/8

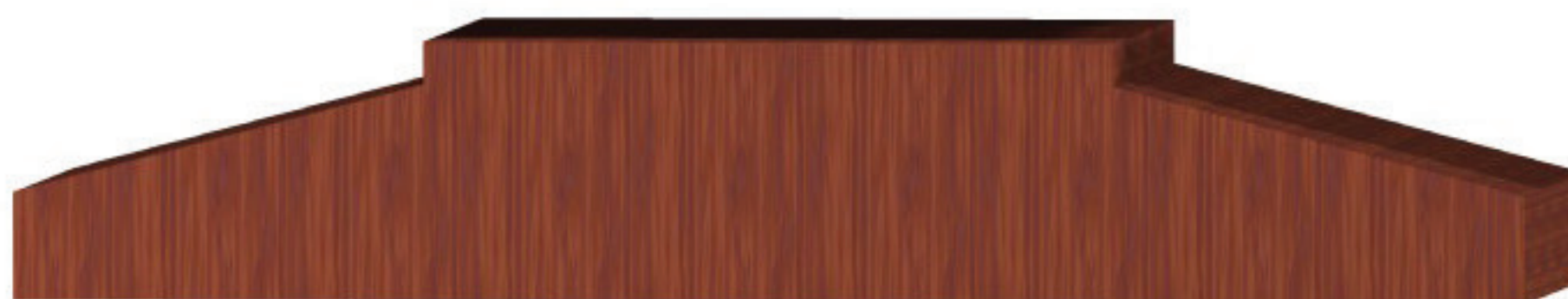

MS201 3/4 x 4-3/8



MS194 $\frac{3}{4}$ x $1\frac{1}{2}$



MS168 1 x $1\frac{1}{2}$



MS211 $\frac{3}{4}$ x 2



MS164 $1\frac{3}{8}$ x $2\frac{7}{16}$



MS166 1 x 2

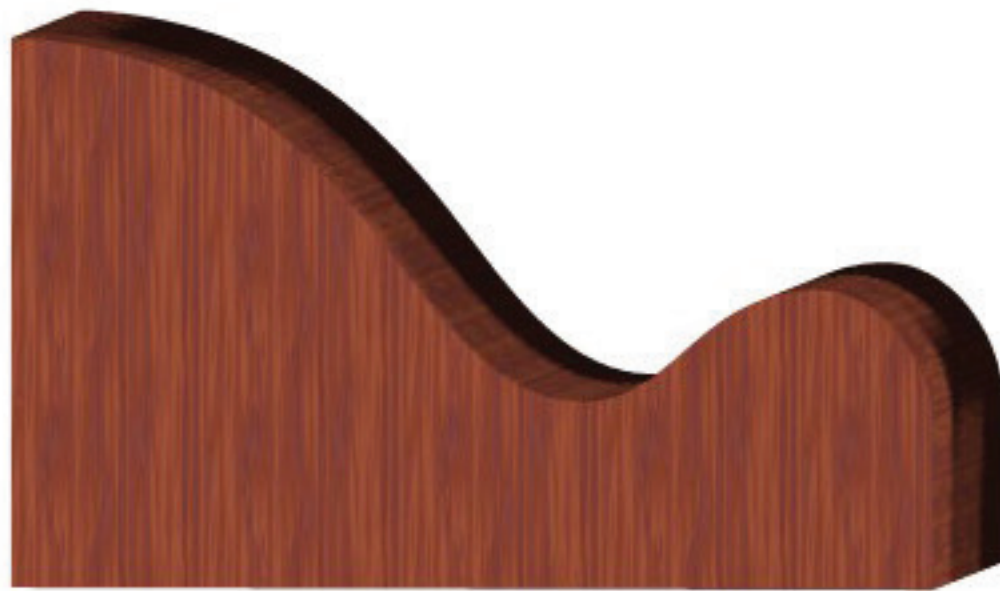

MS80 $1\frac{3}{8}$ x $2\frac{5}{16}$



MS81 $1\frac{3}{4}$ x $2\frac{3}{16}$



MS141 $1\frac{1}{2}$ x $2\frac{9}{16}$



MS165 $1\frac{5}{16}$ x $3\frac{3}{4}$



MS94
3/8 x 5/8



MS198
1/2 x 3/4



MS222
5/8 x 1-3/8



MS88
11/16 x 13/16



MS87
13/16 x 7/8



MS83
5/8 x 1-5/16



MS161
9/16 x 1-1/8



MS82
1/2 x 15/16



MS54
1/2 x 13/16



MS55
3/4 x 3/4



MS217
1 x 1-1/2



MS96 3/4 x 1-11/16



MS204 3/4 x 2

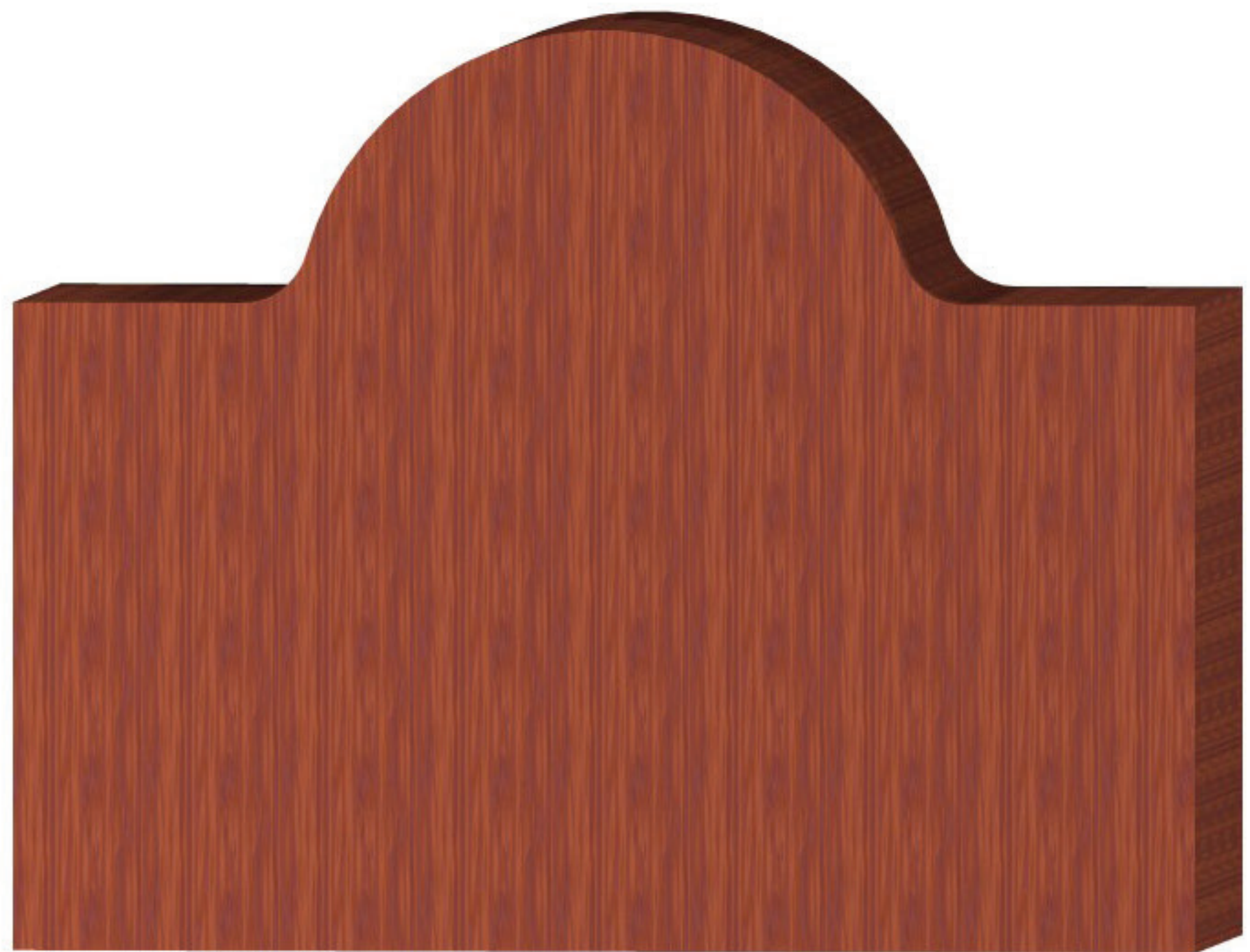

MS216 3-3/8 x 4-5/16

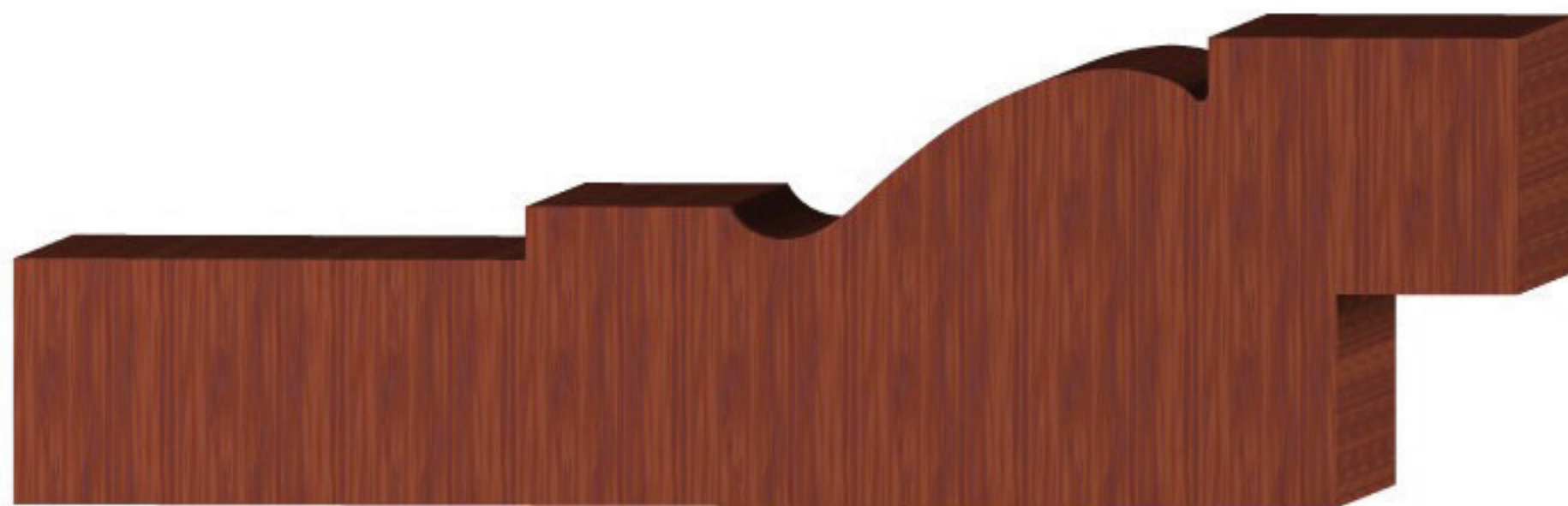

MS170
1-3/8 x 4-3/8

PLANTON



ID#	Page #	Dimension	ID#	Page #	Dimension
PO01	135	1/2 x 3/4	PO42	138	3/4 x 1-11/16
PO02	145	5/16 x 1-1/16	PO43	137	7/8 x 1-7/16
PO03	145	3/8 x 3/4	PO44	145	1 x 2-1/16
PO04	145	11/16 x 1-3/4	PO45	137	5/8 x 1-3/8
PO05	135	1/4 x 3/4	PO46	137	1-1/16 x 1-5/8
PO06	145	1/8 x 1-1/4	PO47	141	3/4 x 1-11/16
PO07	145	7/16 x 3/4	PO48	136	13/16 x 2-1/8
PO08	140	3/8 x 11/16	PO49	142	7/16 x 1-7/16
PO09	135	9/16 x 11/16	PO50	142	1-3/8 x 2-1/2
PO10	139	1-1/4 x 1-3/4	PO51	145	1/2 x 1-1/4
PO11	138	1-11/16 x 5-1/16	PO52	138	1-1/16 x 2-9/16
PO12	145	11/16 x 1-1/2	PO53	140	11/16 x 1-13/16
PO13	145	1/2 x 1-1/2	PO54	140	1-1/4 x 2-5/16
PO14	145	3/4 x 1-1/2	PO55	138	11/16 x 1-13/16
PO15	139	1-1/16 x 1-7/16	PO56	140	1-1/8 x 1-7/8
PO16	143	7/8 x 1-7/8	PO57	138	1-3/8 x 2-11/16
PO17	136	11/16 x 2-1/2	PO58	140	3/4 x 2
PO18	136	3/4 x 1-3/4	PO59	138	1-13/16 x 3-1/8
PO19	135	11/16 x 1-3/8	PO60	140	3/4 x 1-5/8
PO20	136	7/8 x 1-3/8	PO61	135	7/16 x 7/8
PO21	142	15/16 x 2	PO62	137	9/16 x 1-3/16
PO22	135	13/16 x 2-1/4	PO63	140	7/16 x 13/16
PO23	136	3/4 x 2-15/16	PO64	140	1/2 x 13/16
PO24	143	1/2 x 1-1/2	PO65	137	3/4 x 1-3/4
PO25	135	11/16 x 1-1/8	PO66	145	3/4 x 1-7/8
PO26	135	3/4 x 7/8	PO67	135	1/2 x 13/16
PO27	135	11/16 x 1-5/8	PO68	138	5/8 x 1-5/8
PO28	140	3/4 x 7/8	PO69	138	15/16 x 1-1/2
PO29	144	1 x 1	PO70	145	3/8 x 3/4
PO30	137	1 x 3-1/16	PO71	140	13/16 x 1-3/8
PO31	135	1/2 x 3/4	PO72	142	13/16 x 2-1/4
PO32	143	9/16 x 1-5/8	PO73	143	9/16 x 1-7/16
PO33	141	1-3/8 x 3-15/16	PO74	-	-
PO34	143	3/4 x 1-7/8	PO75	141	1-3/4 x 3-7/8
PO35	135	1/2 x 13/16	PO76	135	7/8 x 2-1/4
PO36	139	1-1/16 x 1-5/8	PO77	136	11/16 x 2
PO37	135	11/16 x 1-3/4	PO78	136	1-1/8 x 4-1/4
PO38	137	13/16 x 3	PO79	143	3/4 x 1-3/4
PO39	145	1/2 x 1-1/16	PO80	135	1/2 x 1-5/16
PO40	135	3/4 x 1-5/16	PO81	143	3/4 x 2-1/2
PO41	142	1-1/4 x 2	PO82	143	3/4 x 3-1/2

ID#	Page #	Dimension	ID#	Page #	Dimension
PO83	145	1 x 2-5/16	PO124	142	2-11/16 x 2-3/4
PO84	137	1/2 x 15/16	PO125	142	1-1/4 x 1-1/2
PO85	136	7/8 x 1-3/4	PO126	143	5/8 x 7/8
PO86	141	1-9/16 x 5-3/16	PO127	136	13/16 x 1-1/8
PO87	141	1-3/8 x 3-1/2	PO128	136	13/16 x 1-11/16
PO88	135	9/16 x 1-5/16	PO129	139	1-1/4 x 1-1/2
PO89	143	3/4 x 2	PO130	144	9/16 x 7/8
PO90	140	15/16 x 1-5/16	PO131	135	1/2 x 1-3/4
PO91	139	1-7/16 x 2-3/8	PO132	143	1-3/16 x 2-7/16
PO92	143	3/4 x 1-9/16	PO133	140	13/16 x 1-1/2
PO93	137	3/4 x 1-15/16	PO134	137	5/16 x 3/4
PO94	135	1/2 x 1-3/8	PO135	135	9/16 x 7/8
PO95	145	7/16 x 1-1/8	PO136	140	3/4 x 1-5/16
PO96	145	3/8 x 3/4	PO137	135	5/8 x 1-7/8
PO97	143	3/4 x 2-7/16	PO138	140	13/16 x 1-1/8
PO98	145	9/16 x 15/16	PO139	136	13/16 x 1-1/2
PO99	136	13/16 x 1-1/2	PO140	140	1-1/16 x 1-1/2
PO100	143	3/8 x 3/4	PO141	137	11/16 x 1-5/8
PO101	137	15/16 x 1-5/16	PO142	139	1-1/16 x 2-1/16
PO102	137	5/8 x 2	PO143	144	3/8 x 1-3/16
PO103	137	7/16 x 1-1/16	PO144	144	13/16 x 1-5/8
PO104	135	9/16 x 1-1/2	PO145	144	1-1/8 x 2-1/8
PO105	143	5/8 x 1-7/16	PO146	144	1-1/8 x 2-5/16
PO106	135	3/4 x 1-3/4	PO147	144	5/8 x 1-3/16
PO107	145	3/4 x 1-3/4	PO148	144	11/16 x 2-1/4
PO108	137	7/8 x 1-7/8	PO149	135	3/4 x 1-5/16
PO109	139	1-1/2 x 2-9/16	PO150	144	1-1/4 x 2
PO110	139	13/16 x 1-9/16	PO151	144	3/4 x 1-1/8
PO111	142	2 x 4	PO152	138	9/16 x 1-1/16
PO112	135	5/8 x 1-1/4	PO153	144	15/16 x 1-1/8
PO113	136	1 x 2-1/16	PO154	144	7/8 x 1-3/16
PO114	140	5/8 x 1-11/16	PO155	144	5/8 x 15/16
PO115	140	9/16 x 1-1/8	PO156	144	1/2 x 1-1/2
PO116	139	7/8 x 1-1/8	PO157	144	5/8 x 13/16
PO117	140	1-1/8 x 2-1/16	PO158	145	5/8 x 1-7/16
PO118	139	1 x 1-3/16	PO159	141	3/4 x 7/8
PO119	139	1-1/2 x 2-1/2	PO160	139	1 x 1-1/2
PO120	145	3/4 x 1-7/16	PO161	144	1/2 x 7/8
PO121	139	7/8 x 1-5/16			
PO122	141	1-7/16 x 2-7/16			
PO123	141	1 x 1-13/16			



PO27
11/16 x 1-5/8



PO106
3/4 x 1-3/4



PO94
1/2 x 1-3/8



PO61
7/16 x 7/8



PO40
3/4 x 1-5/16



PO26
3/4 x 7/8



PO09
9/16 x 11/16



PO35
1/2 x 13/16



PO67
1/2 x 13/16



PO19
11/16 x 1-3/8



PO25
11/16 x 1-1/8



PO88
9/16 x 1-5/16



PO01
1/2 x 3/4



PO05
1/4 x 3/4



PO37
11/16 x 1-3/4



PO137
5/8 x 1-7/8



PO135
9/16 x 7/8



PO31
1/2 x 3/4



PO131
1/2 x 1-3/4



PO112
5/8 x 1-1/4



PO104
9/16 x 1-1/2



PO80
1/2 x 1-5/16

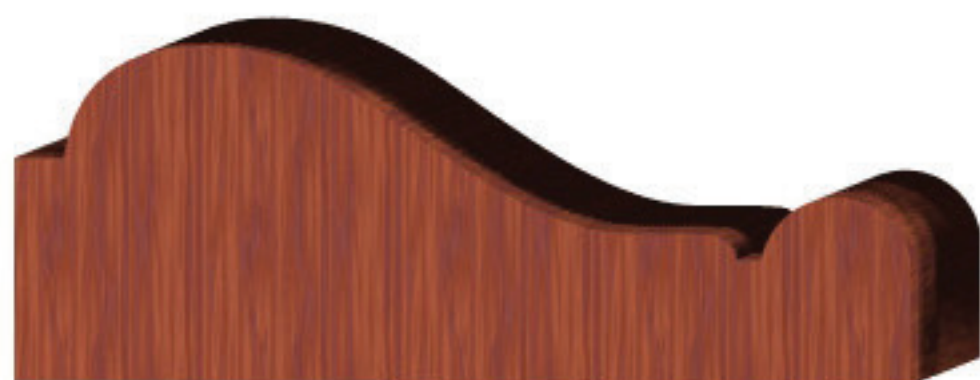

PO76
7/8 x 2-1/4



PO149
3/4 x 1-5/16



PO22
13/16 x 2-1/4



PO113 1 x 2-1/16



PO139 13/16 x 1-1/2



PO128 13/16 x 1-11/16



PO23 3/4 x 2-15/16



PO17 11/16 x 2-1/2



PO78 1-1/8 x 4-1/4



PO85 7/8 x 1-3/4



PO99
13/16 x 1-1/2



PO20
7/8 x 1-3/8



PO127
13/16 x 1-1/8



PO18 3/4 x 1-3/4



PO48 13/16 x 2-1/8



PO77 11/16 x 2



PO93
3/4 x 1-15/16



PO84
1/2 x 15/16



PO103
7/16 x 1-1/16



PO134
5/16 x 3/4



PO30 1 x 3-1/16



PO38 13/16 x 3



PO43 7/8 x 1-7/16

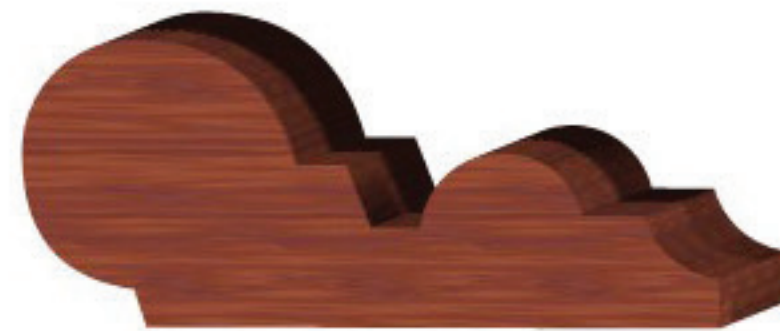

PO65 3/4 x 1-3/4



PO62 9/16 x 1-3/16



PO108 7/8 x 1-7/8



PO102 5/8 x 2



PO141 11/16 x 1-5/8



PO46 1-1/16 x 1-5/8



PO101 15/16 x 1-5/16



PO45 5/8 x 1-3/8

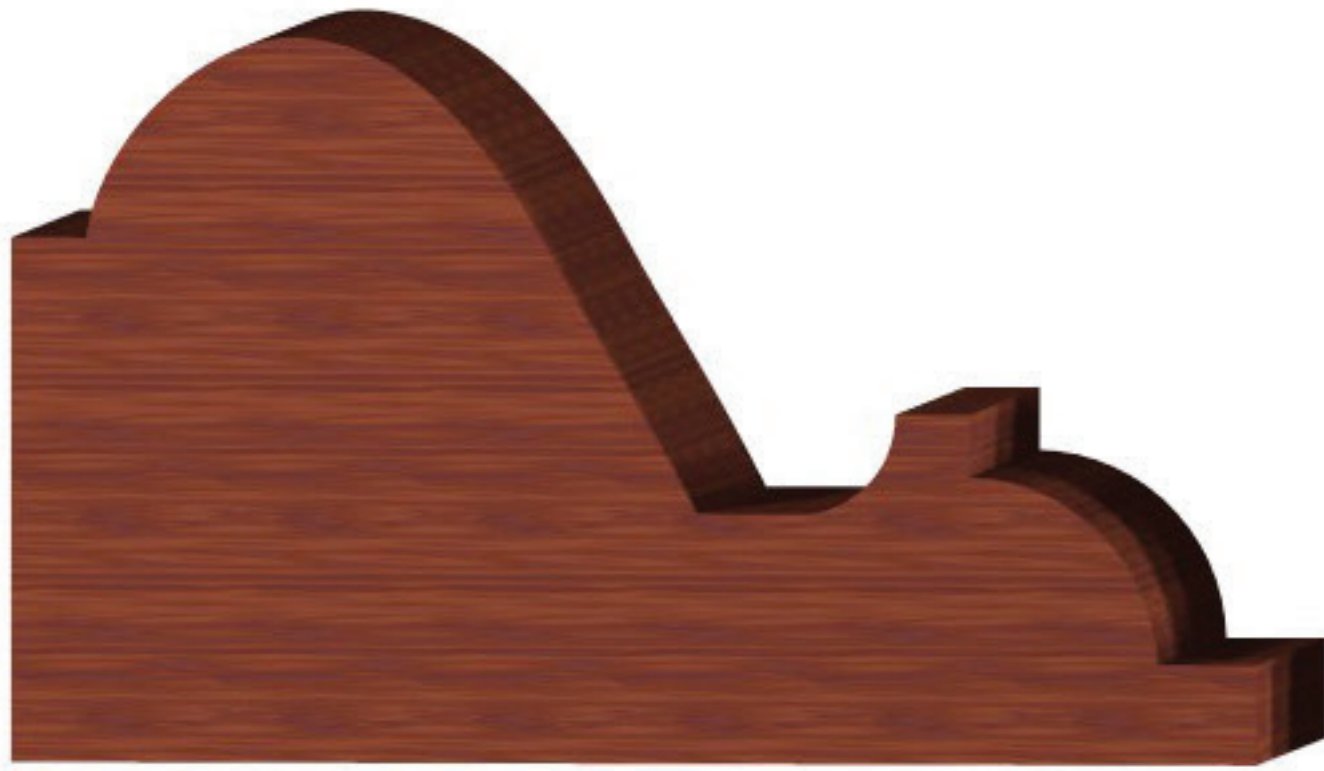

PO59 1-13/16 x 3-1/8

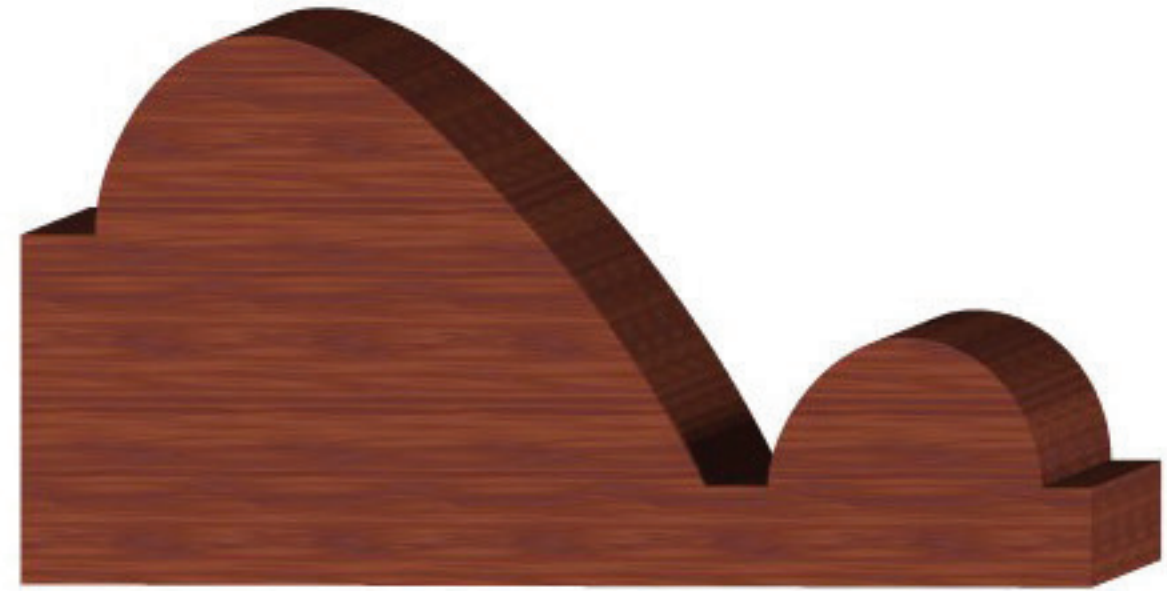

PO57 1-3/8 x 2-11/16



PO52 1-1/16 x 2-9/16



PO42 3/4 x 1-11/16



PO55 11/16 x 1-13/16



PO69 15/16 x 1-1/2



PO68 5/8 x 1-5/8



PO152 9/16 x 1-1/16



PO11 1-11/16 x 5-1/16



PO118
1 x 1-3/16



PO121
7/8 x 1-5/16



PO116
7/8 x 1-1/8



PO160
1 x 1-1/2

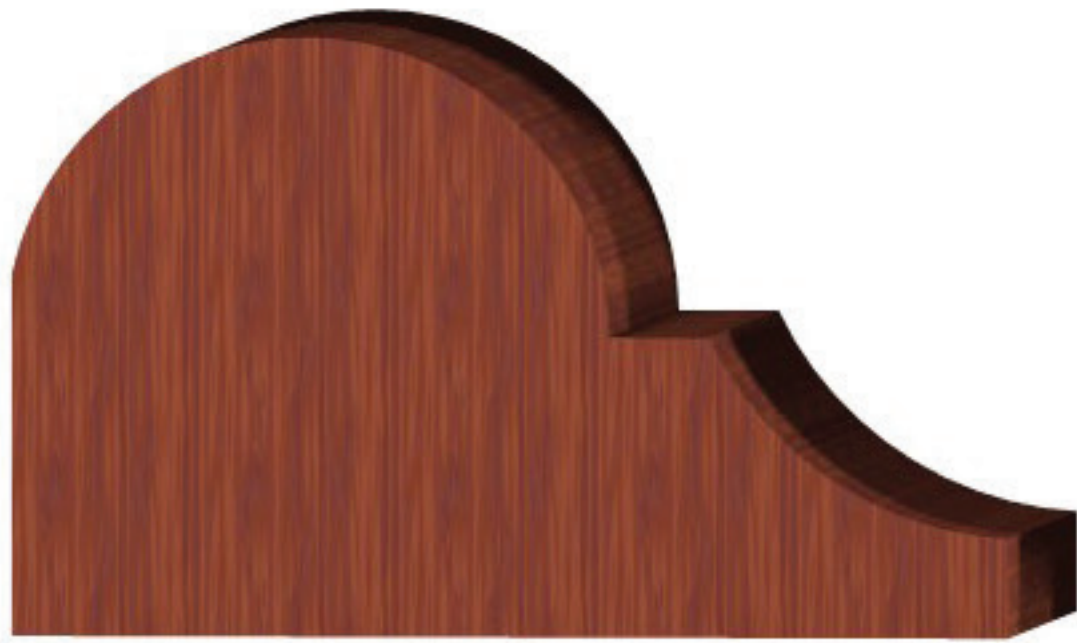

PO119 1-1/2 x 2-1/2



PO91 1-7/16 x 2-3/8



PO129 1-1/4 x 1-1/2



PO110 13/16 x 1-9/16



PO142 1-1/16 x 2-1/16



PO15 1-1/16 x 1-7/16



PO109 1-1/2 x 2-9/16



PO10 1-1/4 x 1-3/4



PO36 1-1/16 x 1-5/8



PO58
3/4 x 2



PO115
9/16 x 1-1/8



PO64
1/2 x 13/16



PO08
3/8 x 11/16

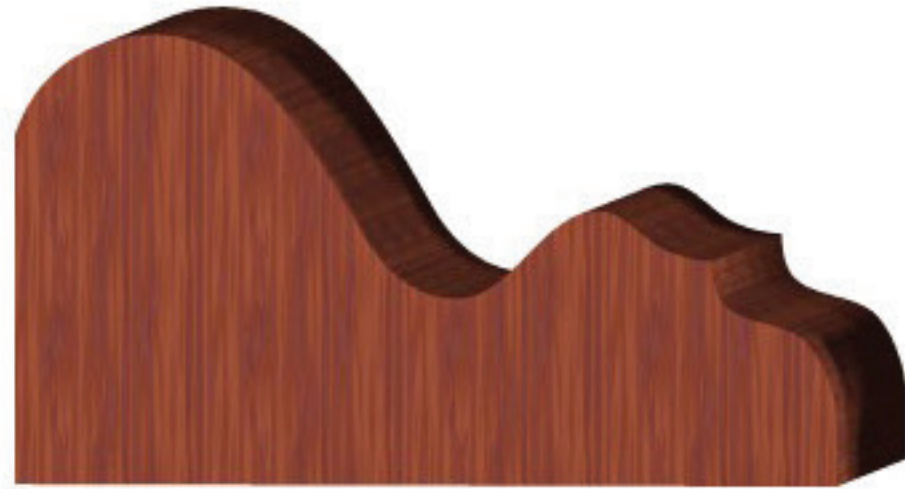

PO117
1-1/8 x 2-1/16



PO133
13/16 x 1-1/2



PO71
13/16 x 1-3/8



PO136
3/4 x 1-5/16



PO28
3/4 x 7/8



PO114
5/8 x 1-11/16



PO63
7/16 x 13/16



PO54
1-1/4 x 2-5/16



PO56
1-1/8 x 1-7/8



PO53
11/16 x 1-13/16



PO140
1-1/16 x 1-1/2



PO60
3/4 x 1-5/8



PO138
13/16 x 1-1/8



PO90
15/16 x 1-5/16

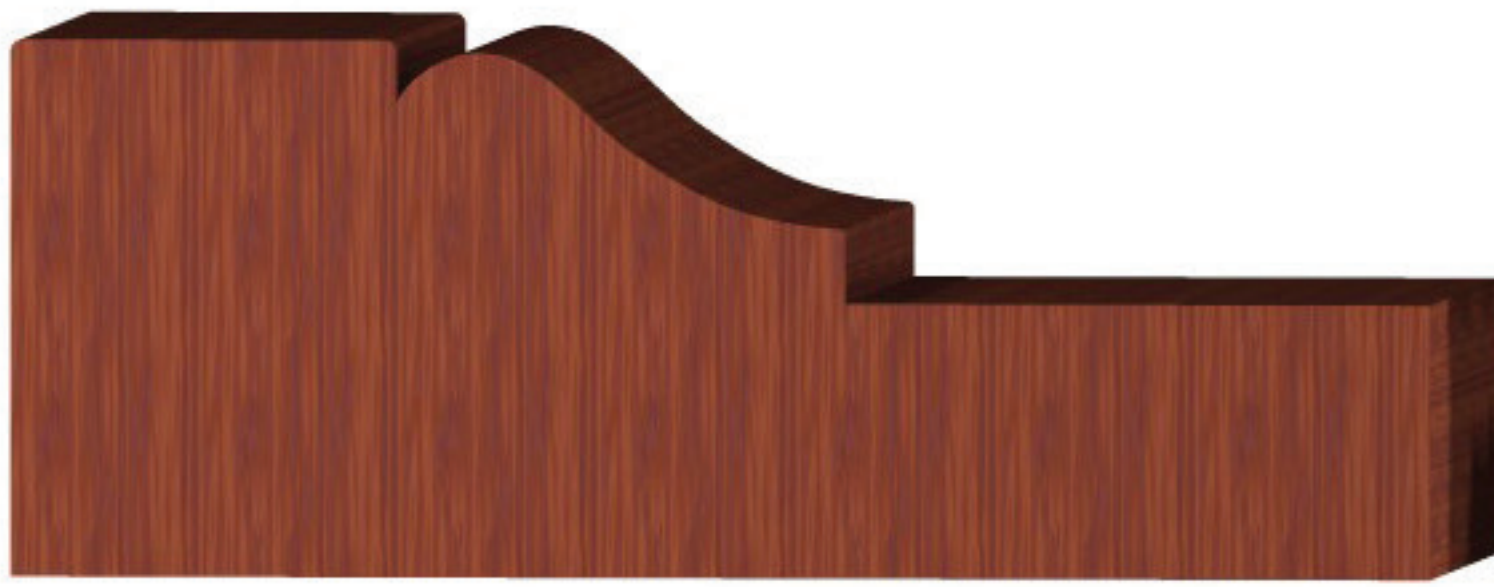

PO87 $1\frac{3}{8}$ x $3\frac{1}{2}$



PO123 1 x $1\frac{13}{16}$



PO33 $1\frac{3}{8}$ x $3\frac{15}{16}$



PO47 $\frac{3}{4}$ x $1\frac{11}{16}$



PO75 $1\frac{3}{4}$ x $3\frac{7}{8}$



PO122 $1\frac{7}{16}$ x $2\frac{7}{16}$

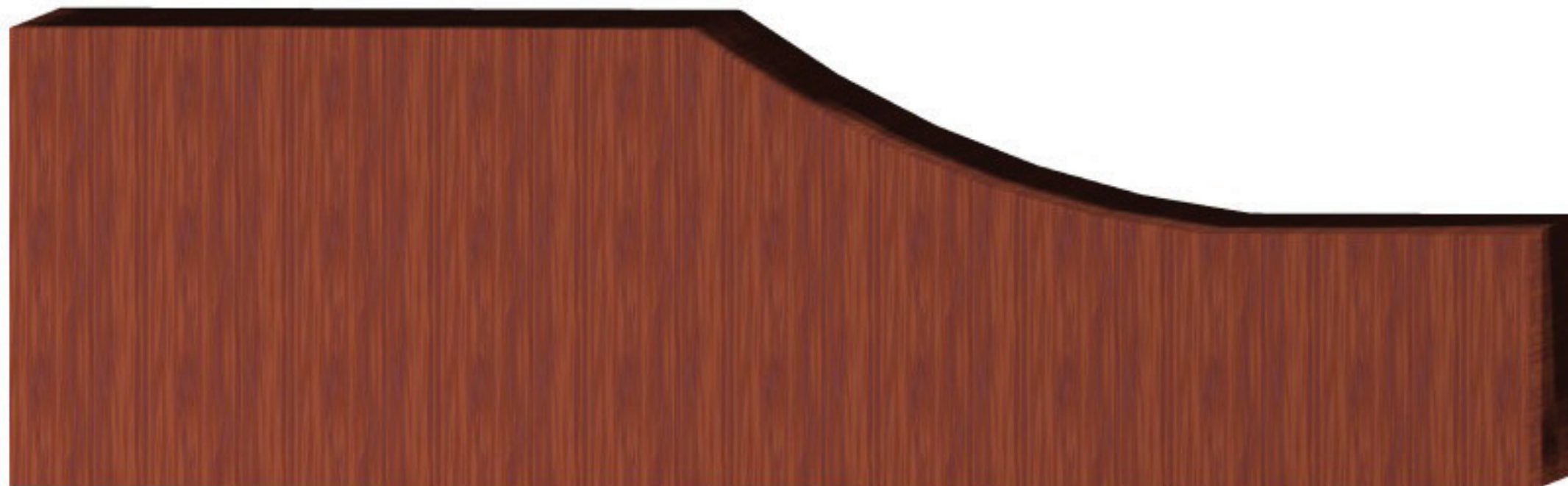

PO86 $1\frac{9}{16}$ x $5\frac{3}{16}$



PO159 $\frac{3}{4}$ x $\frac{7}{8}$



PO41 1-1/4 x 2



PO125 1-1/4 x 1-1/2



PO21 15/16 x 2

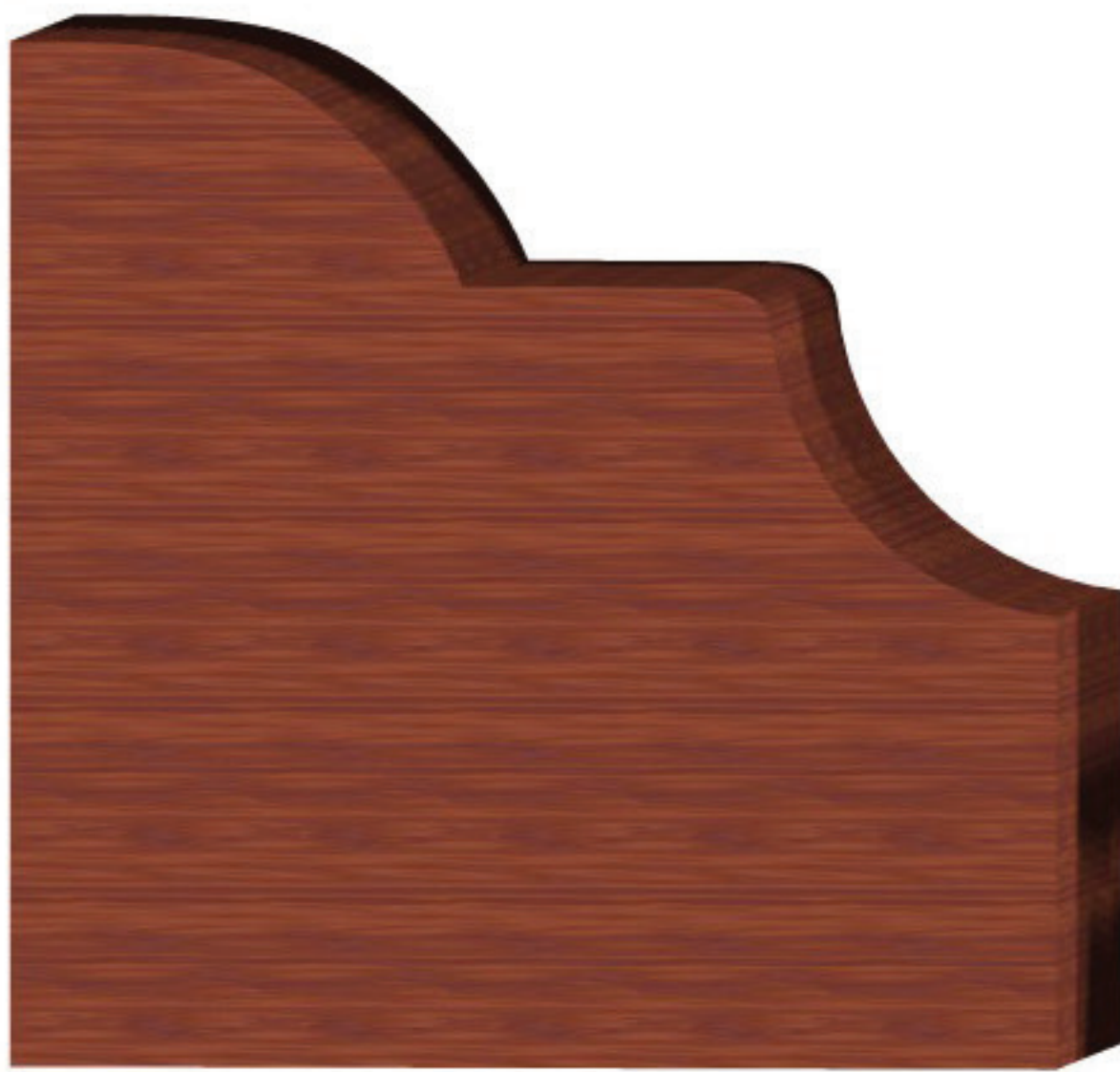

PO124 2-11/16 x 2-3/4



PO50 1-3/8 x 2-1/2

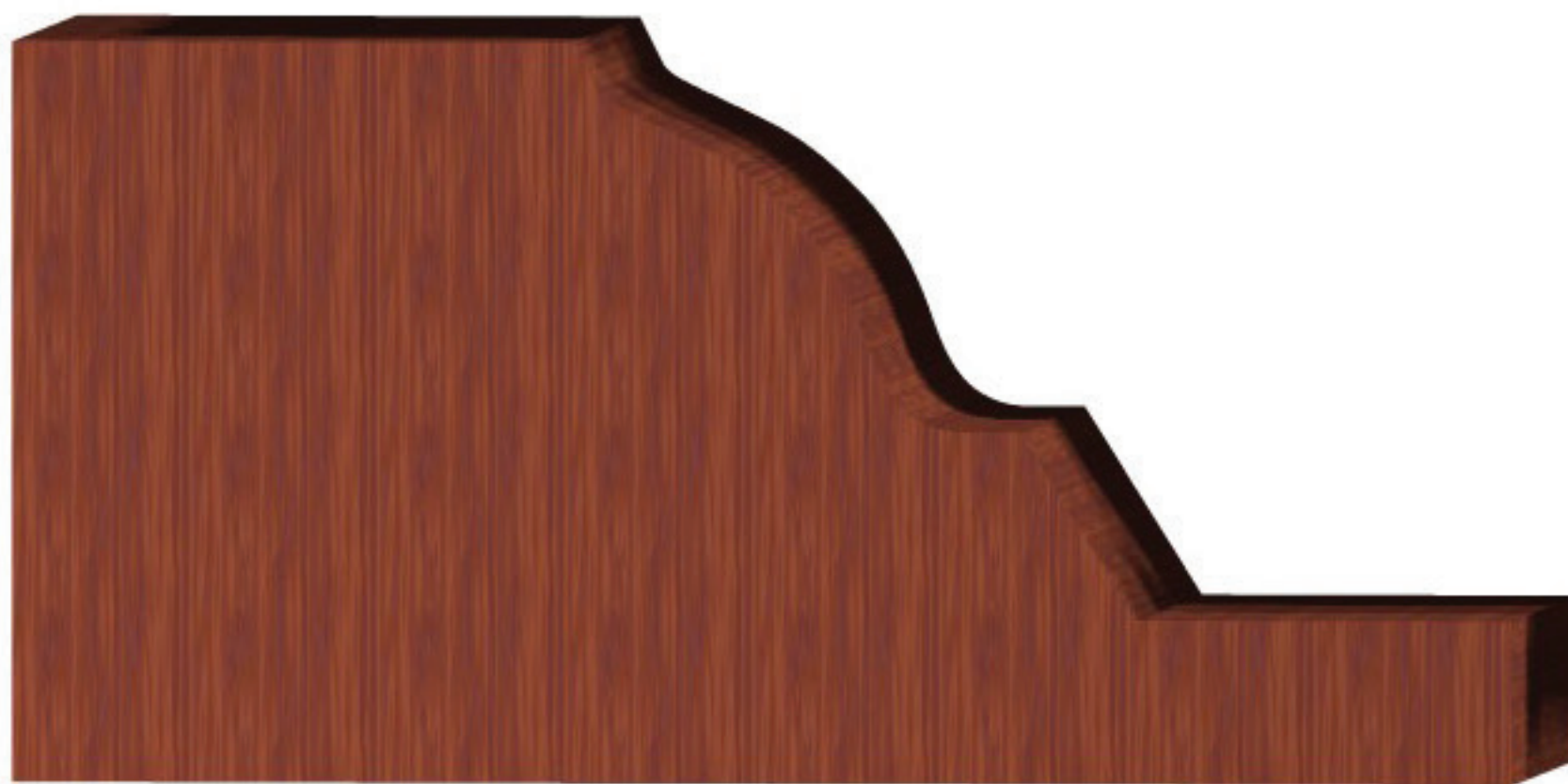

PO111 2 x 4



PO49 7/16 x 1-7/16



PO72 13/16 x 2-1/4



PO82
3/4 x 3-1/2



PO32
9/16 x 1-5/8



PO34
3/4 x 1-7/8



PO24
1/2 x 1-1/2



PO100
3/8 x 3/4



PO126
5/8 x 7/8



PO79
3/4 x 1-3/4



PO16
7/8 x 1-7/8

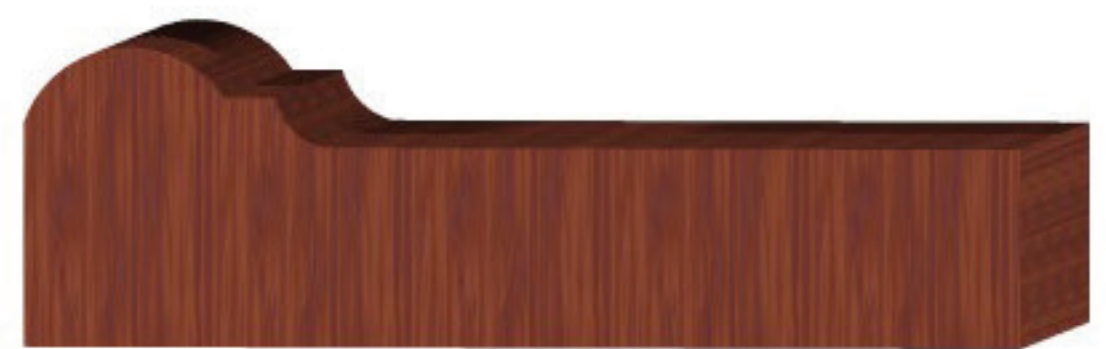

PO81
3/4 x 2-1/2

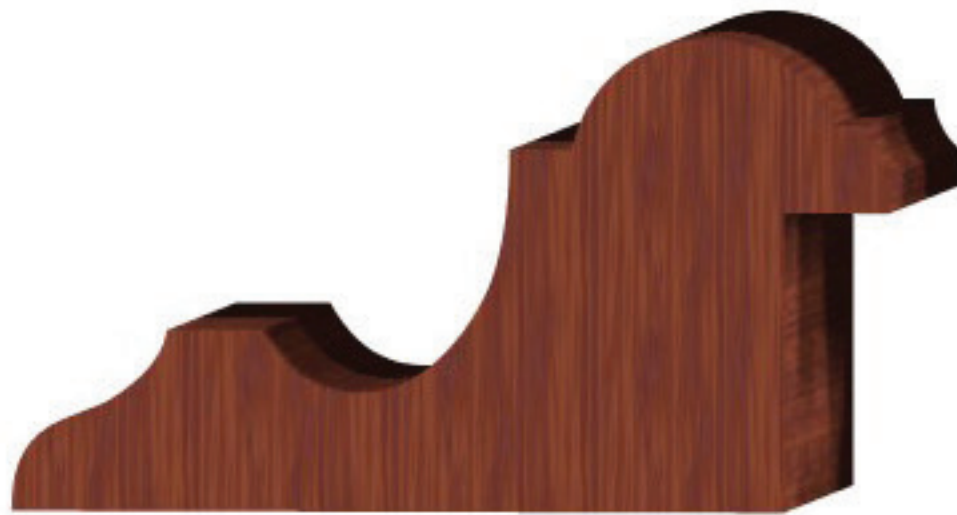

PO132
1-3/16 x 2-7/16



PO105
5/8 x 1-7/16



PO73
9/16 x 1-7/16



PO89
3/4 x 2



PO97
3/4 x 2-7/16



PO92
3/4 x 1-9/16



PO150
1-1/4 x 2



PO145
1-1/8 x 2-1/8



PO29
1 x 1



PO147
5/8 x 1-3/16



PO161
1/2 x 7/8



PO157
5/8 x 13/16



PO130
9/16 x 7/8



PO151
3/4 x 1-1/8



PO155
5/8 x 15/16



PO156
1/2 x 1-1/2



PO146
1-1/8 x 2-5/16



PO148
11/16 x 2-1/4



PO153
15/16 x 1-1/8



PO144
13/16 x 1-5/8



PO143
3/8 x 1-3/16



PO154
7/8 x 1-3/16



PO83
1 x 2-5/16



PO158
5/8 x 1-7/16



PO44
1 x 2-1/16



PO120
3/4 x 1-7/16



PO39
1/2 x 1-1/16



PO70
3/8 x 3/4



PO07
7/16 x 3/4



PO03
3/8 x 3/4



PO96
3/8 x 3/4



PO107
3/4 x 1-3/4



PO04
11/16 x 1-3/4



PO06
1/8 x 1-1/4



PO51
1/2 x 1-1/4



PO66
3/4 x 1-7/8



PO12
11/16 x 1-1/2



PO02
5/6 x 1-1/16



PO14
3/4 x 1-1/2



PO98
9/16 x 15/16



PO13
1/2 x 1-1/2



PO95
7/16 x 1-1/8

RABBET



ID#	Page #	Dimension	ID#	Page #	Dimension
RA01	148	7/8 x 1	RA42	154	11/16 x 2-5/8
RA02	151	1-11/16 x 1-15/16	RA43	154	3/4 x 2-13/16
RA03	152	3/4 x 2-1/4	RA44	152	7/8 x 2
RA04	151	1-1/2 x 1-3/4	RA45	152	7/8 x 2
RA05	150	7/8 x 1-3/8	RA46	154	1-1/8 x 1-3/8
RA06	152	3/4 x 2-7/16	RA47	-	-
RA07	149	1-3/16 x 3-7/16	RA48	150	5/8 x 13/16
RA08	154	1-7/16 x 2-13/16	RA49	149	15/16 x 1-3/4
RA09	148	1-1/16 x 1-1/16	RA50	154	3/4 x 1-3/4
RA10	154	13/16 x 1-5/16	RA51	153	3/4 x 2-5/16
RA11	153	1-1/8 x 1-3/4	RA52	153	1-1/4 x 2-1/4
RA12	149	7/8 x 1	RA53	150	7/8 x 2-1/4
RA13	152	13/16 x 1-3/4	RA54	153	1/2 x 2
RA14	150	5/8 x 1-3/16	RA55	150	1 x 1-1/4
RA15	150	3/4 x 1-3/8	RA56	153	3/4 x 2-5/16
RA16	148	3/4 x 2-1/8	RA57	153	1-1/8 x 2-5/16
RA17	152	7/8 x 1-15/16	RA58	149	1-3/16 x 1-7/16
RA18	151	5/8 x 1	RA59	148	1 x 2
RA19	148	1-1/8 x 1-1/8	RA60	150	1-1/8 x 2-1/16
RA20	151	3/4 x 1-5/16	RA61	148	1-3/16 x 2-5/8
RA21	149	5/8 x 15/16	RA62	151	1-3/4 x 2-7/8
RA22	151	1-1/8 x 1-5/16	RA63	154	1-1/2 x 3-3/8
RA23	153	3/4 x 2	RA64	153	1-1/8 x 1-5/16
RA24	150	3/4 x 1-3/8	RA65	-	-
RA25	148	1 x 2-1/8	RA66	150	7/8 x 1-3/8
RA26	153	9/16 x 1-1/8	RA67	148	1-3/16 x 2-5/16
RA27	148	13/16 x 1-1/2	RA68	151	7/8 x 1-3/4
RA28	148	3/4 x 1-1/2	RA69	151	13/16 x 1-1/4
RA29	152	13/16 x 2-7/16	RA70	150	9/16 x 1-1/8
RA30	148	1-9/16 x 1-3/4	RA71	152	11/16 x 2-7/8
RA31	149	3/4 x 1-1/4	RA72	149	5/8 x 1-1/16
RA32	153	3/4 x 1-7/16	RA73	150	7/8 x 1-1/8
RA33	151	11/16 x 1-1/16	RA74	149	1-1/16 x 1-1/16
RA34	154	1-7/8 x 2-9/16	RA75	149	15/16 x 1-15/16
RA35	153	3/4 x 1-1/4	RA76	151	1-1/4 x 1-1/2
RA36	153	7/8 x 2	RA77	154	1-1/2 x 3-3/8
RA37	-	-	RA78	154	1/2 x 1-3/4
RA38	150	7/8 x 1-13/16	RA79	153	1-1/8 x 2
RA39	152	1 x 1-5/8	RA80	149	13/16 x 1-3/4
RA40	152	7/8 x 2-1/2	RA81	150	15/16 x 3-3/16
RA41	152	13/16 x 1-13/16	RA82	150	3/4 x 1/8

ID#	Page #	Dimension	ID#	Page #	Dimension
RA83	150	7/8 x 1-13/16			
RA84	150	11/16 x 1-1/8			
RA85	152	11/16 x 1-3/4			
RA86	150	5/8 x 1-3/16			
RA87	149	13/16 x 2			
RA88	150	1-1/16 x 1-1/2			
RA89	149	1-1/16 x 1-11/16			
RA90	151	1 x 1			
RA91	149	1-1/8 x 1-5/8			
RA92	150	13/16 x 1-1/8			
RA93	152	5/8 x 2-3/16			
RA94	-	-			
RA95	150	3/4 x 1			
RA96	149	3/4 x 1-1/16			
RA97	150	1-1/8 x 1-3/4			
RA98	152	1-3/8 x 2-3/4			
RA99	149	3/4 x 1-1/4			
RA100	153	11/16 x 1-9/16			
RA101	154	1-7/8 x 4			
RA102	151	13/16 x 1-1/16			
RA103	-	-			
RA104	149	5/8 x 1-3/16			
RA105	153	7/8 x 1-5/8			
RA106	149	1-3/16 x 2-1/2			
RA107	151	1-3/8 x 2-1/4			
RA108	154	1/2 x 3/4			
RA109	148	1-5/16 x 2-1/16			
RA110	148	1-3/8 x 1-11/16			
RA111	152	1 x 1-3/4			
RA112	149	15/16 x 1-15/16			
RA113	148	1-3/16 x 1-7/8			
RA114	151	1-1/8 x 1-7/16			
RA115	150	1-3/8 x 1-1/2			
RA116	153	5/8 x 2-1/16			
RA117	153	3/4 x 1-1/4			
RA118	149	5/8 x 7/8			
RA119	148	7/16 x 1-5/8			
RA120	148	1-1/4 x 1-3/4			
RA121	150	11/16 x 1-11/16			

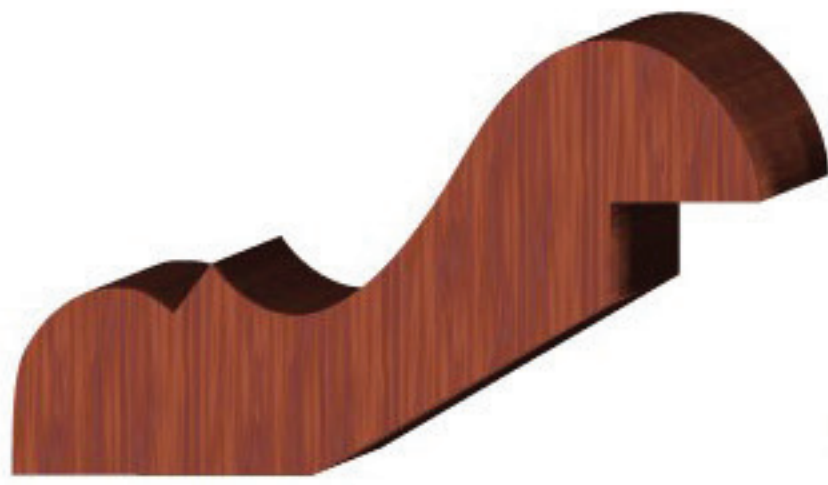

RA25
1 x 2-1/8



RA109
1-5/16 x 2-1/16



RA59
1 x 2



RA28
3/4 x 1-1/2



RA113
1-3/16 x 1-7/8



RA110
1-3/8 x 1-11/16



RA16
3/4 x 2-1/8

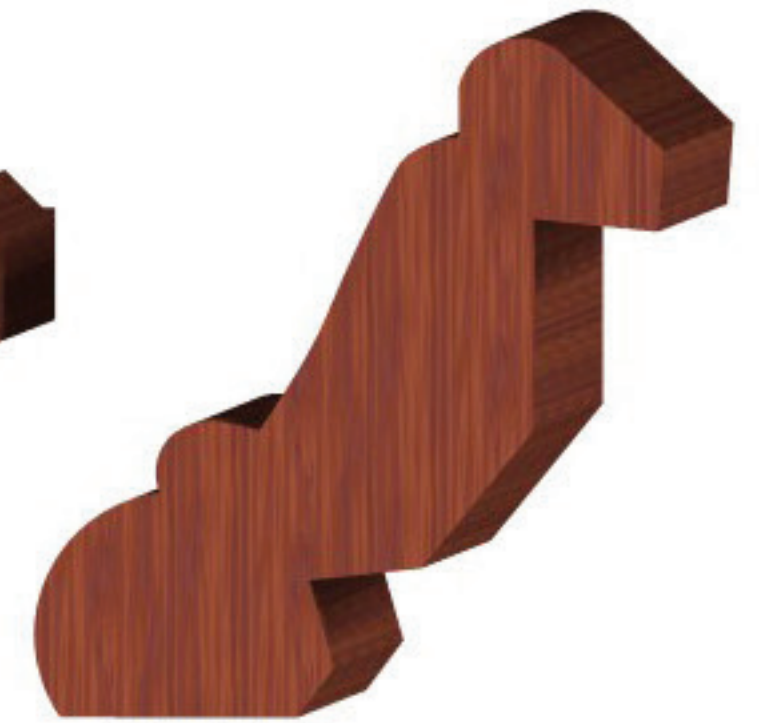

RA30
1-9/16 x 1-3/4



RA61
1-3/16 x 2-5/8



RA67
1-3/16 x 2-5/16



RA119
7/16 x 1-5/8



RA27
13/16 x 1-1/2



RA19
1-1/8 x 1-1/8



RA09
1-1/16 x 1-1/16



RA01
7/8 x 1



RA120
1-1/4 x 1-3/4



RA91
1-1/8 x 1-5/8



RA49
15/16 x 1-3/4



RA12
7/8 x 1



RA21
5/8 x 15/16



RA118
5/8 x 7/8

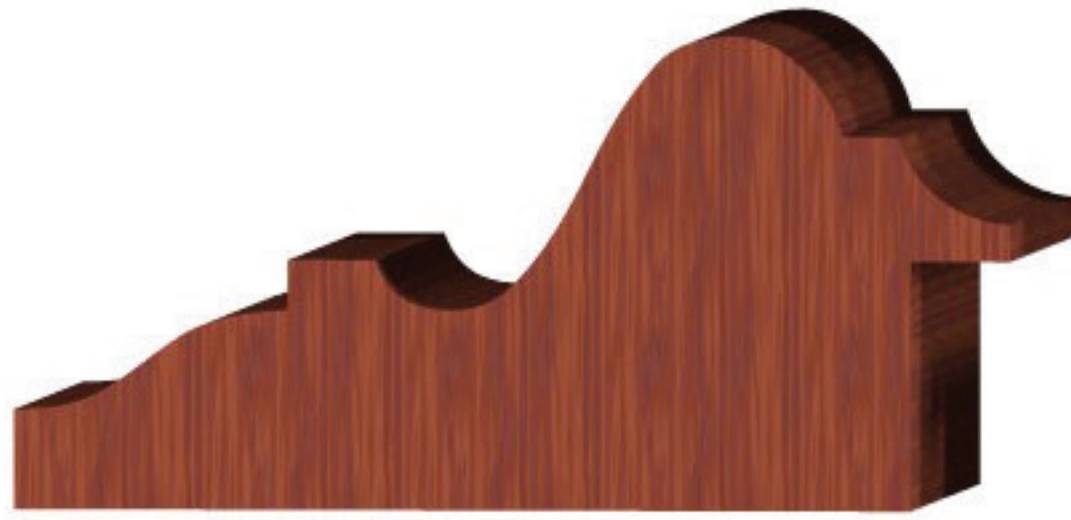

RA106
1-3/16 x 2-1/2



RA112
15/16 x 1-15/16

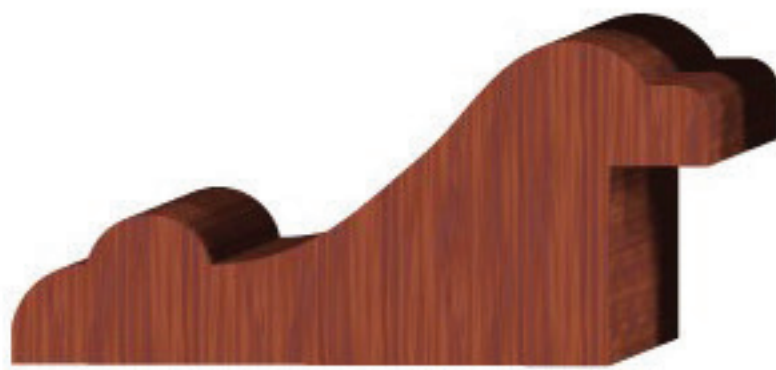

RA80
13/16 x 1-3/4

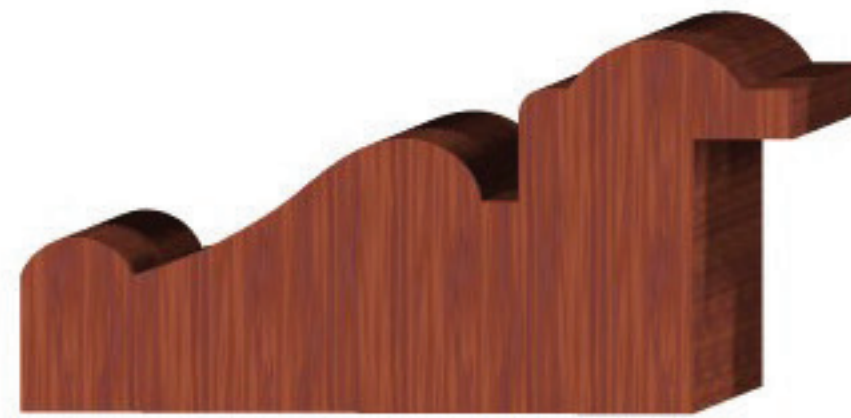

RA75
15/16 x 1-15/16

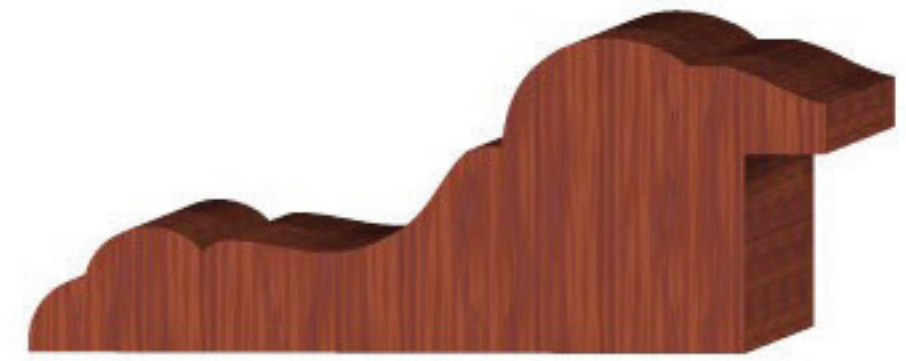

RA87
13/16 x 2



RA89
1-1/16 x 1-11/16



RA96
3/4 x 1-1/16



RA99
3/4 x 1-1/4



RA104
5/8 x 1-3/16



RA72
5/8 x 1-1/16

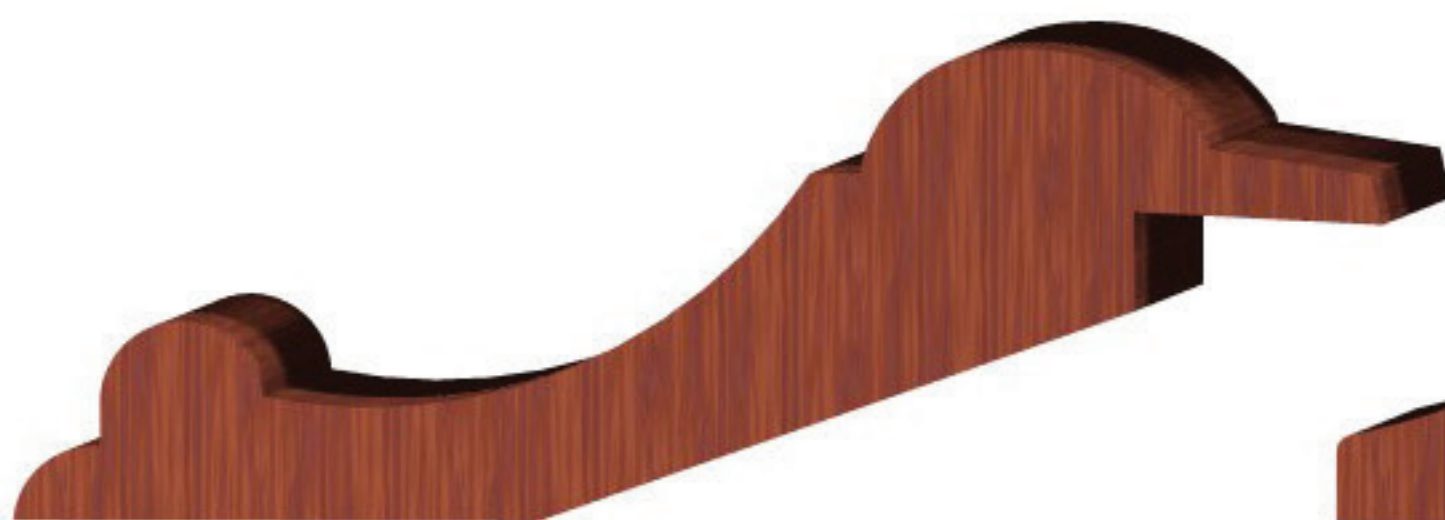

RA07
1-3/16 x 3-7/16



RA58
1-3/16 x 1-7/16



RA74
1-1/16 x 1-1/16



RA31
3/4 x 1-1/4



RA115
1-3/8 x 1-1/2



RA97
1-1/8 x 1-3/4



RA88
1-1/16 x 1-1/2



RA55
1 x 1-1/4



RA53
7/8 x 2-1/4



RA66
7/8 x 1-3/8



RA84
11/16 x 1-1/8



RA82
3/4 x 1/8

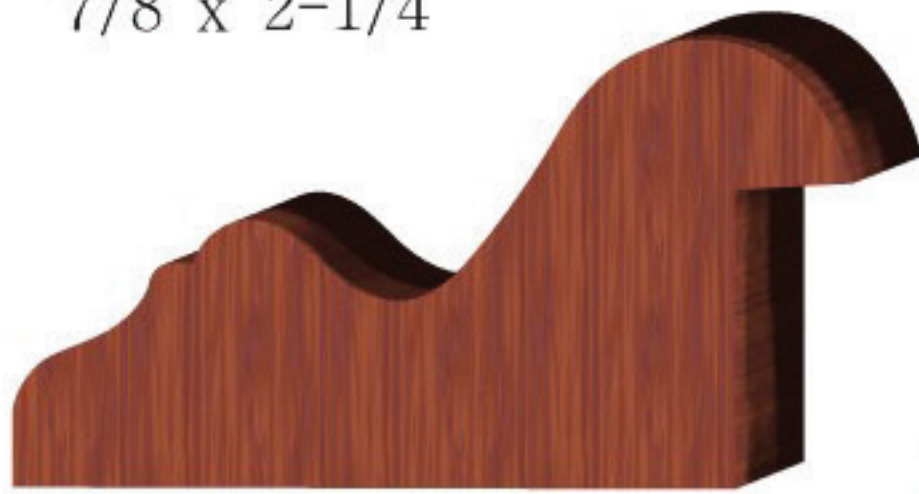

RA60
1-1/8 x 2-1/16



RA83
7/8 x 1-13/16

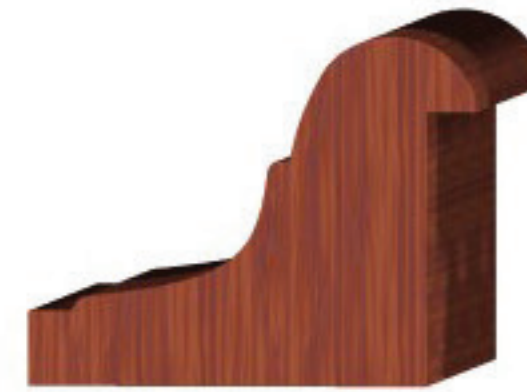

RA73
7/8 x 1-1/8



RA86
5/8 x 1-3/16



RA24
3/4 x 1-3/8



RA38
7/8 x 1-13/16



RA05
7/8 x 1-3/8



RA15
3/4 x 1-3/8



RA95
3/4 x 1



RA48
5/8 x 13/16



RA14
5/8 x 1-3/16



RA70
9/16 x 1-1/8



RA92
13/16 x 1-1/8



RA121
11/16 x 1-11/16



RA81
15/16 x 3-3/16



RA62
1-3/4 x 2-7/8



RA68
7/8 x 1-3/4



RA22
1-1/8 x 1-5/16



RA20
3/4 x 1-5/16



RA18
5/8 x 1



RA114
1-1/8 x 1-7/16



RA76
1-1/4 x 1-1/2



RA69
13/16 x 1-1/4



RA90
1 x 1



RA33
11/16 x 1-1/16



RA107
1-3/8 x 2-1/4



RA02
1-11/16 x 1-15/16



RA04
1-1/2 x 1-3/4



RA102
13/16 x 1-1/16



RA29 $13/16$ x $2-7/16$



RA17 $7/8$ x $1-15/16$

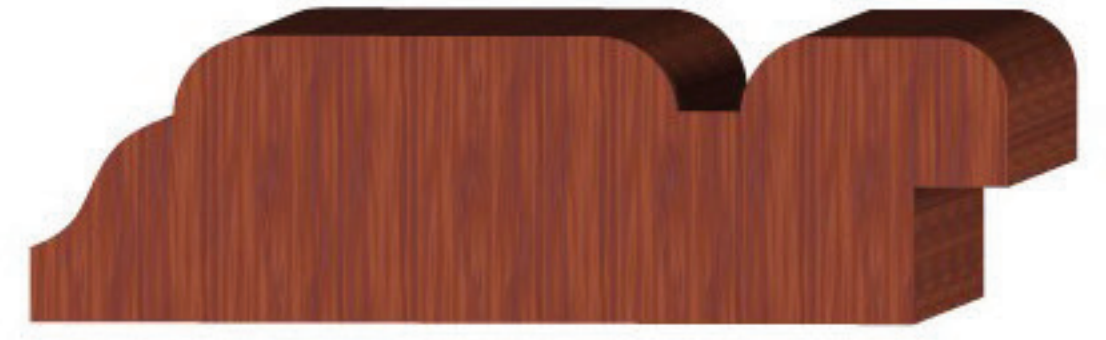

RA06 $3/4$ x $2-7/16$



RA13 $13/16$ x $1-3/4$



RA03 $3/4$ x $2-1/4$



RA39 1 x $1-5/8$



RA40 $7/8$ x $2-1/2$



RA93 $5/8$ x $2-3/16$



RA44 $7/8$ x 2



RA45 $7/8$ x 2

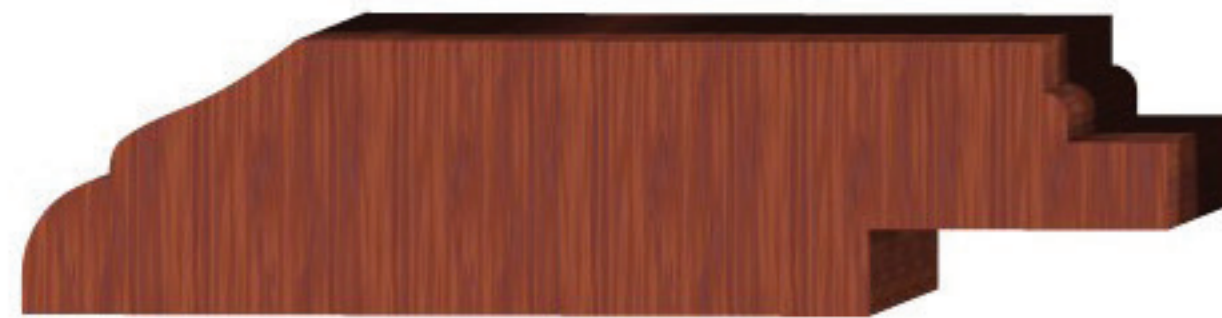

RA71 $11/16$ x $2-7/8$



RA41 $13/16$ x $1-13/16$

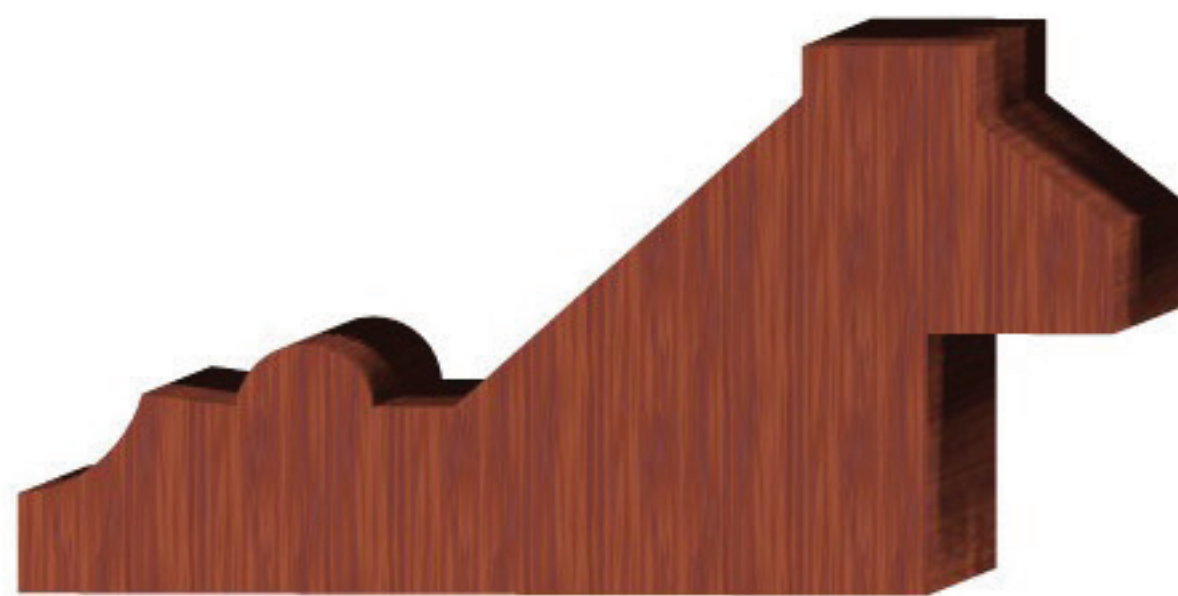

RA98 $1-3/8$ x $2-3/4$



RA85 $11/16$ x $1-3/4$



RA111 1 x $1-3/4$



RA64 1-1/8 x 1-5/16



RA51 3/4 x 2-5/16



RA57 1-1/8 x 2-5/16



RA11 1-1/8 x 1-3/4



RA36 7/8 x 2

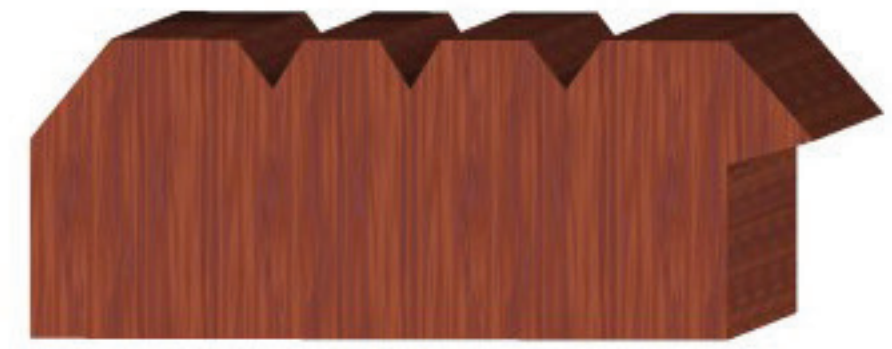

RA23 3/4 x 2



RA54 1/2 x 2



RA32 3/4 x 1-7/16



RA35 3/4 x 1-1/4



RA52 1-1/4 x 2-1/4



RA79 1-1/8 x 2



RA100 11/16 x 1-9/16



RA56 3/4 x 2



RA26 9/16 x 1-1/8

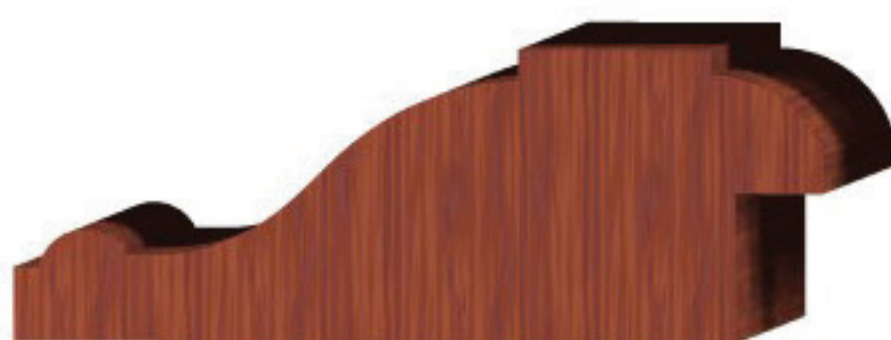

RA116 5/8 x 2-1/16

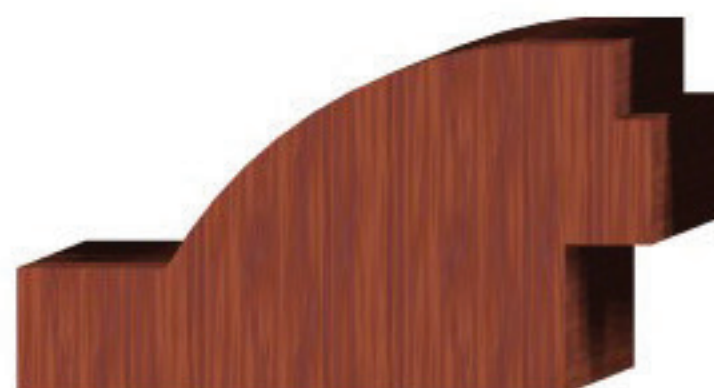

RA105 7/8 x 1-5/8



RA117 3/4 x 1-1/4

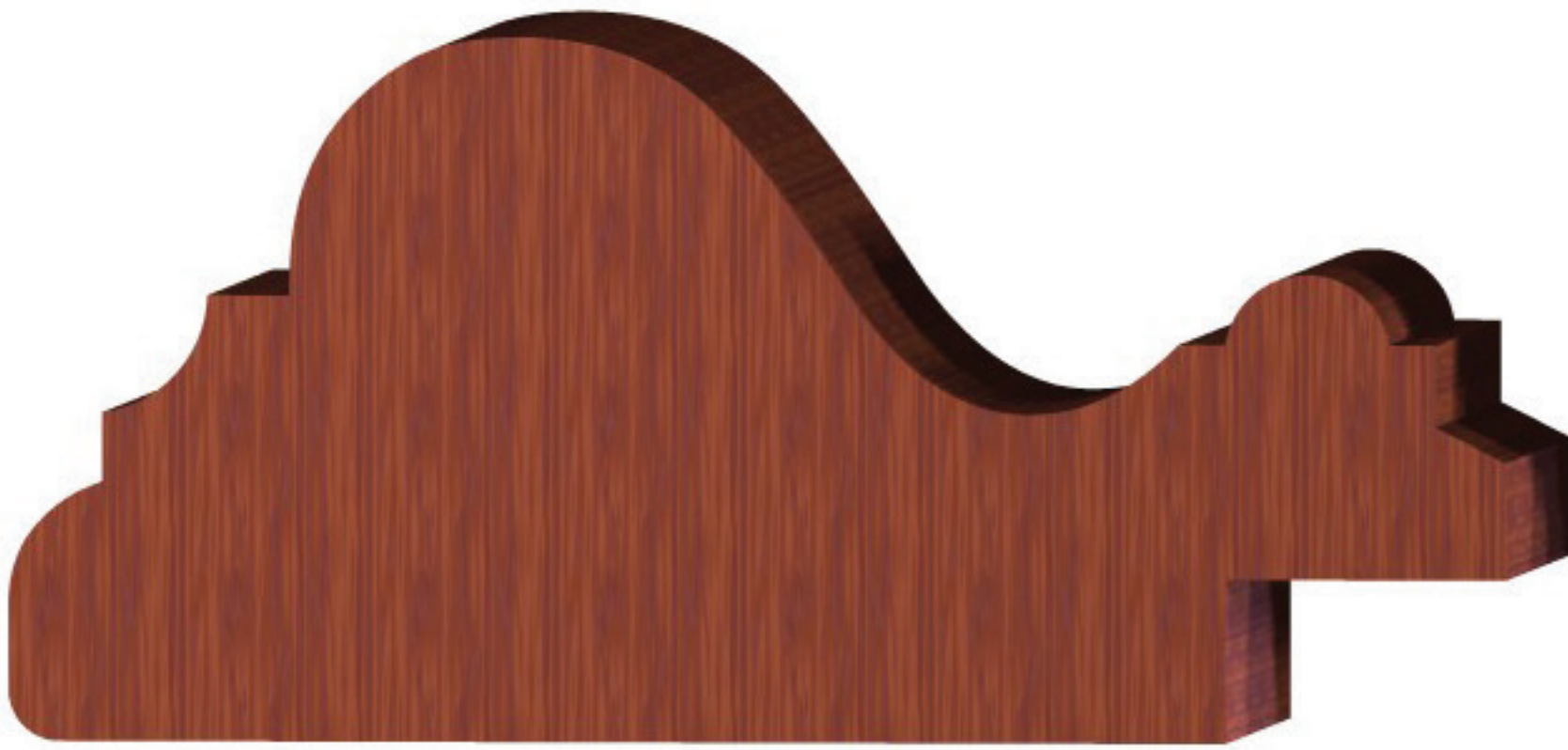

RA101 1-7/8 x 4



RA10
13/16 x 1-5/16



RA108
1/2 x 3/4

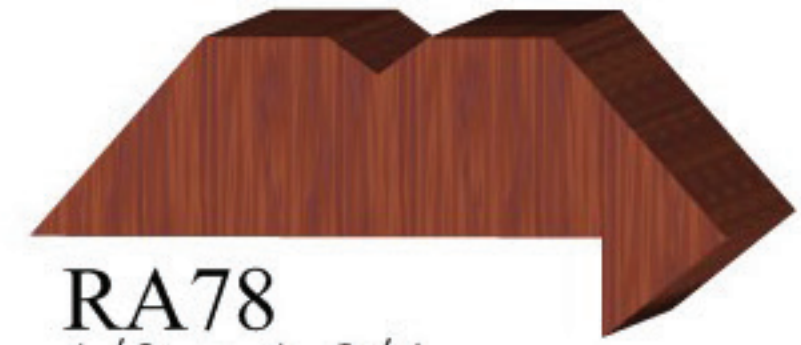

RA78
1/2 x 1-3/4



RA63 1-1/2 x 3-3/8



RA77 1-5/16 x 2-1/2



RA43 3/4 x 2-13/16



RA34 1-7/8 x 2-9/16



RA42 11/16 x 2-5/8



RA50 3/4 x 1-3/4



RA46 1-1/8 x 1-3/8



RA08 1-7/16 x 2-13/16

STOP



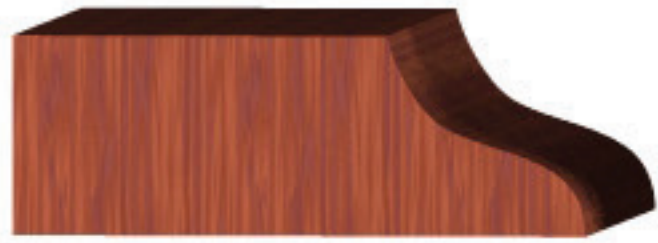

SS30 1/2 x 1-7/16



SS12 1/2 x 1-3/8



SS04 1/2 x 1-5/16



SS11 5/16 x 1-5/16

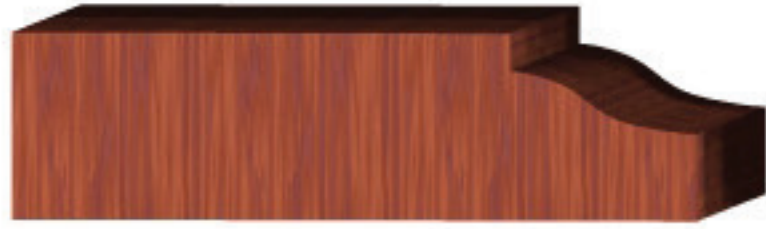

SS10 1/2 x 1-3/4



SS02 3/8 x 1-7/8



SS03 3/8 x 1-3/8



SS33
1/2 x 3/4



SS27
9/16 x 7/8



SS26
9/16 x 13/16



SS25
9/16 x 5/8



SS28
1/2 x 9/16



SS29
7/16 x 5/8

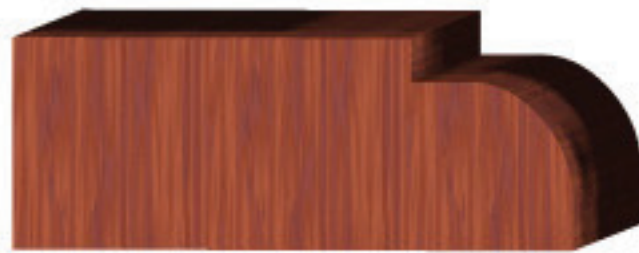

SS24 9/16 x 1-7/16

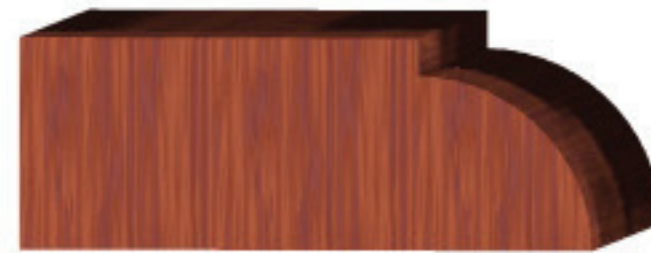

SS23 9/16 x 1-7/16



SS13 1/2 x 1-1/2



SS06
1/2 x 1



SS20
9/16 x 13/16



SS19
5/8 x 3/4



SS21
9/16 x 11/16



SS22
7/16 x 9/16



SS18
3/8 x 5/8



SS14
13/16 x 1-3/4



SS31
9/16 x 1



SS01
5/16 x 1-1/16



SS32
7/16 x 7/16

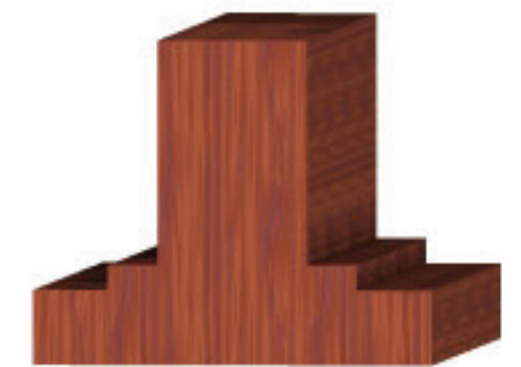

SS17
13/16 x 1



SS16
1/2 x 1-13/16

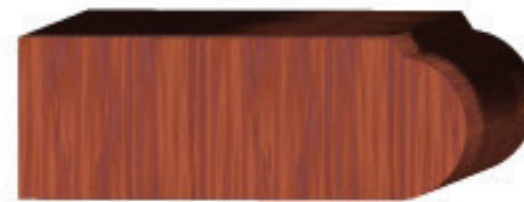

SS15
7/16 x 1-1/8



SS09
3/8 x 1-11/16



SS08 1/2 x 1-1/2



SS07 7/16 x 1-1/4



SS05 3/8 x 1-11/16

STAIR





ST06 1-5/16 x 5-1/2



ST05 1-3/4 x 4-1/16



ST04 1-11/16 x 5-9/16



ST6042 1-1/4 x 2-1/4



ST11 1-1/2 x 1-3/8



ST16 1-5/16 x 2-1/4



ST6040 1-3/4 x 1-5/8



ST6039 1-3/4 x 1-3/4



ST6010 2-5/16 x 2-3/8



ST8000 2-1/4 x 2-5/8

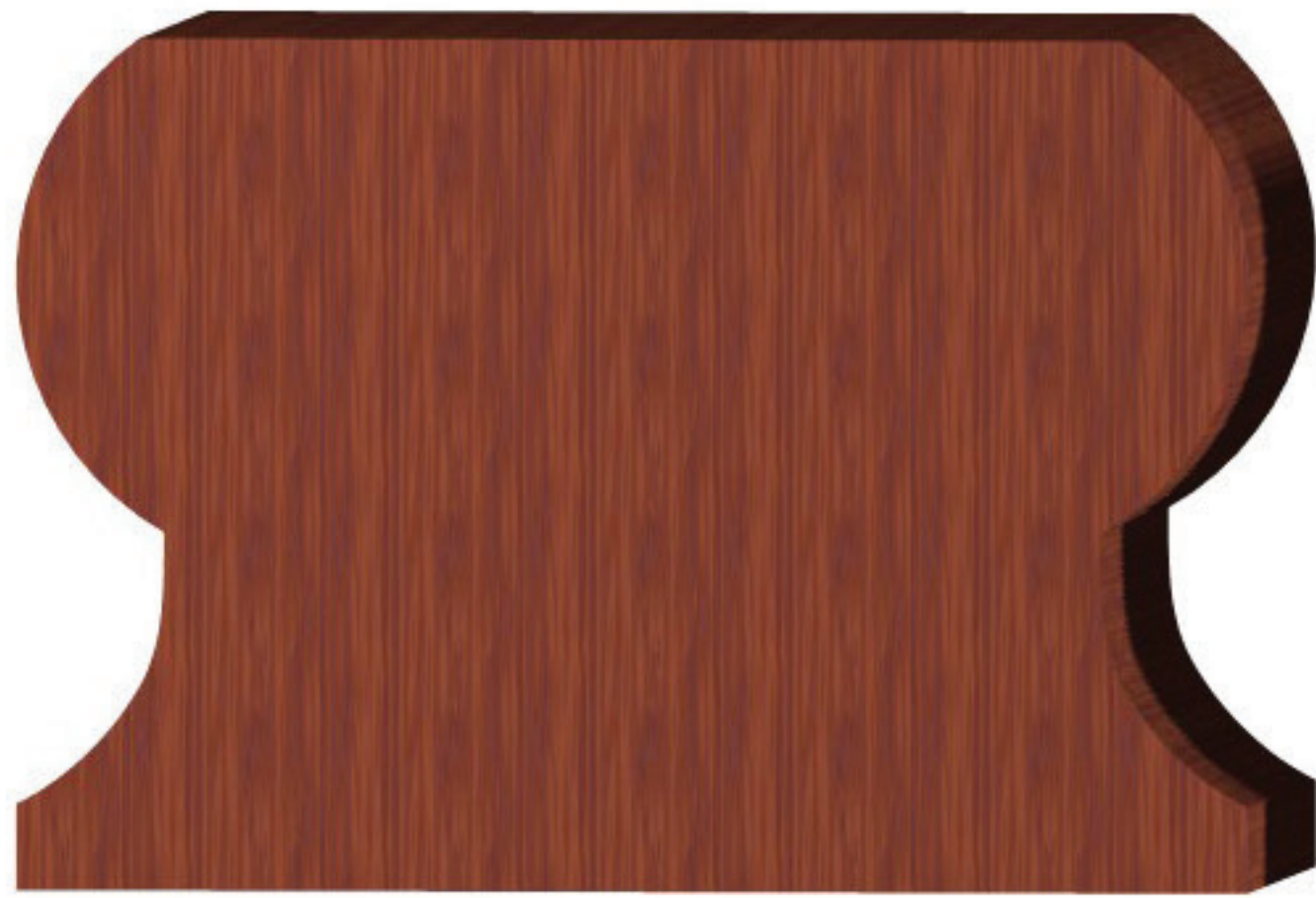

ST8001 2-3/16 x 3-1/8

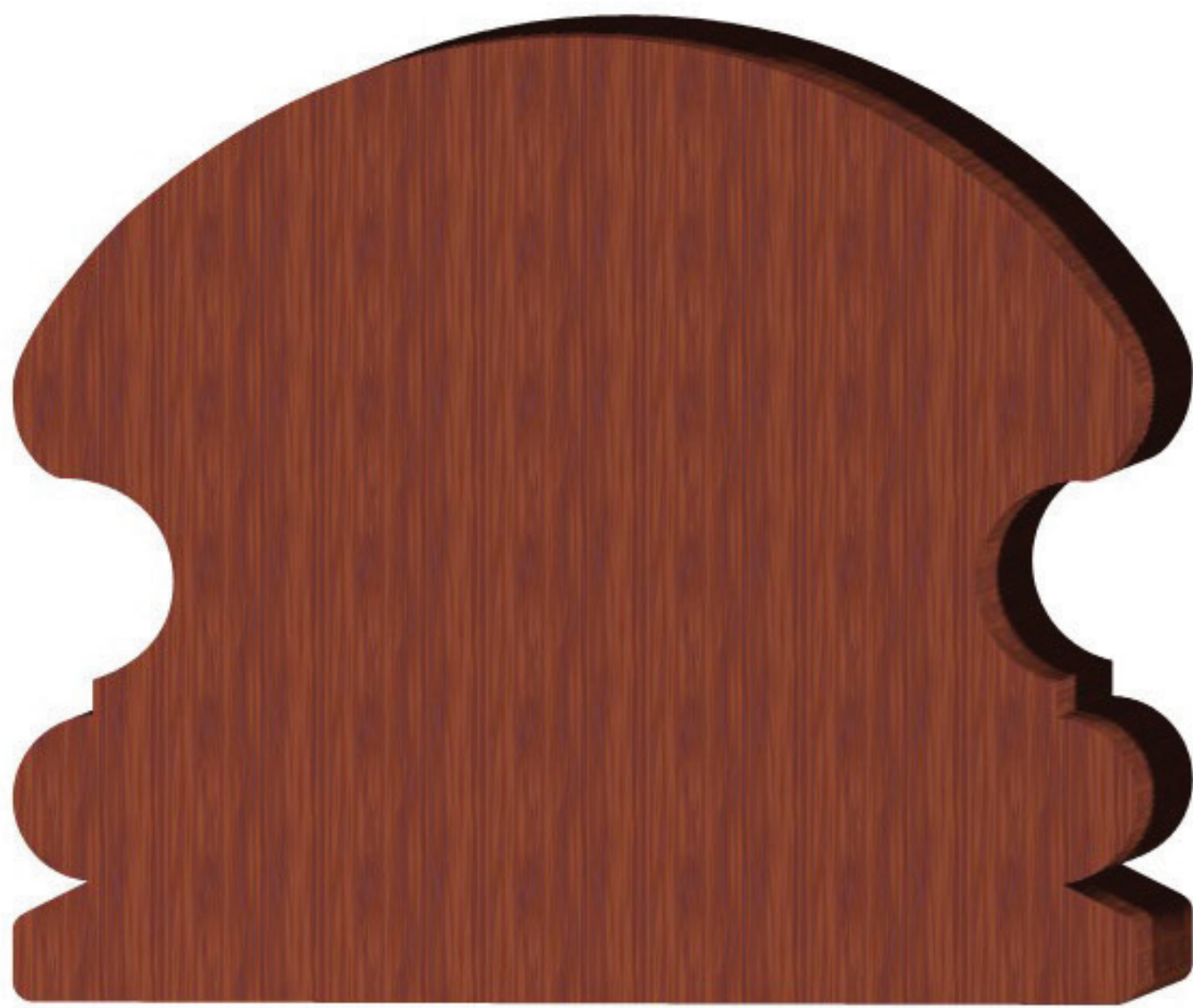

ST6043 3 x 3-1/2



ST8002 1-11/16 x 5-11/16



ST02 2-1/2 x 3-11/16



ST03 1-1/2 x 1-1/2

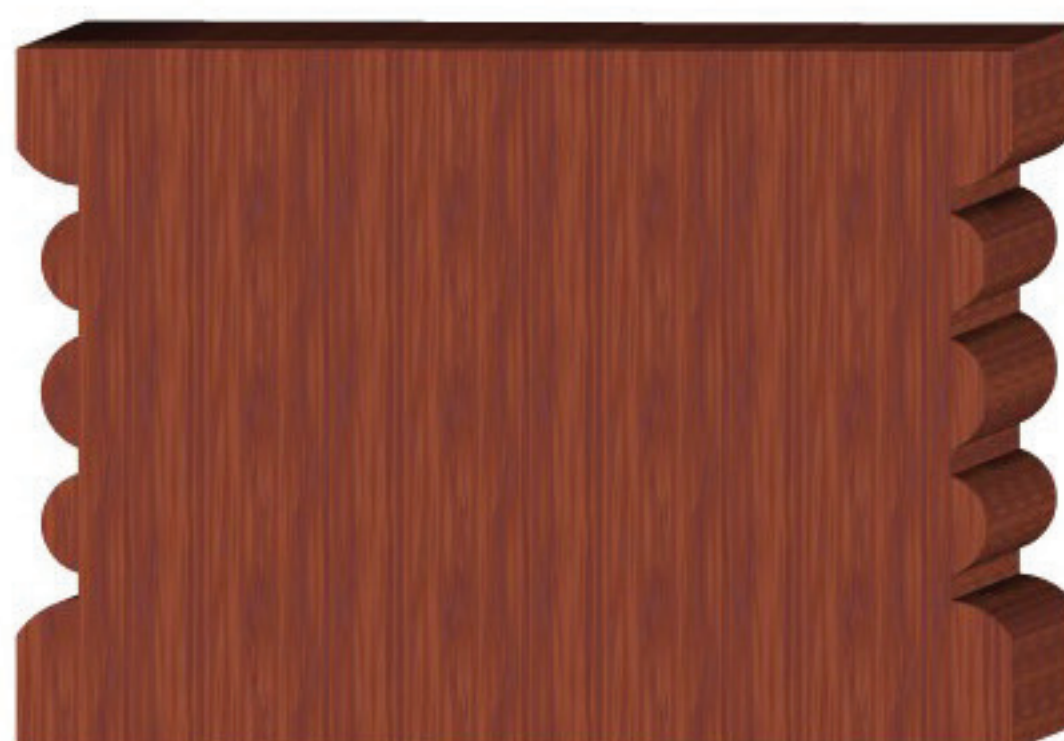

ST01 1-3/4 x 2-1/2



ST14 1-1/8 x 3-1/4

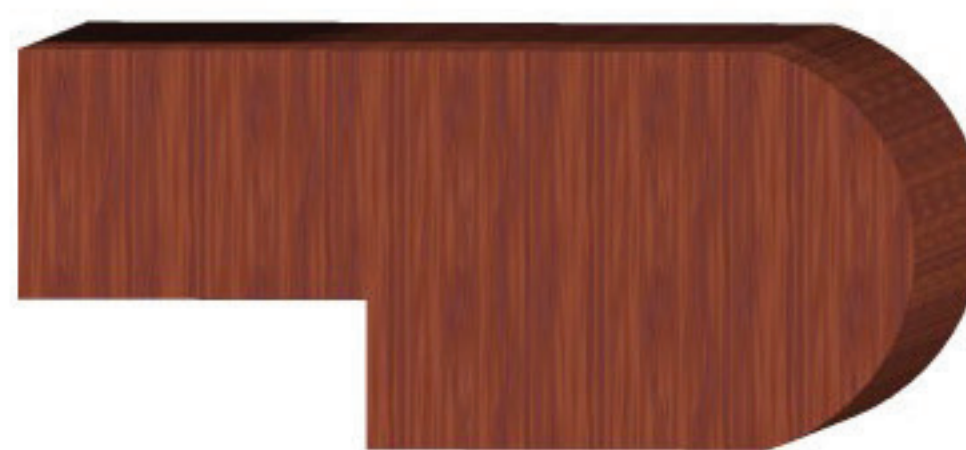

ST15 1 x 2-1/4



ST8006 1-1/2 x 5-7/16



ST6044 2-1/2 x 4

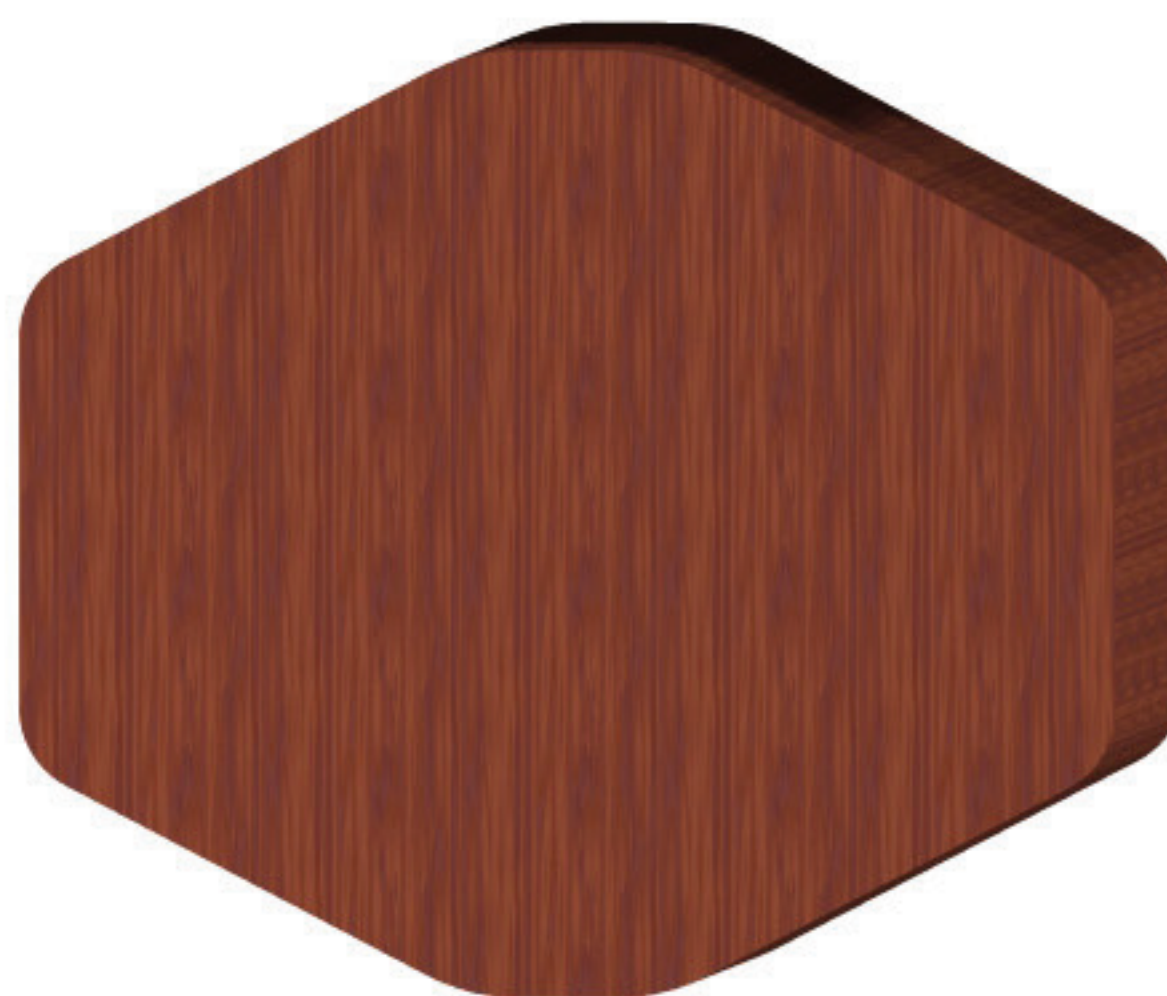

ST18 2-3/8 x 2-3/4



ST6050

ST6045 $\frac{3}{4}$ x $2\frac{1}{2}$



ST6052

ST6046 1 x $3\frac{1}{16}$



ST17 $\frac{1}{4}$ x $1\frac{1}{4}$



ST6041 $1\frac{1}{4}$ x $2\frac{9}{16}$



ST8007
 $3\frac{5}{16}$ x $5\frac{1}{8}$

BAR RAIL

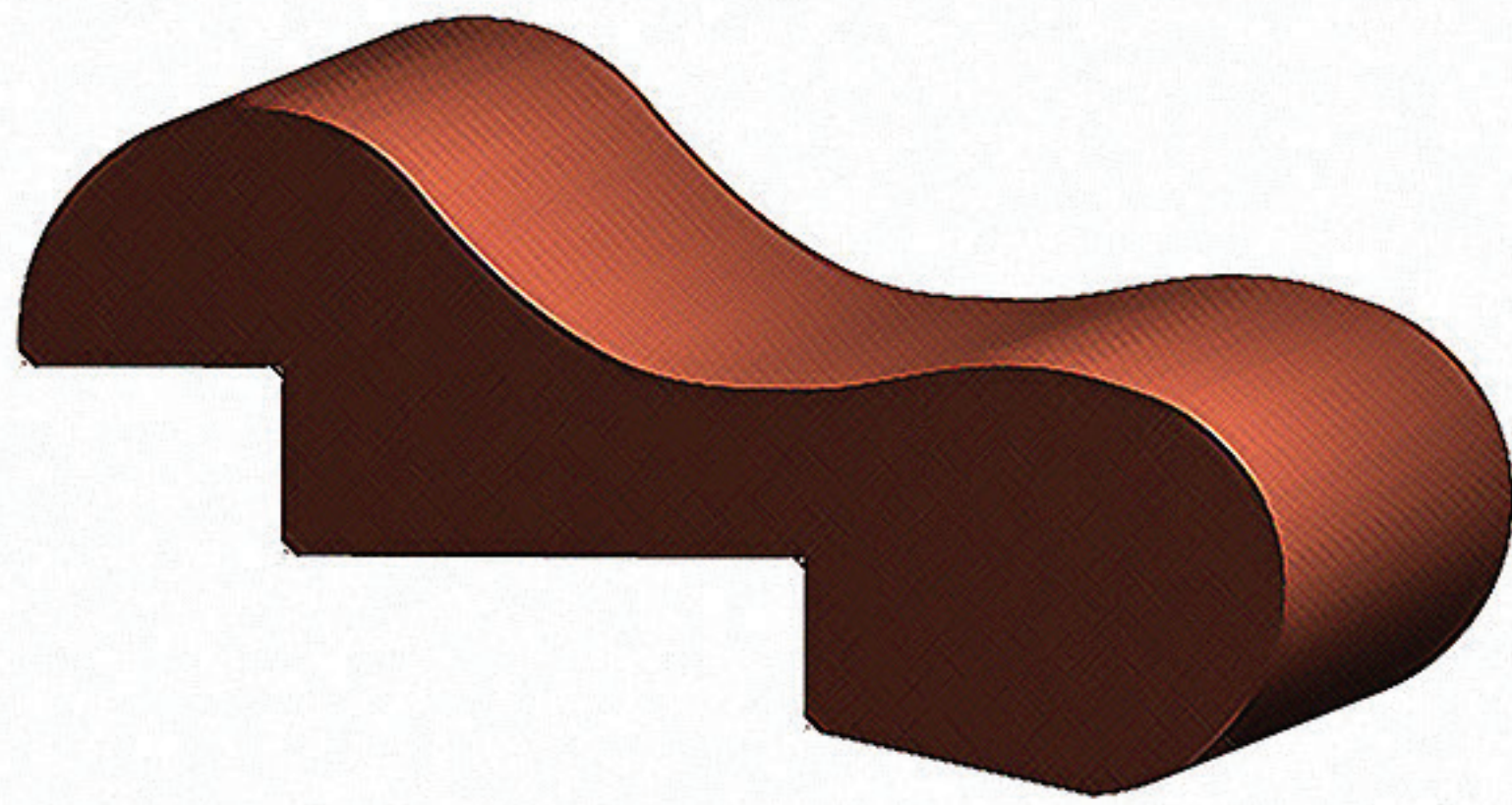



BR01
1-3/4 x 5-1/2



BR02
1-3/4 x 5

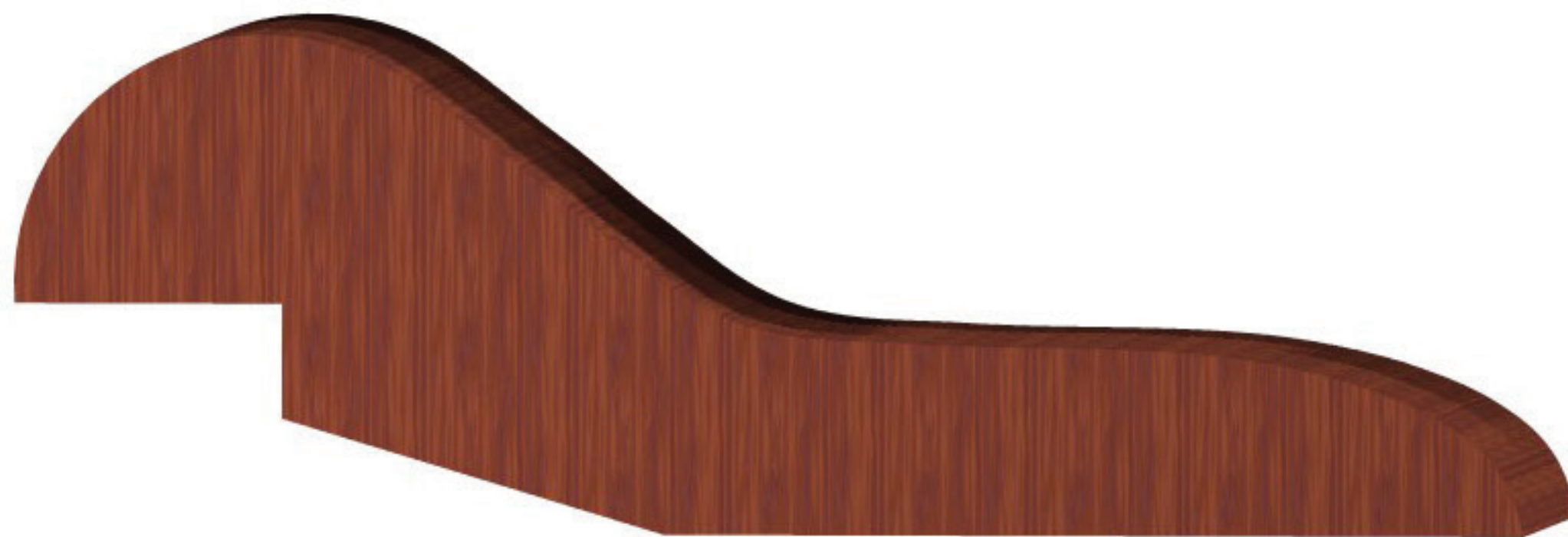

BR03
1-1/8 x 5-1/4

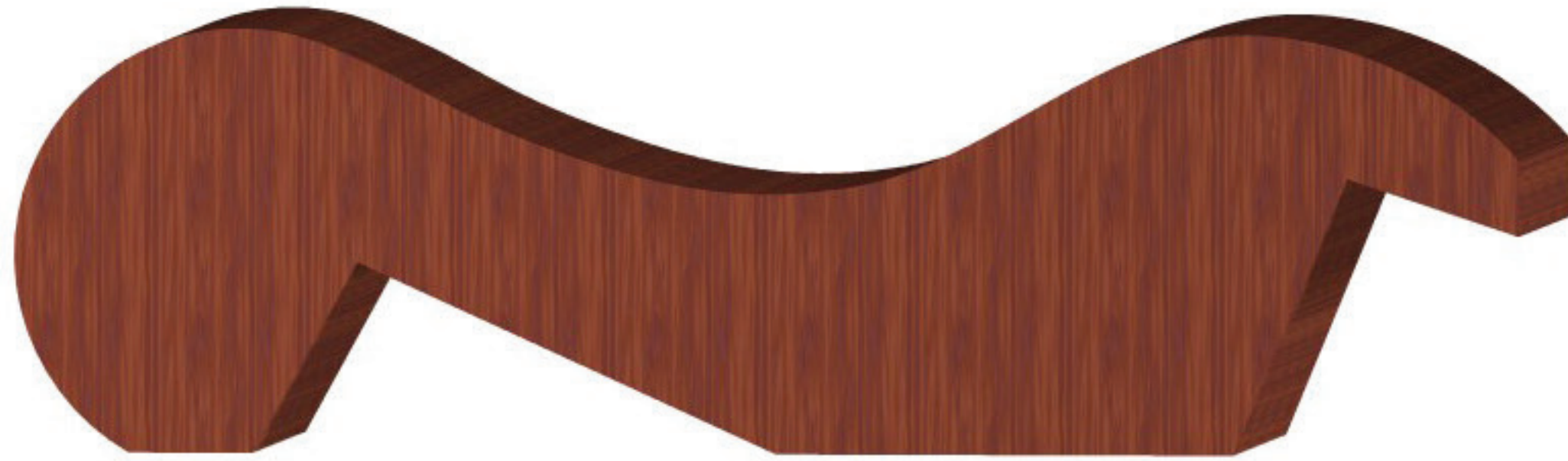

BR04
1-3/8 x 5

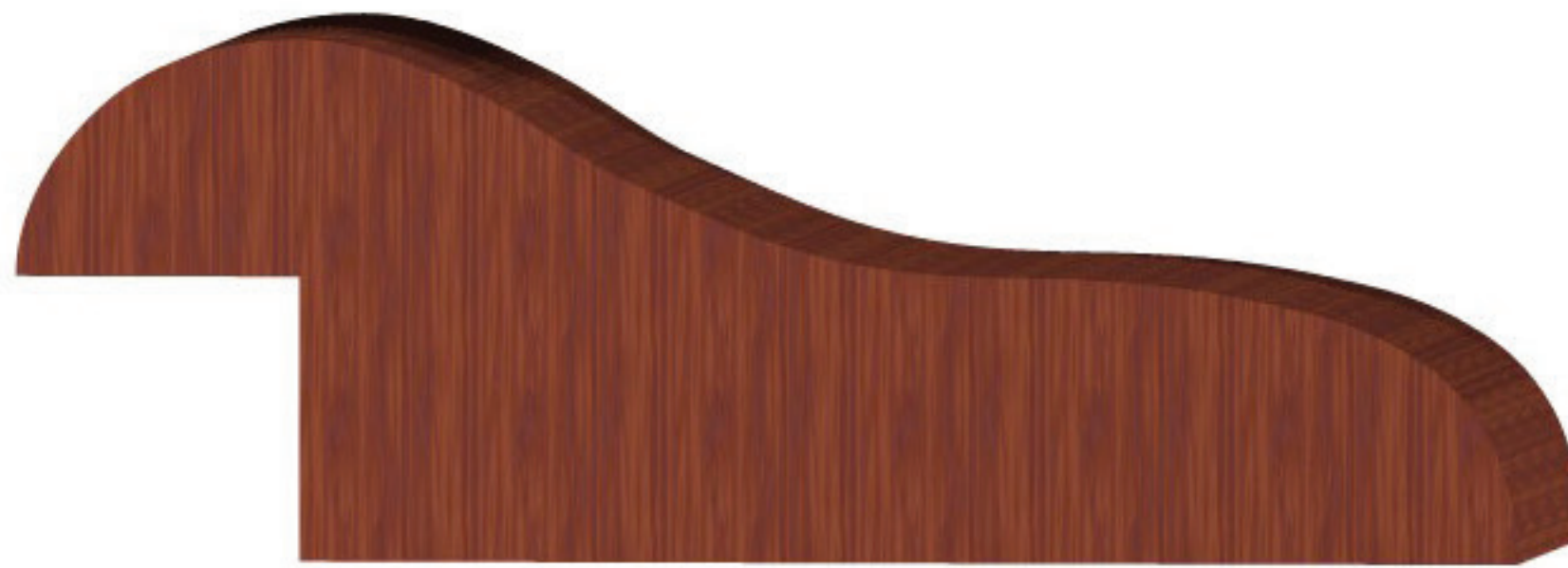

BR06
1-3/8 x 4

WAINSCOT



ID#	Page #	Dimension	ID#	Page #	Dimension
WS01	171	3/4 x 4-7/8	WS42	173	3/4 x 5-15/16
WS02	172	3/4 x 7-1/8	WS43	169	5/8 x 6
WS03	168	3/8 x 3-1/2	WS44	174	11/16 x 9-1/8
WS04	169	1-3/16 x 2-5/16	WS45	168	5/16 x 3-5/16
WS05	169	11/16 x 3-1/4	WS46	168	3/8 x 3-1/8
WS06	171	7/8 x 5-1/2	WS47	171	3/4 x 4-7/8
WS07	171	11/16 x 5-1/16	WS48	172	13/16 x 7-1/2
WS08	171	5/8 x 4-3/8			
WS09	172	3/4 x 7	WS76	170	5/8 x 3-7/8
WS10	172	13/16 x 7-3/8			
WS11	173	3/4 x 7			
WS12	169	1/2 x 3-1/8			
WS13	168	11/16 x 3-5/16			
WS14	169	13/16 x 2-3/16			
WS15	169	3/4 x 3-9/16			
WS16	173	1-3/8 x 5-1/4			
WS17	168	3/8 x 3-1/2			
WS18	168	3/4 x 3-3/8			
WS19	168	3/8 x 2-5/8			
WS20	169	13/16 x 2-7/8			
WS21	168	3/8 x 3-1/2			
WS22	168	11/16 x 3-7/16			
WS23	-	-			
WS24	168	3/8 x 3-1/2			
WS25	170	3/4 x 2-1/8			
WS26	-	-			
WS27	168	3/8 x 2-7/8			
WS28	172	9/16 x 6			
WS29	-	-			
WS30	173	1-1/16 x 5-3/8			
WS31	169	3/4 x 2-11/16			
WS32	169	13/16 x 2-1/4			
WS33	170	1/2 x 2-3/4			
WS34	168	5/8 x 3-3/16			
WS35	171	13/16 x 5-3/8			
WS36	170	13/16 x 3-9/16			
WS37	170	7/8 x 5-1/4			
WS38	173	1-1/2 x 7-1/2			
WS39	170	1/2 x 2-5/8			
WS40	172	3/4 x 6-1/4			
WS41	170	3/4 x 5-1/2			



WS17 $\frac{3}{8}$ x $3\frac{1}{2}$



WS19 $\frac{3}{8}$ x $2\frac{5}{8}$



WS27 $\frac{3}{8}$ x $2\frac{7}{8}$



WS24 $\frac{3}{8}$ x $3\frac{1}{2}$



WS21 $\frac{3}{8}$ x $3\frac{1}{2}$



WS03 $\frac{3}{8}$ x $3\frac{1}{2}$



WS46 $\frac{3}{8}$ x $3\frac{1}{8}$



WS45 $\frac{5}{16}$ x $3\frac{5}{16}$

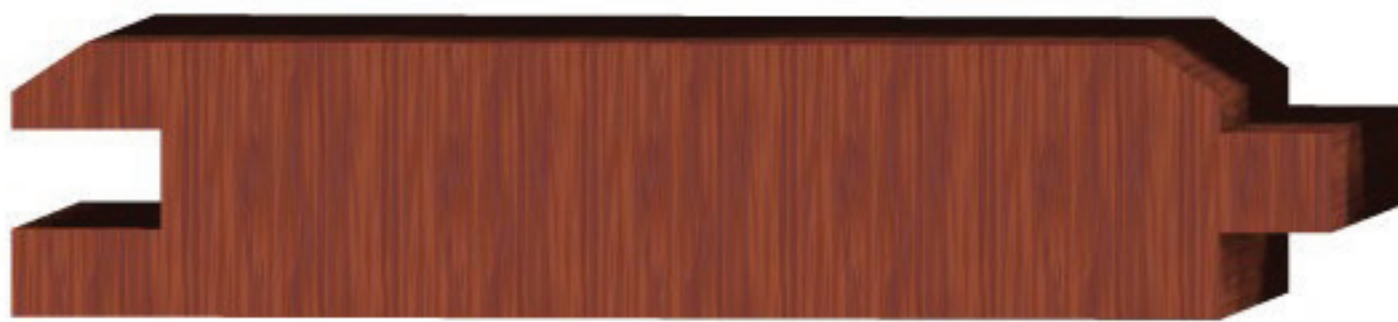

WS13 $\frac{11}{16}$ x $3\frac{5}{16}$



WS22 $\frac{11}{16}$ x $3\frac{7}{16}$

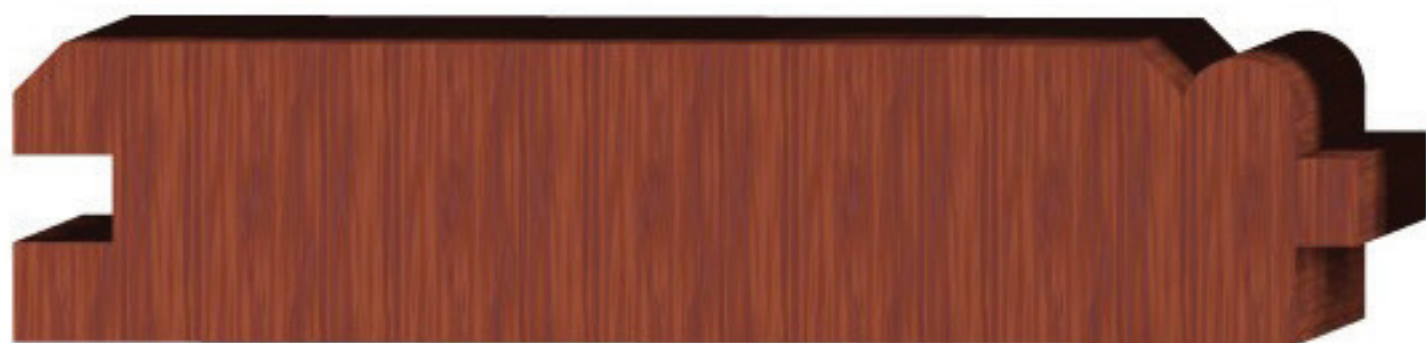

WS18 $\frac{3}{4}$ x $3\frac{3}{8}$

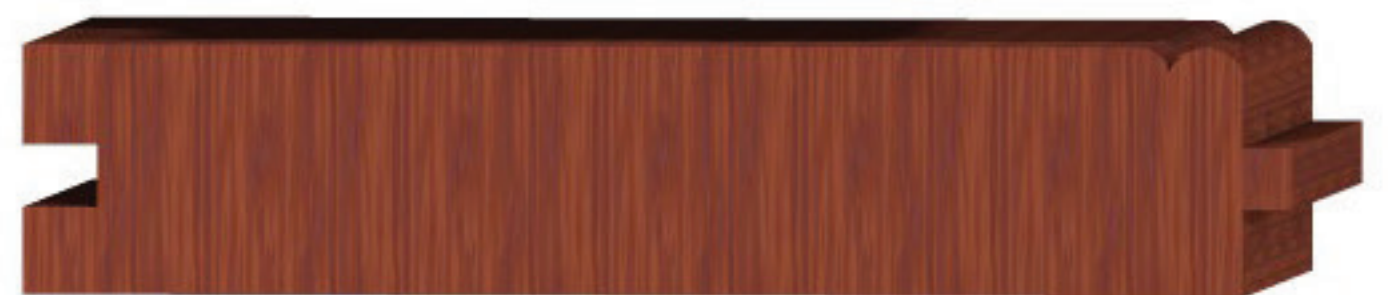

WS34 $\frac{5}{8}$ x $3\frac{3}{16}$



WS15 $\frac{3}{4}$ x $3\frac{9}{16}$

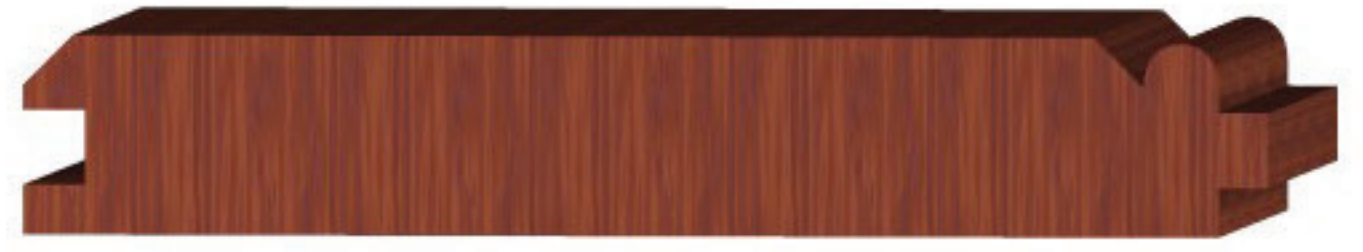

WS12 $\frac{1}{2}$ x $3\frac{1}{8}$



WS43 $\frac{5}{8}$ x 6 

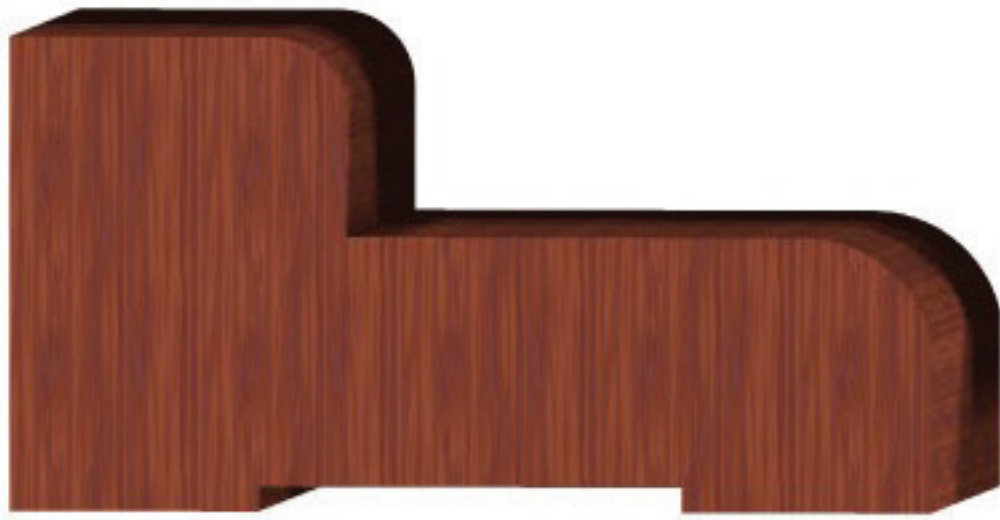

WS04 $1\frac{3}{16}$ x $2\frac{5}{16}$



WS14 $\frac{13}{16}$ x $2\frac{3}{16}$



WS31 $\frac{3}{4}$ x $2\frac{11}{16}$

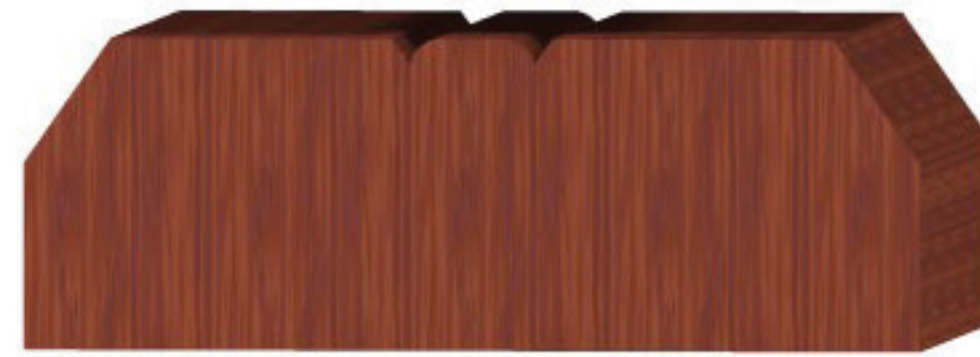

WS32 $\frac{13}{16}$ x $2\frac{1}{4}$

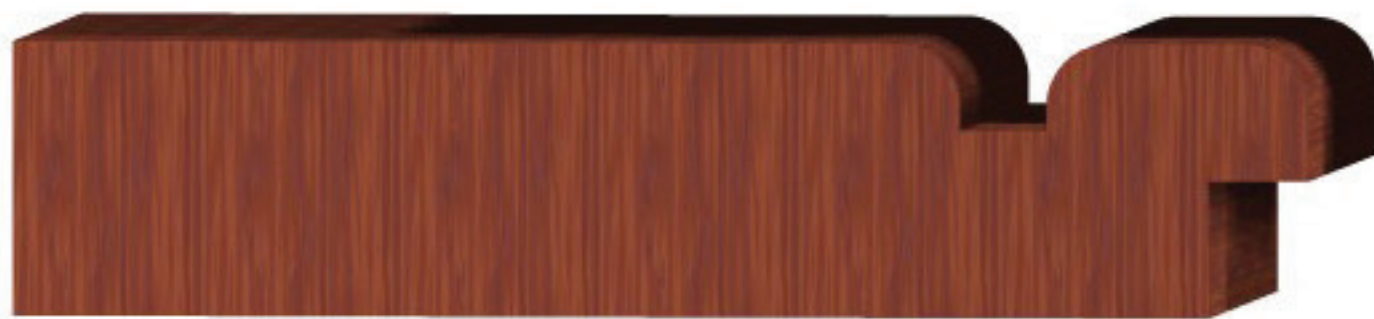

WS05 $\frac{11}{16}$ x $3\frac{1}{4}$



WS20 $\frac{13}{16}$ x $2\frac{7}{8}$



WS33 1/2 x 2-3/4



WS25 3/4 x 2-1/8

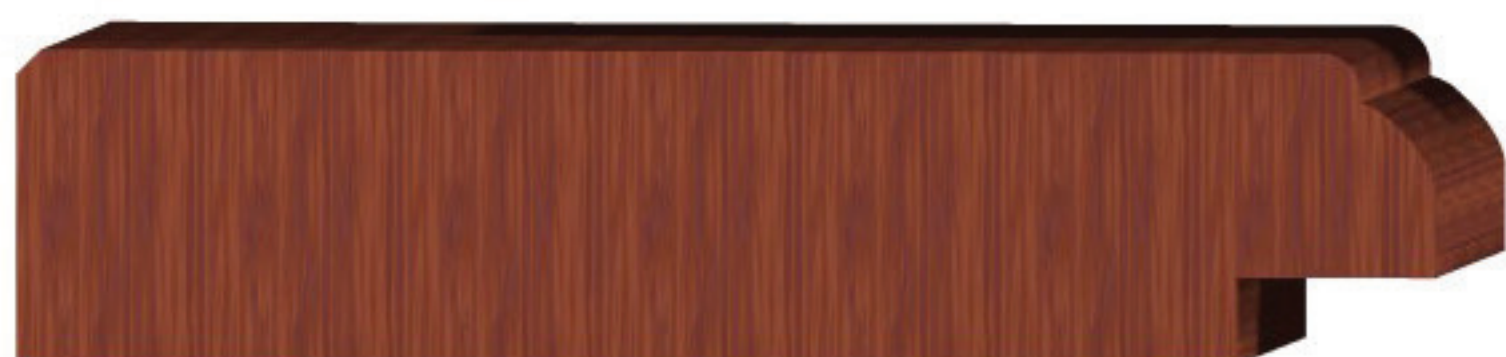

WS36 13/16 x 3-9/16



WS39 1/2 x 2-5/8



WS76 5/8 x 3-7/8



WS37 7/8 x 5-1/4



WS41 3/4 x 5-1/2



WS07 $11/16$ x $5-1/16$



WS08 $5/8$ x $4-3/8$



WS06 $7/8$ x $5-1/2$



WS35 $13/16$ x $5-3/8$



WS47 $7/8$ x $5-9/16$

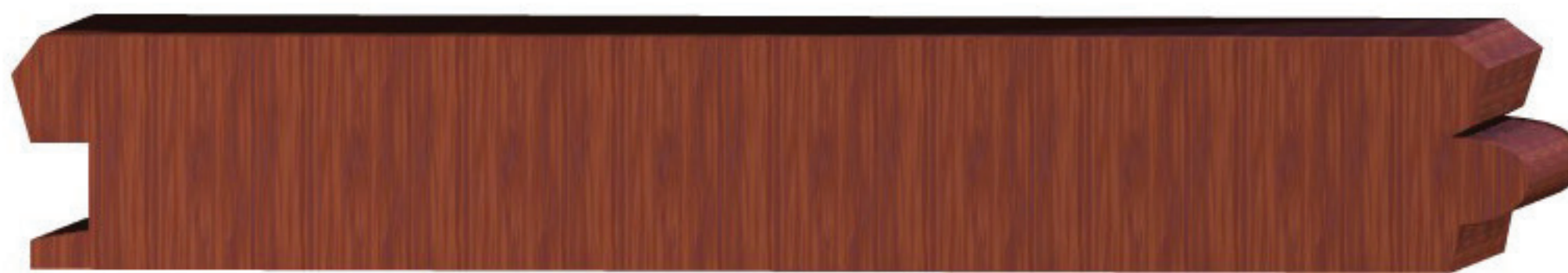

WS01 $3/4$ x $4-7/8$



WS48 $13/16$ x $7-1/2$

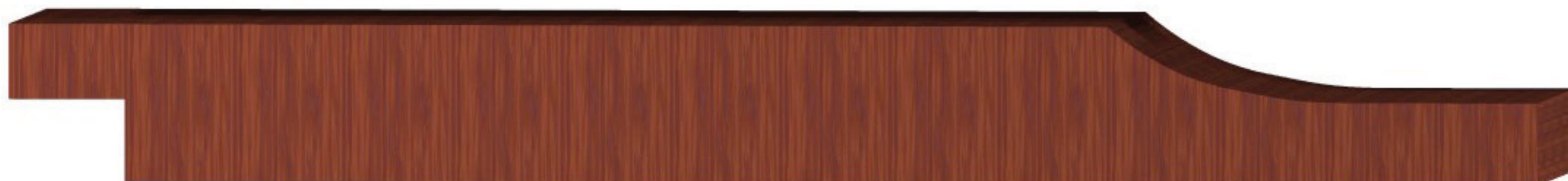

WS09 $3/4$ x 7



WS02 $3/4$ x $7-1/8$

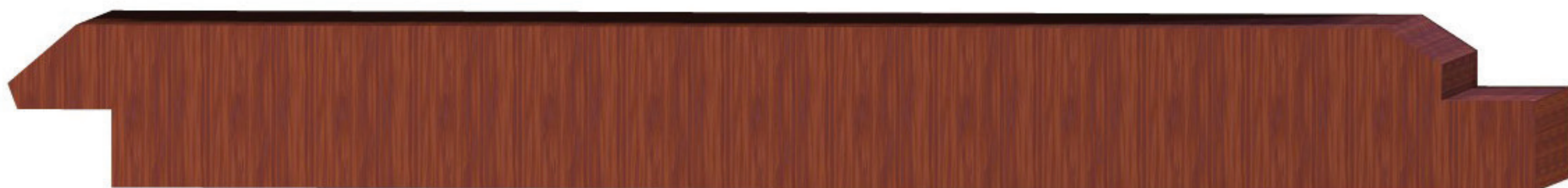

WS10 $13/16$ x $7-3/8$



WS28 $9/16$ x 6

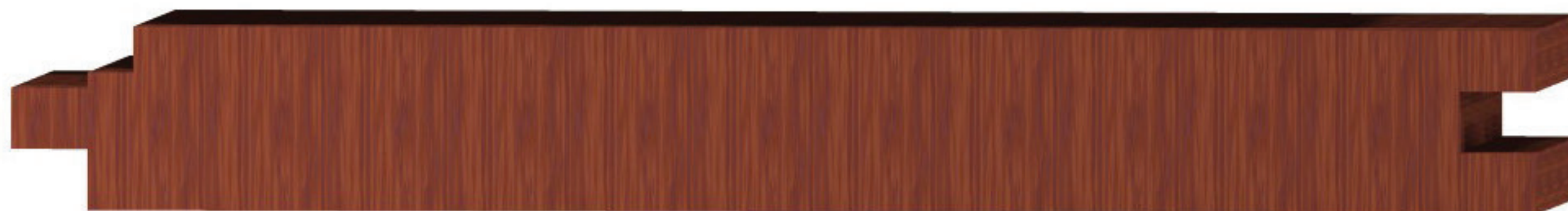

WS40 $3/4$ x $6-1/4$

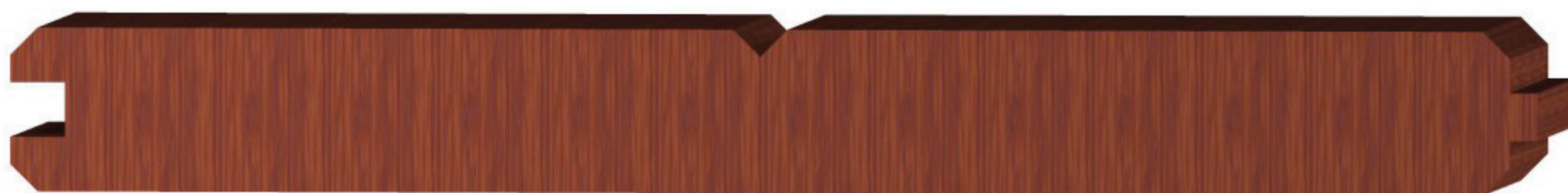

WS11 $\frac{3}{4}$ x 7

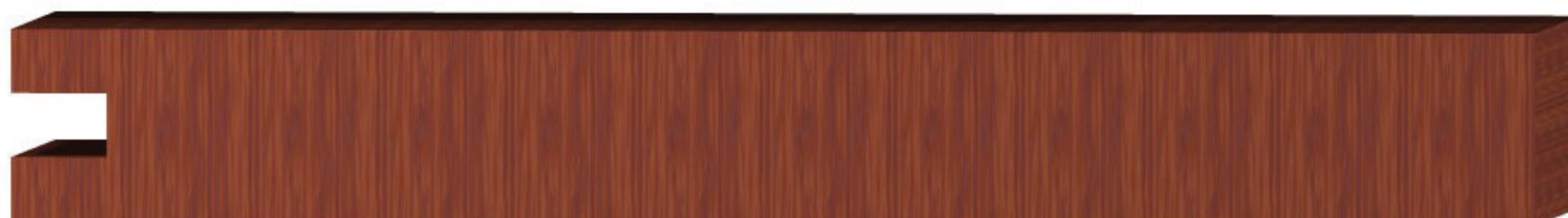

WS42 $\frac{3}{4}$ x $5\frac{15}{16}$

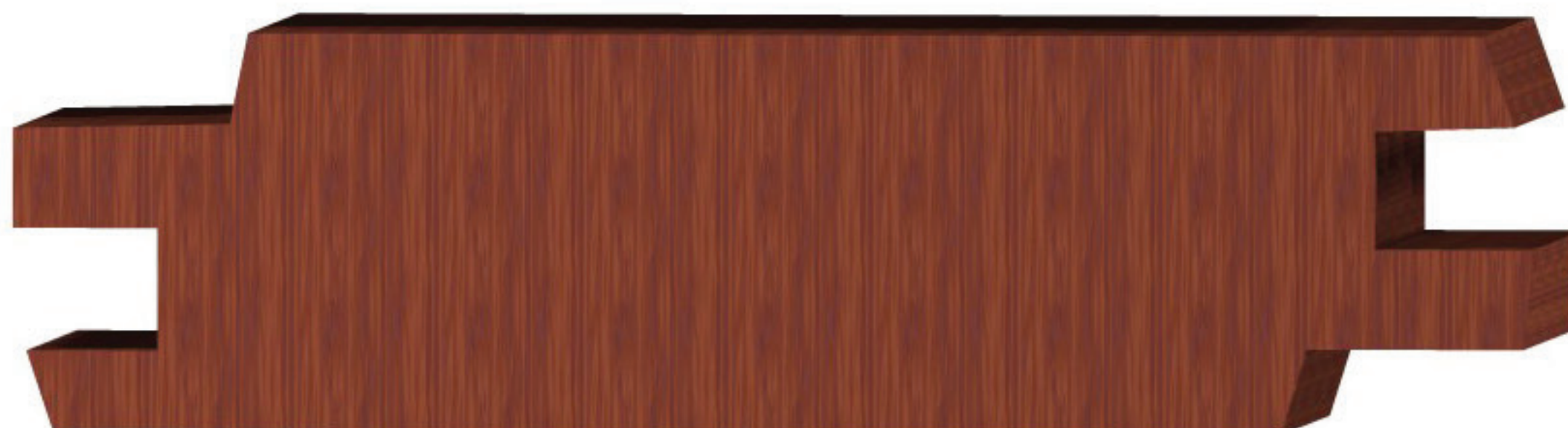

WS16 $1\frac{3}{8}$ x $5\frac{1}{4}$

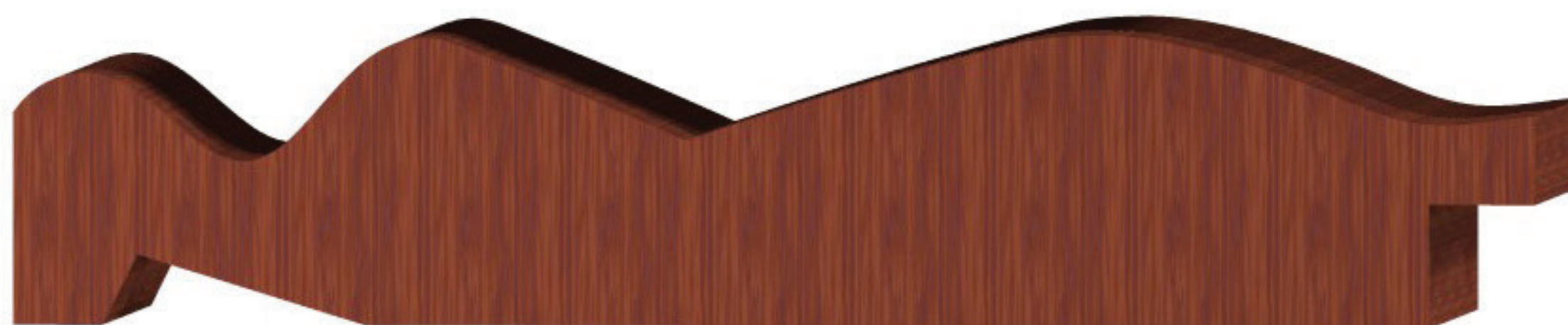



WS30 $1\frac{1}{16}$ x $5\frac{3}{8}$























































WS38 $1\frac{1}{2}$ x $7\frac{1}{2}$





































































WS44
11/16 x 9-1/8















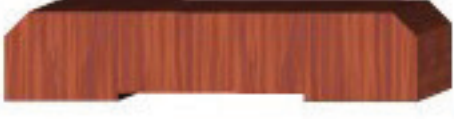

















<p>BA01 11/16 x 5-1/4</p>  <p>4</p>	<p>BA12 5/8 x 6-3/16</p>  <p>4</p>	<p>BA23 5/8 x 4-1/4</p>  <p>19</p>
<p>BA02 9/16 x 5-1/16</p>  <p>19</p>	<p>BA13 9/16 x 5-1/4</p>  <p>4</p>	<p>BA24 5/8 x 5-1/4</p>  <p>20</p>
<p>BA03 9/16 x 5</p>  <p>5</p>	<p>BA14 3/4 x 5-9/16</p>  <p>19</p>	<p>BA25 1/4 x 3-1/4</p>  <p>4</p>
<p>BA04 3/8 x 3-1/4</p>  <p>21</p>	<p>BA15 11/16 x 5-1/2</p>  <p>19</p>	<p>BA26 1/2 x 4</p>  <p>5</p>
<p>BA05 11/16 x 5-3/8</p>  <p>12</p>	<p>BA16 1 x 3-1/4</p>  <p>15</p>	<p>BA27 3/4 x 4</p>  <p>6</p>
<p>BA06 13/16 x 5-3/8</p>  <p>10</p>	<p>BA17 11/16 x 5-1/16</p>  <p>19</p>	<p>BA28 1/2 x 3</p>  <p>8</p>
<p>BA07 1 x 4-5/8</p>  <p>17</p>	<p>BA18 13/16 x 5-1/2</p>  <p>5</p>	<p>BA29 5/16 x 2-1/4</p>  <p>21</p>
<p>BA08 9/16 x 4-1/4</p>  <p>13</p>	<p>BA19 9/16 x 4-3/8</p>  <p>15</p>	<p>BA30 9/16 x 3-5/16</p>  <p>21</p>
<p>BA09 9/16 x 4-1/4</p>  <p>3</p>	<p>BA20 5/16 x 3-1/4</p>  <p>5</p>	<p>BA31 3/8 x 2-3/16</p>  <p>4</p>
<p>BA10 1-1/8 x 4-5/8</p>  <p>17</p>	<p>BA21 11/16 x 4-7/16</p>  <p>14</p>	<p>BA32 13/16 x 7-9/16</p>  <p>3</p>
<p>BA11 3/4 x 2</p>  <p>8</p>	<p>BA22 3/4 x 4-1/2</p>  <p>10</p>	<p>BA33 1 x 7-1/8</p>  <p>18</p>



















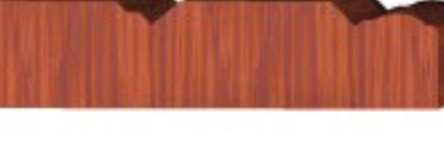











<p>BA34 11/16 x 3-1/4</p>  <p>15</p>	<p>BA45 1/2 x 5-1/4</p>  <p>14</p>	<p>BA56 5/8 x 4-5/8</p>  <p>13</p>
<p>BA35 7/16 x 2-3/4</p>  <p>21</p>	<p>BA46 3/4 x 4-1/8</p>  <p>15</p>	<p>BA57 5/8 x 4-1/4</p>  <p>14</p>
<p>BA36 11/16 x 5-1/4</p>  <p>7</p>	<p>BA47 1/2 x 5</p>  <p>20</p>	<p>BA58 9/16 x 5-1/4</p>  <p>9</p>
<p>BA37 11/16 x 3-1/4</p>  <p>15</p>	<p>BA48 9/16 x 7-1/4</p>  <p>16</p>	<p>BA59 5/8 x 5-1/4</p>  <p>17</p>
<p>BA38 3/8 x 2-1/2</p>  <p>15</p>	<p>BA49 13/16 x 7-1/4</p>  <p>11</p>	<p>BA60 3/4 x 6-1/16</p>  <p>16</p>
<p>BA39 9/16 x 5-3/16</p>  <p>21</p>	<p>BA50 11/16 x 7-3/16</p>  <p>11</p>	<p>BA61 9/16 x 4-5/16</p>  <p>9</p>
<p>BA40 9/16 x 5-1/8</p>  <p>14</p>	<p>BA51 9/16 x 3-11/16</p>  <p>8</p>	<p>BA62 3/4 x 2-3/4</p>  <p>15</p>
<p>BA41 9/16 x 5-5/16</p>  <p>10</p>	<p>BA52 13/16 x 6</p>  <p>7</p>	<p>BA63 3/4 x 5-15/16</p>  <p>17</p>
<p>BA42 3/4 x 5-5/16</p>  <p>9</p>	<p>BA53 1/2 x 3-1/4</p>  <p>21</p>	<p>BA64 3/4 x 7-1/4</p>  <p>18</p>
<p>BA43 3/4 x 5-1/16</p>  <p>10</p>	<p>BA54 9/16 x 2-1/4</p>  <p>8</p>	<p>BA65 5/8 x 4</p>  <p>6</p>
<p>BA44 5/16 x 3-1/4</p>  <p>8</p>	<p>BA55 5/8 x 7</p>  <p>7</p>	<p>BA66 3/4 x 2-1/8</p>  <p>8</p>





<p>BA67 5/8 x 2-1/4</p>  <p>8</p>	<p>BA78 3/8 x 3-1/4</p>  <p>21</p>	<p>BA89 7/8 x 5-7/16</p>  <p>13</p>
<p>BA68 11/16 x 3-11/16</p>  <p>15</p>	<p>BA79 11/16 x 5</p>  <p>6</p>	<p>BA90 3/4 x 4-7/8</p>  <p>3</p>
<p>BA69 3/4 x 5-9/16</p>  <p>12</p>	<p>BA80 3/4 x 5-1/2</p>  <p>16</p>	<p>BA91 5/16 x 1-15/16</p>  <p>8</p>
<p>BA70 11/16 x 4-1/2</p>  <p>10</p>	<p>BA81 11/16 x 5-1/4</p>  <p>12</p>	<p>BA92 3/4 x 6-7/16</p>  <p>3</p>
<p>BA71 1-3/16 x 5</p>  <p>10</p>	<p>BA82 1/2 x 5-3/4</p>  <p>5</p>	<p>BA93 13/16 x 5-3/4</p>  <p>18</p>
<p>BA72 9/16 x 4-3/8</p>  <p>14</p>	<p>BA83 3/4 x 3-1/2</p>  <p>6</p>	<p>BA94 13/16 x 5-15/16</p>  <p>6</p>
<p>BA73 9/16 x 6-1/8</p>  <p>9</p>	<p>BA84 3/4 x 8</p>  <p>3</p>	<p>BA95 11/16 x 8-15/16</p>  <p>3</p>
<p>BA74 9/16 x 4-1/2</p>  <p>15</p>	<p>BA85 3/4 x up to 10"</p>  <p>16</p>	<p>BA96 11/16 x 7-15/16</p>  <p>20</p>
<p>BA75 3/4 x 6</p>  <p>12</p>	<p>BA86 5/8 x 7-1/4</p>  <p>11</p>	<p>BA97 3/4 x 7</p>  <p>7</p>
<p>BA76 1/2 x 3-1/4</p>  <p>8</p>	<p>BA87 11/16 x 5-1/4</p>  <p>13</p>	<p>BA99 11/16 x 8</p>  <p>11</p>
<p>BA77 11/16 x 6</p>  <p>9</p>	<p>BA88 3/8 x 3</p>  <p>8</p>	<p>BA100 1 x 6</p>  <p>18</p>

<p>BA100 1 x 6</p>  <p>18</p>	<p>CA05 3/4 x 3</p>  <p>101</p>	<p>CA16 13/16 x 2-3/4</p>  <p>90</p>
<p>BA101 13/16 x 5-1/8</p>  <p>20</p>	<p>CA06 3/4 x 1-3/4</p>  <p>82</p>	<p>CA17 11/16 x 2-3/4</p>  <p>78</p>
<p>BA102 11/16 x 5-1/4</p>  <p>12</p>	<p>CA07 3/4 x 7-5/16</p>  <p>96</p>	<p>CA18 11/16 x 2-1/2</p>  <p>81</p>
<p>BA104 5/8 x 7-5/16</p>  <p>20</p>	<p>CA08 11/16 x 4-1/4</p>  <p>83</p>	<p>CA19 13/16 x 5-5/16</p>  <p>96</p>
<p>BA105 9/16 x 7-1/4</p>  <p>11</p>	<p>CA09 11/16 x 3-1/2</p>  <p>78</p>	<p>CA20 1 x 5-1/4</p>  <p>92</p>
<p>BA106 9/16 x 1-1/2</p>  <p>15</p>	<p>CA10 5/8 x 2-1/4</p>  <p>88</p>	<p>CA21 11/16 x 2-1/4</p>  <p>97</p>
<p>BA107 3/4 x 6</p>  <p>7</p>	<p>CA11 7/16 x 5</p>  <p>101</p>	<p>CA22 11/16 x 4-3/16</p>  <p>95</p>
<p>CA01 1 x 5-1/2</p>  <p>84</p>	<p>CA12 13/16 x 5-5/8</p>  <p>97</p>	<p>CA23 3/4 x 3-1/4</p>  <p>95</p>
<p>CA02 3/4 x 3-1/4</p>  <p>87</p>	<p>CA13 1-1/8 x 7-3/4</p>  <p>101</p>	<p>CA24 11/16 x 2-3/8</p>  <p>92</p>
<p>CA03 11/16 x 2-3/8</p>  <p>87</p>	<p>CA14 11/16 x 3-1/4</p>  <p>99</p>	<p>CA25 5/8 x 3-5/16</p>  <p>98</p>
<p>CA04 1-3/16 x 4-15/16</p>  <p>85</p>	<p>CA15 3/4 x 2-1/16</p>  <p>89</p>	<p>CA26 11/16 x 2-1/2</p>  <p>92</p>















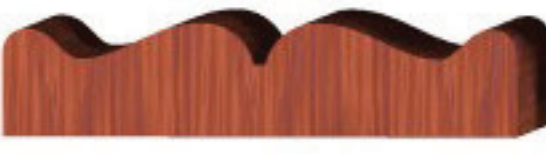

















<p>CA27 3/4 x 3-1/4</p>  <p>81</p>	<p>CA38 3/4 x 2-11/16</p>  <p>79</p>	<p>CA49 3/4 x 3-1/2</p>  <p>82</p>
<p>CA28 3/4 x 5-1/2</p>  <p>100</p>	<p>CA39 13/16 x 2-7/16</p>  <p>79</p>	<p>CA50 3/4 x 2-1/2</p>  <p>92</p>
<p>CA29 3/4 x 5-3/16</p>  <p>96</p>	<p>CA40 3/4 x 4-3/8</p>  <p>95</p>	<p>CA51 3/4 x 3-1/4</p>  <p>95</p>
<p>CA30 3/4 x 1-3/4</p>  <p>98</p>	<p>CA41 3/4 x 4-3/8</p>  <p>95</p>	<p>CA52 1 x 3-1/4</p>  <p>87</p>
<p>CA31 3/4 x 2-1/4</p>  <p>92</p>	<p>CA42 9/16 x 1-5/8</p>  <p>88</p>	<p>CA53 5/8 x 2-1/2</p>  <p>98</p>
<p>CA32 1-1/8 x 3-9/16</p>  <p>85</p>	<p>CA43 9/16 x 2-1/4</p>  <p>93</p>	<p>CA54 1/2 x 1-9/16</p>  <p>93</p>
<p>CA33 13/16 x 2-1/2</p>  <p>89</p>	<p>CA44 3/4 x 2-1/4</p>  <p>81</p>	<p>CA55 3/4 x 4-1/16</p>  <p>97</p>
<p>CA34 1-7/16 x 2</p>  <p>81</p>	<p>CA45 3/4 x 4</p>  <p>101</p>	<p>CA56 11/16 x 1-11/16</p>  <p>82</p>
<p>CA35 5/8 x 3-3/16</p>  <p>82</p>	<p>CA46 3/4 x 2-9/16</p>  <p>89</p>	<p>CA57 1-1/16 x 3-1/2</p>  <p>79</p>
<p>CA36 3/4 x 1-3/4</p>  <p>81</p>	<p>CA47 5/8 x 3-1/4</p>  <p>88</p>	<p>CA58 1-3/16 x 5</p>  <p>87</p>
<p>CA37 3/4 x 3</p>  <p>78</p>	<p>CA48 11/16 x 3-3/8</p>  <p>93</p>	<p>CA59 11/16 x 2-3/4</p>  <p>95</p>



















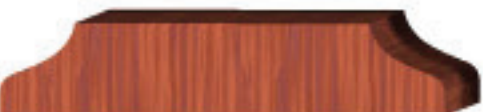













<p>CA60 1-1/8 x 4-1/8</p>  <p>86</p>	<p>CA71 5/8 x 3-9/16</p>  <p>79</p>	<p>CA82 1-7/8 x 2-1/2</p>  <p>90</p>
<p>CA61 3/4 x 3-1/2</p>  <p>100</p>	<p>CA72 13/16 x 1-7/8</p>  <p>89</p>	<p>CA83 11/16 x 3-3/16</p>  <p>77</p>
<p>CA62 9/16 x 3-1/16</p>  <p>78</p>	<p>CA73 5/8 x 1-13/16</p>  <p>81</p>	<p>CA84 9/16 x 4-1/16</p>  <p>97</p>
<p>CA63 1-1/8 x 3-1/2</p>  <p>84</p>	<p>CA74 1-9/16 x 3-1/16</p>  <p>80</p>	<p>CA85 1-7/16 x 5-1/8</p>  <p>86</p>
<p>CA64 1-1/2 x 2-1/2</p>  <p>80</p>	<p>CA75 3/8 x 2-3/8</p>  <p>98</p>	<p>CA86 13/16 x 5-1/2</p>  <p>98</p>
<p>CA65 3/4 x 3-1/4</p>  <p>77</p>	<p>CA76 1-1/4 x 2-11/16</p>  <p>80</p>	<p>CA87 3/4 x 2-11/16</p>  <p>81</p>
<p>CA66 11/16 x 4-1/4</p>  <p>84</p>	<p>CA77 3/4 x 2-1/8</p>  <p>89</p>	<p>CA88 1-3/8 x 2-1/2</p>  <p>80</p>
<p>CA67 7/8 x 3-1/16</p>  <p>94</p>	<p>CA78 11/16 x 2-5/16</p>  <p>77</p>	<p>CA89 1-1/8 x 3-7/16</p>  <p>80</p>
<p>CA68 1-1/16 x 3-3/8</p>  <p>92</p>	<p>CA79 3/4 x 2-7/8</p>  <p>89</p>	<p>CA90 3/4 x 2-13/16</p>  <p>89</p>
<p>CA69 11/16 x 4-1/16</p>  <p>91</p>	<p>CA80 3/4 x 3-9/16</p>  <p>92</p>	<p>CA91 3/4 x 3-1/4</p>  <p>95</p>
<p>CA70 3/4 x 5-1/2</p>  <p>93</p>	<p>CA81 1/2 x 2-3/4</p>  <p>97</p>	<p>CA92 1-1/4 x 5</p>  <p>101</p>

<p>CA93 13/16 x 2-3/4</p>  <p>78</p>	<p>CA105 1-1/16 x 3-3/8</p>  <p>91</p>	<p>CA116 11/16 x 2-1/2</p>  <p>92</p>
<p>CA94 3/4 x 2-5/16</p>  <p>81</p>	<p>CA106 1-1/4 x 3-5/16</p>  <p>85</p>	<p>CA117 13/16 x 3-1/4</p>  <p>77</p>
<p>CA95 3/4 x 1-3/4</p>  <p>82</p>	<p>CA107 11/16 x 2-5/16</p>  <p>88</p>	<p>CA118 3/4 x 3-3/8</p>  <p>88</p>
<p>CA97 3/4 x 3-5/16</p>  <p>100</p>	<p>CA108 1-1/8 x 4-13/16</p>  <p>77</p>	<p>CA119 3/4 x 3-3/8</p>  <p>82</p>
<p>CA98 3/4 x 1-1/2</p>  <p>89</p>	<p>CA109 1-3/4 x 4-5/8</p>  <p>86</p>	<p>CA120 3/4 x 3-3/8</p>  <p>92</p>
<p>CA99 1/2 x 2-3/8</p>  <p>95</p>	<p>CA110 11/16 x 2-7/16</p>  <p>92</p>	<p>CA121 3/4 x 4</p>  <p>82</p>
<p>CA100 1-1/8 x 2-1/8</p>  <p>80</p>	<p>CA111 3/4 x 2-1/2</p>  <p>79</p>	<p>CA122 11/16 x 3-1/16</p>  <p>94</p>
<p>CA101 15/16 x 2-1/2</p>  <p>91</p>	<p>CA112 5/8 x 2-5/8</p>  <p>88</p>	<p>CA123 13/16 x 5</p>  <p>78</p>
<p>CA102 7/8 x 2-1/16</p>  <p>91</p>	<p>CA113 1 x 5-1/16</p>  <p>87</p>	<p>CA124 11/16 x 5-1/16</p>  <p>94</p>
<p>CA103 1-1/4 x 1-11/16</p>  <p>91</p>	<p>CA114 13/16 x 3-9/16</p>  <p>89</p>	<p>CA125 3/4 x 5-5/16</p>  <p>100</p>
<p>CA104 1-3/4 x 4-1/8</p>  <p>85</p>	<p>CA115 5/8 x 2-1/2</p>  <p>78</p>	<p>CA126 9/16 x 2-1/4</p>  <p>98</p>











<p>CA127 1 x 3</p>  <p>82</p>	<p>CA138 1 x 4-1/16</p>  <p>87</p>	<p>CA151 3/4 x 4-3/8</p>  <p>83</p>
<p>CA128 3/4 x 5-1/2</p>  <p>96</p>	<p>CA139 3/4 x 2-1/4</p>  <p>88</p>	<p>CA152 3/4 x 3-1/16</p>  <p>83</p>
<p>CA129 3/4 x 2</p>  <p>90</p>	<p>CA140 13/16 x 3-1/2</p>  <p>81</p>	<p>CA153 3/4 x 3-5/8</p>  <p>84</p>
<p>CA130 3/4 x 2-11/16</p>  <p>82</p>	<p>CA141 3/8 x 2-1/4</p>  <p>98</p>	<p>CA154 3/4 x 3-7/16</p>  <p>83</p>
<p>CA131 11/16 x 3-1/2</p>  <p>91</p>	<p>CA142 1-1/4 x 3-1/2</p>  <p>80</p>	<p>CA155 3/4 x 2</p>  <p>90</p>
<p>CA132 13/16 x 5-5/16</p>  <p>78</p>	<p>CA143 3/4 x 3</p>  <p>99</p>	<p>CA156 3/4 x 2-5/16</p>  <p>90</p>
<p>CA133 3/4 x 3-1/16</p>  <p>95</p>	<p>CA144 13/16 x 2</p>  <p>89</p>	<p>CA157 11/16 x 4-1/2</p>  <p>98</p>
<p>CA134 3/4 x 3-9/16</p>  <p>83</p>	<p>CA145 1-3/8 x 4-1/2</p>  <p>86</p>	<p>CA158 1-3/4 x 10</p>  <p>102</p>
<p>CA135 3/4 x 4-1/4</p>  <p>99</p>	<p>CA147 3/4 x 3-1/2</p>  <p>94</p>	<p>CA159 11/16 x 3-1/4</p>  <p>91</p>
<p>CA136 3/4 x 3-3/8</p>  <p>93</p>	<p>CA148 3/4 x 2-11/16</p>  <p>82</p>	<p>CA160 1-7/16 x 3-3/8</p>  <p>85</p>
<p>CA137 3/4 x 6</p>  <p>99</p>	<p>CA150 1 x 5</p>  <p>100</p>	<p>CA161 3/4 x 2-1/2</p>  <p>88</p>

































<p>CA162 7/8 x 4-7/8</p>  <p>96</p>	<p>CA173 3/4 x 3</p>  <p>89</p>	<p>CA184 7/8 x 4</p>  <p>93</p>
<p>CA163 13/16 x 3-1/2</p>  <p>90</p>	<p>CA174 1-1/16 x 2-9/16</p>  <p>80</p>	<p>CA186 3/8 x 2-1/2</p>  <p>88</p>
<p>CA164 7/8 x 4-1/4</p>  <p>77</p>	<p>CA175 5/8 x 2-9/16</p>  <p>98</p>	<p>CA187 5/8 x 1-9/16</p>  <p>93</p>
<p>CA165 11/16 x 2-5/16</p>  <p>89</p>	<p>CA176 5/8 x 2-1/4</p>  <p>90</p>	<p>CA188 3/4 x 2-1/4</p>  <p>90</p>
<p>CA166 1-3/8 x 3-5/16</p>  <p>85</p>	<p>CA177 3/4 x 15/16</p>  <p>80</p>	<p>CA189 9/16 x 4-1/4</p>  <p>94</p>
<p>CA167 3/4 x 3-7/16</p>  <p>97</p>	<p>CA178 1-3/16 x 4-1/2</p>  <p>87</p>	<p>CA190 9/16 x 1-5/8</p>  <p>89</p>
<p>CA168 1 x 3-3/16</p>  <p>90</p>	<p>CA179 3/4 x 4-7/16</p>  <p>94</p>	<p>CA191 3/4 x 3-1/4</p>  <p>83</p>
<p>CA169 3/4 x 2-9/16</p>  <p>90</p>	<p>CA180 5/8 x 3-3/16</p>  <p>89</p>	<p>CA192 13/16 x 4-1/2</p>  <p>84</p>
<p>CA170 5/8 x 3-3/16</p>  <p>90</p>	<p>CA181 1-1/8 x 4-1/2</p>  <p>79</p>	<p>CA193 3/4 x 4-7/16</p>  <p>83</p>
<p>CA171 1-3/8 x 3-7/16</p>  <p>79</p>	<p>CA182 1-1/8 x 3-3/8</p>  <p>79</p>	<p>CA194 11/16 x 3</p>  <p>93</p>
<p>CA172 3/4 x 3-5/8</p>  <p>83</p>	<p>CA183 3/4 x 3-3/8</p>  <p>88</p>	<p>CA195 1-1/16 x 3-1/2</p>  <p>83</p>

<p>CA196 1-1/4 x 6</p>  <p>77</p>	<p>CH02 1/2 x 2</p>  <p>23</p>	<p>CH13 11/16 x 2-5/8</p>  <p>25</p>
<p>CA197 1-3/8 x 2-5/16</p>  <p>91</p>	<p>CH03 5/8 x 2-11/16</p>  <p>23</p>	<p>CH14 1/2 x 2-3/4</p>  <p>23</p>
<p>CA198 5/8 x 2-1/2</p>  <p>90</p>	<p>CH04 3/4 x 2</p>  <p>25</p>	<p>CH15 1/2 x 2-1/4</p>  <p>24</p>
<p>CA199 13/16 x 5-7/16</p>  <p>84</p>	<p>CH05 3/4 x 1-1/4</p>  <p>26</p>	<p>CH16 7/16 x 1-3/4</p>  <p>23</p>
<p>CA200 1-1/8 x 4-1/8</p>  <p>103</p>	<p>CH06 13/16 x 2-1/4</p>  <p>26</p>	<p>CH17 13/16 x 2-1/4</p>  <p>25</p>
<p>CA201 3/4 x 4-1/4</p>  <p>103</p>	<p>CH07 1-1/8 x 2-1/2</p>  <p>25</p>	<p>CH18 1-1/16 x 3-1/16</p>  <p>25</p>
<p>CA202 3/4 x 3</p>  <p>103</p>	<p>CH08 7/16 x 2-1/4</p>  <p>23</p>	<p>CH19 11/16 x 1-5/8</p>  <p>25</p>
<p>CA203 13/16 x 2-7/16</p>  <p>103</p>	<p>CH09 11/16 x 2-1/4</p>  <p>25</p>	<p>CH20 3/4 x 2-3/16</p>  <p>25</p>
<p>CA204 13/16 x 3-1/16</p>  <p>103</p>	<p>CH10 1/2 x 2-3/4</p>  <p>23</p>	<p>CH21 7/8 x 2-1/8</p>  <p>26</p>
<p>CA207 3/4 x 2-5/16</p>  <p>103</p>	<p>CH11 11/16 x 3</p>  <p>25</p>	<p>CH22 5/16 x 1-1/8</p>  <p>26</p>
<p>CH01 15/16 x 3</p>  <p>25</p>	<p>CH12 13/16 x 3-1/2</p>  <p>26</p>	<p>CH23 3/4 x 1-1/2</p>  <p>25</p>

<p>CH24 11/16 x 2-3/8</p>  <p>26</p>	<p>CH35 3/4 x 1-1/2</p>  <p>23</p>	<p>CR02 3/4 x 3-5/16</p>  <p>66</p>
<p>CH25 3/4 x 3</p>  <p>26</p>	<p>CH37 7/16 x 1-1/2</p>  <p>24</p>	<p>CR03 7/8 x 5-1/2</p>  <p>50</p>
<p>CH26 13/16 x 4-1/2</p>  <p>24</p>	<p>CH38 11/16 x 1-1/2</p>  <p>24</p>	<p>CR04 1-1/4 x 6</p>  <p>45</p>
<p>CH27 3/4 x 3</p>  <p>24</p>	<p>CH39 1/2 x 2</p>  <p>23</p>	<p>CR05 11/16 x 1-9/16</p>  <p>37</p>
<p>CH28 3/8 x 2-5/16</p>  <p>24</p>	<p>CH40 5/8 x 4-3/16</p>  <p>26</p>	<p>CR06 3/4 x 1-1/16</p>  <p>37</p>
<p>CH29 11/16 x 3</p>  <p>23</p>	<p>CH42 7/16 x 2-5/16</p>  <p>24</p>	<p>CR07 1-1/4 x 2-3/16</p>  <p>38</p>
<p>CH30 3/4 x 1-1/2</p>  <p>24</p>	<p>CH43 3/4 x 3-1/2</p>  <p>24</p>	<p>CR08 7/8 x 4-1/4</p>  <p>66</p>
<p>CH31 11/16 x 3-1/4</p>  <p>26</p>	<p>CH44 3/4 x 2-1/4</p>  <p>26</p>	<p>CR09 7/8 x 1-1/8</p>  <p>37</p>
<p>CH32 13/16 x 5-1/8</p>  <p>23</p>	<p>CH45 7/16 x 1-3/8</p>  <p>23</p>	<p>CR10 3/4 x 1-1/2</p>  <p>37</p>
<p>CH33 3/4 x 3-1/2</p>  <p>26</p>	<p>CH46 3/4 x 2-3/4</p>  <p>25</p>	<p>CR11 3/4 x 4-1/4</p>  <p>30</p>
<p>CH34 1 x 3-1/8</p>  <p>26</p>	<p>CR01 3/4 x 4-1/2</p>  <p>70</p>	<p>CR12 5/8 x 3-5/16</p>  <p>70</p>





















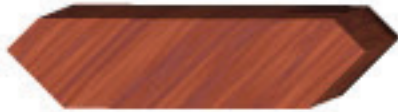











<p>CR13 3/4 x 1-1/16</p>  <p>37</p>	<p>CR24 11/16 x 3-5/8</p>  <p>60</p>	<p>CR35 7/8 x 6</p>  <p>46</p>
<p>CR14 1 x 1-3/4</p>  <p>37</p>	<p>CR25 9/16 x 2</p>  <p>43</p>	<p>CR36 7/8 x 5-13/16</p>  <p>67</p>
<p>CR15 3/4 x 1-1/16</p>  <p>37</p>	<p>CR26 1-3/4 x 2-7/8</p>  <p>38</p>	<p>CR37 3/4 x 1-13/16</p>  <p>47</p>
<p>CR16 1-11/16 x 1-11/16</p>  <p>39</p>	<p>CR27 5/8 x 2-3/4</p>  <p>31</p>	<p>CR38 3/4 x 5-9/16</p>  <p>67</p>
<p>CR17 1-1/4 x 2</p>  <p>37</p>	<p>CR28 3/4 x 4-1/2</p>  <p>30</p>	<p>CR39 5/8 x 5-1/16</p>  <p>70</p>
<p>CR18 3/4 x 1-1/16</p>  <p>37</p>	<p>CR29 3/4 x 4-1/16</p>  <p>35</p>	<p>CR40 3/4 x 3-13/16</p>  <p>50</p>
<p>CR19 3/4 x 1-1/2</p>  <p>37</p>	<p>CR30 3/4 x 5-1/8</p>  <p>30</p>	<p>CR41 1-3/8 x 5-3/4</p>  <p>41</p>
<p>CR20 11/16 x 4-1/8</p>  <p>45</p>	<p>CR31 3/4 x 3-5/8</p>  <p>36</p>	<p>CR42 3/4 x 4-15/16</p>  <p>45</p>
<p>CR21 5/8 x 7/8</p>  <p>37</p>	<p>CR32 3/4 x 2-1/2</p>  <p>43</p>	<p>CR43 3/4 x 3-3/16</p>  <p>45</p>
<p>CR22 1-1/2 x 3-1/4</p>  <p>38</p>	<p>CR33 5/8 x 2-1/4</p>  <p>31</p>	<p>CR44 1-1/16 x 4-1/4</p>  <p>43</p>
<p>CR23 11/16 x 3-1/4</p>  <p>45</p>	<p>CR34 7/8 x 5-5/16</p>  <p>56</p>	<p>CR45 3/4 x 3-1/2</p>  <p>54</p>

















<p>CR46 5/8 x 15/16</p>  <p>50</p>	<p>CR57 5/8 x 1-3/4</p>  <p>31</p>	<p>CR68 3/4 x 7- 1/2</p>  <p>32</p>
<p>CR47 5/8 x 3-1/4</p>  <p>31</p>	<p>CR58 5/8 x 2-1/4</p>  <p>41</p>	<p>CR69 13/16 x 6-1/8</p>  <p>46</p>
<p>CR48 5/8 x 2-5/8</p>  <p>54</p>	<p>CR59 15/16 x 1-5/8</p>  <p>37</p>	<p>CR70 7/8 x 6-1/2</p>  <p>64</p>
<p>CR49 9/16 x 1-13/16</p>  <p>54</p>	<p>CR60 3/4 x 4-1/8</p>  <p>43</p>	<p>CR71 3/4 x 4-3/4</p>  <p>56</p>
<p>CR50 1-1/16 x 5-5/16</p>  <p>60</p>	<p>CR61 15/16 x 1-13/16</p>  <p>37</p>	<p>CR72 13/16 x 6-1/4</p>  <p>68</p>
<p>CR51 3/4 x 5-3/8</p>  <p>33</p>	<p>CR62 3/4 x 5/8</p>  <p>50</p>	<p>CR73 13/16 x 6</p>  <p>51</p>
<p>CR52 3/4 x 5-3/4</p>  <p>35</p>	<p>CR63 11/16 x 4-1/2</p>  <p>67</p>	<p>CR74 7/8 x 1-7/16</p>  <p>55</p>
<p>CR53 1-5/16 x 7</p>  <p>32</p>	<p>CR64 1/2 x 2-9/16</p>  <p>36</p>	<p>CR75 3/4 x 3-3/4</p>  <p>60</p>
<p>CR54 7/8 x 2-1/4</p>  <p>62</p>	<p>CR65 3/4 x 1-11/16</p>  <p>55</p>	<p>CR76 1/2 x 3-1/16</p>  <p>47</p>
<p>CR55 1/2 x 2-1/4</p>  <p>55</p>	<p>CR66 1-1/2 x 4-1/16</p>  <p>63</p>	<p>CR77 1/4 x 5-3/8</p>  <p>60</p>
<p>CR56 11/16 x 3-3/8</p>  <p>36</p>	<p>CR67 1-5/16 x 5-1/2</p>  <p>42</p>	<p>CR78 3/4 x 6-1/2</p>  <p>71</p>

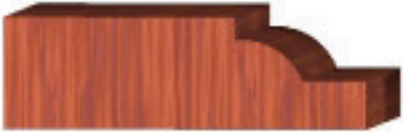

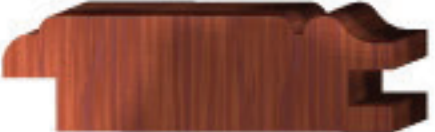



























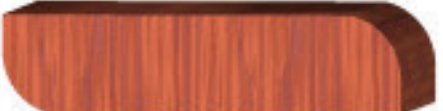

<p>CR79 3/4 x 6-1/2</p>  <p>67</p>	<p>CR90 1-11/16 x 7</p>  <p>47</p>	<p>CR101 1-3/8 x 7</p>  <p>69</p>
<p>CR80 1-3/8 x 4-11/16</p>  <p>41</p>	<p>CR91 1-1/16 x 5-9/16</p>  <p>47</p>	<p>CR102 1 x 5-3/16</p>  <p>73</p>
<p>CR81 7/8 x 3-11/16</p>  <p>56</p>	<p>CR92 11/16 x 5-3/16</p>  <p>50</p>	<p>CR103 1-5/8 x 1-5/8</p>  <p>40</p>
<p>CR82 1-1/16 x 2-3/16</p>  <p>38</p>	<p>CR93 9/16 x 4-3/16</p>  <p>56</p>	<p>CR104 1/8 x 6-9/16</p>  <p>57</p>
<p>CR83 7/8 x 6-5/16</p>  <p>35</p>	<p>CR94 3/4 x 4-7/8</p>  <p>68</p>	<p>CR105 1-1/4 x 5-3/8</p>  <p>61</p>
<p>CR84 13/16 x 5</p>  <p>57</p>	<p>CR95 3/4 x 3-9/16</p>  <p>42</p>	<p>CR106 3/4 x 3-1/2</p>  <p>62</p>
<p>CR85 1-1/16 x 5-7/16</p>  <p>31</p>	<p>CR96 5/8 x 3-1/8</p>  <p>56</p>	<p>CR107 3/4 x 4-13/16</p>  <p>61</p>
<p>CR86 3/4 x 3-3/4</p>  <p>50</p>	<p>CR97 3/4 x 2-1/4</p>  <p>42</p>	<p>CR109 3/4 x 3-1/2</p>  <p>47</p>
<p>CR87 13/16 x 6</p>  <p>48</p>	<p>CR98 1-3/4 x 2</p>  <p>40</p>	<p>CR111 3/4 x 3-3/4</p>  <p>61</p>
<p>CR88 3/4 x 3-9/16</p>  <p>51</p>	<p>CR99 1/2 x 2</p>  <p>41</p>	<p>CR113 9/16 x 3-5/16</p>  <p>70</p>
<p>CR89 3-1/16 x 4-3/16</p>  <p>70</p>	<p>CR100 1-1/4 x 7-5/8</p>  <p>69</p>	<p>CR114 3/4 x 5-9/16</p>  <p>47</p>

































<p>CR115 1-3/16 x 3</p>  <p>54</p>	<p>CR128 3/4 x 3-1/4</p>  <p>54</p>	<p>CR140 1-3/8 x 3-7/8</p>  <p>43</p>
<p>CR116 13/16 x 3-5/16</p>  <p>31</p>	<p>CR129 3/4 x 3-1/4</p>  <p>51</p>	<p>CR141 3/4 x 2-1/8</p>  <p>58</p>
<p>CR117 13/16 x 3</p>  <p>55</p>	<p>CR130 1-1/4 x 6-5/8</p>  <p>49</p>	<p>CR142 3/4 x 5-3/4</p>  <p>44</p>
<p>CR120 3/4 x 3-13/16</p>  <p>36</p>	<p>CR131 1/4 x 4-1/4</p>  <p>68</p>	<p>CR143 1/2 x 5/8</p>  <p>73</p>
<p>CR121 3/4 x 2-1/2</p>  <p>51</p>	<p>CR132 5/8 x 4-9/16</p>  <p>33</p>	<p>CR144 5/8 x 5/8</p>  <p>73</p>
<p>CR122 3/4 x 2-15/16</p>  <p>73</p>	<p>CR133 3/4 x 5-7/16</p>  <p>31</p>	<p>CR145 1/2 x 5/8</p>  <p>73</p>
<p>CR123 13/16 x 3-15/16</p>  <p>54</p>	<p>CR134 1/2 x 3-1/16</p>  <p>45</p>	<p>CR146 5/8 x 2-7/8</p>  <p>65</p>
<p>CR124 3/4 x 2-1/2</p>  <p>51</p>	<p>CR135 3/4 x 4-11/16</p>  <p>64</p>	<p>CR147 1-1/8 x 3</p>  <p>42</p>
<p>CR125 11/16 x 2-7/8</p>  <p>66</p>	<p>CR136 13/16 x 4</p>  <p>56</p>	<p>CR148 13/16 x 3-1/16</p>  <p>55</p>
<p>CR126 13/16 x 3-1/4</p>  <p>40</p>	<p>CR138 1-7/8 x 1-15/16</p>  <p>39</p>	<p>CR149 5/8 x 3-1/4</p>  <p>66</p>
<p>CR127 3/4 x 3-1/4</p>  <p>36</p>	<p>CR139 3/4 x 3</p>  <p>73</p>	<p>CR150 3/4 x 3-1/2</p>  <p>41</p>

































<p>CR151 1-1/8 x 2-3/16</p>  <p>39</p>	<p>CR163 13/16 x 3-11/16</p>  <p>63</p>	<p>CR176 1-1/8 x 8-1/8</p>  <p>53</p>
<p>CR152 7/8 x 2-1/4</p>  <p>55</p>	<p>CR165 1-7/8 x 3-3/16</p>  <p>39</p>	<p>CR177 1-11/16 x 3-5/16</p>  <p>33</p>
<p>CR153 7/8 x 3-11/16</p>  <p>58</p>	<p>CR166 1-3/4 x 1-7/8</p>  <p>39</p>	<p>CR178 7/16 x 2-1/4</p>  <p>33</p>
<p>CR154 11/16 x 2</p>  <p>62</p>	<p>CR167 1 x 1-5/16</p>  <p>39</p>	<p>CR179 7/8 x 7-3/16</p>  <p>34</p>
<p>CR155 13/16 x 2-13/16</p>  <p>62</p>	<p>CR168 1-7/16 x 2-1/2</p>  <p>38</p>	<p>CR180 3/4 x 3-13/16</p>  <p>44</p>
<p>CR156 13/16 x 4</p>  <p>62</p>	<p>CR169 1/2 x 2-9/16</p>  <p>33</p>	<p>CR181 13/16 x 4-5/8</p>  <p>65</p>
<p>CR157 9/16 x 3-5/8</p>  <p>58</p>	<p>CR170 7/8 x 6-1/8</p>  <p>71</p>	<p>CR182 9/16 x 3-3/16</p>  <p>46</p>
<p>CR158 3/4 x 3-5/16</p>  <p>44</p>	<p>CR171 3/4 x 6-7/8</p>  <p>48</p>	<p>CR184 1 x 3-15/16</p>  <p>44</p>
<p>CR160 3/4 x 5-5/16</p>  <p>48</p>	<p>CR172 3/4 x 1-3/4</p>  <p>39</p>	<p>CR185 1/2 x 1-11/16</p>  <p>33</p>
<p>CR161 11/16 x 3-3/8</p>  <p>49</p>	<p>CR173 1-1/2 x 4-5/8</p>  <p>49</p>	<p>CR186 1-1/4 x 6-13/16</p>  <p>72</p>
<p>CR162 1-1/4 x 5-3/8</p>  <p>63</p>	<p>CR175 5/8 x 3-1/4</p>  <p>64</p>	<p>CR187 3/4 x 5-1/4</p>  <p>34</p>

<p>CR188 5/8 x 3-13/16</p>  <p>70</p>	<p>CR199 3 x 4</p>  <p>52</p>	<p>CR212 3/4 x 1-1/2</p>  <p>40</p>
<p>CR189 7/8 x 3-3/4</p>  <p>52</p>	<p>CR200 7/8 x 4-1/2</p>  <p>42</p>	<p>CR213 1-5/8 x 5-5/16</p>  <p>63</p>
<p>CR190 13/16 x 3-1/2</p>  <p>52</p>	<p>CR202 3/4 x 3/4</p>  <p>40</p>	<p>CR214 7/8 x 3-3/8</p>  <p>49</p>
<p>CR191 1-3/4 x 3</p>  <p>39</p>	<p>CR203 3/4 x 3</p>  <p>66</p>	<p>CR215 3/4 x 2-3/4</p>  <p>52</p>
<p>CR192 1-1/8 x 5-9/16</p>  <p>58</p>	<p>CR204 1/2 x 1-1/4</p>  <p>47</p>	<p>CR216 3/4 x 5-1/2</p>  <p>30</p>
<p>CR193 7/8 x 4-1/4</p>  <p>53</p>	<p>CR205 1-1/8 x 5-3/4</p>  <p>59</p>	<p>CR217 3/4 x 5-1/2</p>  <p>32</p>
<p>CR194 3/4 x 3-5/8</p>  <p>44</p>	<p>CR207 7/8 x 4-7/16</p>  <p>55</p>	<p>CR218 13/16 x 15/16</p>  <p>40</p>
<p>CR195 15/16 x 5-3/4</p>  <p>68</p>	<p>CR208 1-3/4 x 3-1/4</p>  <p>38</p>	<p>CR219 3/4 x 2-1/8</p>  <p>54</p>
<p>CR196 1-1/16 x 4-5/8</p>  <p>34</p>	<p>CR209 7/8 x 2-1/2</p>  <p>40</p>	<p>CR220 13/16 x 2-5/8</p>  <p>52</p>
<p>CR197 3/4 x 4-1/4</p>  <p>64</p>	<p>CR210 1-1/2 x 4-5/16</p>  <p>42</p>	<p>CR221 3/4 x 2-5/8</p>  <p>62</p>
<p>CR198 1-1/2 x 9-1/4</p>  <p>59</p>	<p>CR211 1-3/8 x 4-3/8</p>  <p>73</p>	<p>CR222 1-5/8 x 2-5/8</p>  <p>40</p>

<p>CR223 13/16 x 2-7/8</p>  <p>52</p>	<p>MS04 1-3/8 x 4-1/8</p>  <p>112</p>	<p>MS16 5/16 x 11/16</p>  <p>122</p>
<p>CR224 3/4 x 4-5/8</p>  <p>46</p>	<p>MS05 1-1/8 x 1-1/8</p>  <p>115</p>	<p>MS17 1-3/4 x 2-7/16</p>  <p>114</p>
<p>CR225 1-3/8 x 2-5/8</p>  <p>40</p>	<p>MS06 3/4 x 3/4</p>  <p>109</p>	<p>MS18 1-1/8 x 5</p>  <p>120</p>
<p>CR227 1-1/16 x 1-3/4</p>  <p>39</p>	<p>MS07 3/4 x 3/4</p>  <p>115</p>	<p>MS19 9/16 x 2-1/2</p>  <p>109</p>
<p>CR228 1-1/2 x 6-1/2</p>  <p>57</p>	<p>MS08 1-1/8 x 1-1/8</p>  <p>115</p>	<p>MS20 3/4 x 3-3/4</p>  <p>120</p>
<p>CR229 13/16 x 3-1/2</p>  <p>65</p>	<p>MS09 15/16 x 3-1/16</p>  <p>120</p>	<p>MS21 5/8 x 3-7/8</p>  <p>120</p>
<p>CR231 1-7/8 x 2-5/8</p>  <p>40</p>	<p>MS10 1-1/8 x 2-1/2</p>  <p>128</p>	<p>MS22 3/4 x 3-1/4</p>  <p>123</p>
<p>CR232 3/4 x 3-3/4</p>  <p>36</p>	<p>MS11 5/8 x 1-5/8</p>  <p>121</p>	<p>MS23 1-3/16 x 4-1/2</p>  <p>128</p>
<p>MS01 13/16 x 2-3/4</p>  <p>107</p>	<p>MS13 13/16 x 3-1/16</p>  <p>119</p>	<p>MS24 1-1/4 x 1-7/8</p>  <p>116</p>
<p>MS02 3/8 x 1</p>  <p>122</p>	<p>MS14 1/2 x 7/8</p>  <p>122</p>	<p>MS25 1 x 5-3/4</p>  <p>123</p>
<p>MS03 3/4 x 1-3/4</p>  <p>112</p>	<p>MS15 1 x 1-7/16</p>  <p>116</p>	<p>MS26 3/4 x 3-1/2</p>  <p>121</p>





<p>MS27 1-9/16 x 2-1/16</p>  <p>113</p>	<p>MS39 2-7/8 x 2-7/8</p>  <p>124</p>	<p>MS50 3/4 x 5-7/16</p>  <p>118</p>
<p>MS28 2-1/2 x 7</p>  <p>126</p>	<p>MS40 1-15/16 x 2-1/8</p>  <p>113</p>	<p>MS51 1-1/16 x 5-11/16</p>  <p>128</p>
<p>MS29 1-1/4 x 3-13/16</p>  <p>112</p>	<p>MS41 1-1/4 x 1-1/2</p>  <p>113</p>	<p>MS52 3/4 x 1-3/4</p>  <p>110</p>
<p>MS30 3/4 x 4-3/16</p>  <p>118</p>	<p>MS42 1-3/8 x 4-1/8</p>  <p>112</p>	<p>MS53 1/2 x 3/4</p>  <p>111</p>
<p>MS31 15/16 x 1</p>  <p>116</p>	<p>MS43 3/4 x 1-1/4</p>  <p>112</p>	<p>MS54 1/2 x 13/16</p>  <p>131</p>
<p>MS32 1-7/16 x 5-1/8</p>  <p>110</p>	<p>MS44 13/16 x 1-3/4</p>  <p>110</p>	<p>MS55 3/4 x 3/4</p>  <p>131</p>
<p>MS33 11/16 x 4-1/2 (or 7-1/4)</p>  <p>118</p>	<p>MS45 3/4 x 1-9/16</p>  <p>110</p>	<p>MS56 1/4 x 1</p>  <p>122</p>
<p>MS34 2-1/2 x 5-1/2</p>  <p>127</p>	<p>MS46 3/4 x 2-1/2</p>  <p>109</p>	<p>MS57 2 x 4</p>  <p>114</p>
<p>MS35 5/8 x 5-7/16</p>  <p>108</p>	<p>MS47 7/8 x 2-1/2</p>  <p>108</p>	<p>MS58 2-1/2 x 2-1/2</p>  <p>112</p>
<p>MS36 3/4 x 2-3/8</p>  <p>122</p>	<p>MS48 5/8 x 3-5/8</p>  <p>128</p>	<p>MS59 7/8 x 2-1/16</p>  <p>111</p>
<p>MS38 7/8 x 2-3/16</p>  <p>122</p>	<p>MS49 3/4 x 3-1/4</p>  <p>120</p>	<p>MS60 1-3/4 x 1-3/4</p>  <p>112</p>

<p>MS61 3/4 x 1-1/2</p>  <p>114</p>	<p>MS73 11/16 x 3-5/16</p>  <p>123</p>	<p>MS86 13/16 x 1-9/16</p>  <p>116</p>
<p>MS63 5/8 x 5/8</p>  <p>111</p>	<p>MS74 3/16 x 11/16</p>  <p>122</p>	<p>MS87 13/16 x 7/8</p>  <p>131</p>
<p>MS64 1/2 x 3/4</p>  <p>111</p>	<p>MS75 3/4 x 3/4</p>  <p>121</p>	<p>MS88 11/16 x 13/16</p>  <p>131</p>
<p>MS65 3/4 x 3/4</p>  <p>111</p>	<p>MS77 9/16 x 1-1/2</p>  <p>121</p>	<p>MS89 1-1/2 x 5</p>  <p>118</p>
<p>MS66 1/2 x 1/2</p>  <p>111</p>	<p>MS79 1-3/16 x 1-5/16</p>  <p>113</p>	<p>MS90 1-1/4 x 1-1/2</p>  <p>125</p>
<p>MS67 7/16 x 15/16</p>  <p>114</p>	<p>MS80 1-3/8 x 2-5/16</p>  <p>130</p>	<p>MS91 1-9/16 x 3-1/6</p>  <p>109</p>
<p>MS68 3/4 x 1-7/8</p>  <p>111</p>	<p>MS81 1-3/4 x 2-3/16</p>  <p>130</p>	<p>MS92 5/8 x 1-1/8</p>  <p>113</p>
<p>MS69 3/4 x 1-5/16</p>  <p>121</p>	<p>MS82 1/2 x 15/16</p>  <p>131</p>	<p>MS93 1 x 1-1/16</p>  <p>113</p>
<p>MS70 3/8 x 3/8</p>  <p>111</p>	<p>MS83 5/8 x 1-5/16</p>  <p>131</p>	<p>MS94 3/8 x 5/8</p>  <p>131</p>
<p>MS71 3/4 x 1-5/8</p>  <p>121</p>	<p>MS84 5/8 x 1-1/4</p>  <p>121</p>	<p>MS95 1-9/16 x 1-9/16</p>  <p>112</p>
<p>MS72 3/4 x 2-1/16</p>  <p>108</p>	<p>MS85 3/4 x 2-3/8</p>  <p>109</p>	<p>MS96 3/4 x 1-11/16</p>  <p>131</p>

<p>MS97 1-3/8 x 2-1/16</p>  <p>125</p>	<p>MS110 1-3/8 x 3-1/16</p>  <p>116</p>	<p>MS121 1-1/8 x 3</p>  <p>126</p>
<p>MS98 1 x 1</p>  <p>113</p>	<p>MS111 13/16 x 4-11/16</p>  <p>128</p>	<p>MS122 1 x 2-15/16</p>  <p>128</p>
<p>MS99 1-5/16 x 1-1/2</p>  <p>113</p>	<p>MS112 1-1/16 x 1-1/16</p>  <p>122</p>	<p>MS123 2-1/16 x 3</p>  <p>125</p>
<p>MS101 3/4 x 5-11/16</p>  <p>128</p>	<p>MS113 1-1/2 x 1-3/4</p>  <p>122</p>	<p>MS124 3/4 x 1-9/16</p>  <p>110</p>
<p>MS102 1-1/8 x 5-5/16</p>  <p>119</p>	<p>MS114 1-1/2 x 2</p>  <p>122</p>	<p>MS125 3/4 x 1-13/16</p>  <p>111</p>
<p>MS103 1-1/2 x 3</p>  <p>126</p>	<p>MS115 1-1/2 x 1-7/8</p>  <p>122</p>	<p>MS126 3/4 x 1-1/2</p>  <p>121</p>
<p>MS104 13/16 x 2-15/16</p>  <p>107</p>	<p>MS116 1-3/8 x 1-3/8</p>  <p>115</p>	<p>MS127 3/4 x 2-15/16</p>  <p>123</p>
<p>MS106 1-15/16 x 3-1/8</p>  <p>127</p>	<p>MS117 1-1/4 x 3-7/16</p>  <p>122</p>	<p>MS128 3/4 x 3/4</p>  <p>113</p>
<p>MS107 4-1/4"</p>  <p>127</p>	<p>MS118 3/4 x 1-1/2</p>  <p>108</p>	<p>MS129 3/4 x 1-1/8</p>  <p>108</p>
<p>MS108 1-1/4 x 7-3/8</p>  <p>129</p>	<p>MS119 1-3/4 x 3-1/16</p>  <p>125</p>	<p>MS130 3/8 x 1-1/16</p>  <p>123</p>
<p>MS109 1-1/4 x 3</p>  <p>116</p>	<p>MS120 1-1/4 x 4-1/16</p>  <p>108</p>	<p>MS131 1-9/16 x 2-3/4</p>  <p>123</p>









<p>MS132 7/8 x 2</p>  <p>113</p>	<p>MS143 1-3/16 x 2-1/2</p>  <p>123</p>	<p>MS155 1-1/4 x 2-7/8</p>  <p>116</p>
<p>MS133 1 x 1-1/4</p>  <p>109</p>	<p>MS144 3/4 x 1-3/4</p>  <p>121</p>	<p>MS156 1 x 1-11/16</p>  <p>124</p>
<p>MS134 1-1/16 x 1-1/16</p>  <p>111</p>	<p>MS145 3/4 x 2-1/2</p>  <p>121</p>	<p>MS157 3/4 x 2-3/16</p>  <p>121</p>
<p>MS135 1-1/4 x 1-3/8</p>  <p>109</p>	<p>MS146 2-5/8 x 2-5/8</p>  <p>115</p>	<p>MS158 3/4 x 2-3/16</p>  <p>121</p>
<p>MS136 1-1/4 x 2-1/4</p>  <p>115</p>	<p>MS148 3/4 x 2-5/8</p>  <p>117</p>	<p>MS159 3/4 x 3-1/2</p>  <p>107</p>
<p>MS137 7/8 x 7/8</p>  <p>111</p>	<p>MS149 1-1/8 x 2-13/16</p>  <p>119</p>	<p>MS160 1-1/2 x 3-1/8</p>  <p>129</p>
<p>MS138 7/8 x 3-7/8</p>  <p>119</p>	<p>MS150 1 x 3-1/4</p>  <p>119</p>	<p>MS161 9/16 x 1-1/8</p>  <p>131</p>
<p>MS139 1-7/16 x 1-5/8</p>  <p>127</p>	<p>MS151 3/4 x 3-1/8</p>  <p>121</p>	<p>MS162 2-1/2"</p>  <p>124</p>
<p>MS140 13/16 x 3</p>  <p>119</p>	<p>MS152 1-1/16 x 2-9/16</p>  <p>117</p>	<p>MS163 1 x 1-3/4</p>  <p>121</p>
<p>MS141 1-1/2 x 2-9/16</p>  <p>130</p>	<p>MS153 1-3/8 x 4-1/4</p>  <p>108</p>	<p>MS164 1-3/8 x 2-7/16</p>  <p>130</p>
<p>MS142 7/8 x 1-11/16</p>  <p>123</p>	<p>MS154 7/8 x 1-13/16</p>  <p>119</p>	<p>MS165 1-5/16 x 3-3/4</p>  <p>130</p>

<p>MS166 1 x 2</p>  <p>130</p>	<p>MS178 7/8 x 2-1/2</p>  <p>107</p>	<p>MS190 3/4 x 3</p>  <p>119</p>
<p>MS167 5/8 x 11/16</p>  <p>121</p>	<p>MS179</p>  <p>107</p>	<p>MS191 1-1/8 x 2-1/2</p>  <p>110</p>
<p>MS168 1 x 1-1/2</p>  <p>130</p>	<p>MS180 11/16 x 1-5/8</p>  <p>109</p>	<p>MS192 1-5/8 x 2</p>  <p>115</p>
<p>MS169 1 x 4-7/16</p>  <p>117</p>	<p>MS181 1-1/2 x 5-3/8</p>  <p>110</p>	<p>MS193 3/4 x 5-3/8</p>  <p>118</p>
<p>MS170 1-3/8 x 4-3/8</p>  <p>132</p>	<p>MS183 3/4 x 1-5/8</p>  <p>122</p>	<p>MS194 3/4 x 1-1/2</p>  <p>130</p>
<p>MS171 3/4 x 5-15/16</p>  <p>117</p>	<p>MS184 1-1/2 x 3-13/16</p>  <p>116</p>	<p>MS195 13/16 x 2-1/2</p>  <p>108</p>
<p>MS172 3/4 x 3-15/16</p>  <p>117</p>	<p>MS185 3/4 x 3</p>  <p>108</p>	<p>MS196 7/8 x 2-15/16</p>  <p>107</p>
<p>MS173 2 x 8</p>  <p>124</p>	<p>MS186 5/16 x 1-9/16</p>  <p>109</p>	<p>MS197 3/4 x 3</p>  <p>107</p>
<p>MS175 5/8 x 3-3/8</p>  <p>117</p>	<p>MS187 9/16 x 1-7/16</p>  <p>111</p>	<p>MS198 1/2 x 3/4</p>  <p>131</p>
<p>MS176 3/4 x 2-3/16</p>  <p>117</p>	<p>MS188 1-1/4 x 2-1/4</p>  <p>126</p>	<p>MS199 7/8 x 1-3/16</p>  <p>115</p>
<p>MS177</p>  <p>110</p>	<p>MS189 3/4 x 2</p>  <p>123</p>	<p>MS201 3/4 x 4-3/8</p>  <p>129</p>



<p>MS202 2-1/4 x 2-3/8</p>  <p>109</p>	<p>MS213 3/4 x 2-1/2</p>   <p>107</p>	<p>MS227 2-9/16 x 2-5/8</p>  <p>129</p>
<p>MS203 9/16 x 1-3/8</p>  <p>113</p>	<p>MS214 1 x 1-1/2</p>  <p>116</p>	<p>MS228 13/16 x 2-1/8</p>  <p>107</p>
<p>MS204 3/4 x 2</p>  <p>131</p>	<p>MS216 3-3/8 x 4-5/16</p>  <p>131</p>	<p>MS229 13/16 x 2-1/4</p>  <p>107</p>
<p>MS205 1/2 x 1-3/16</p>  <p>121</p>	<p>MS217 1 x 1-1/2</p>  <p>131</p>	<p>MS230 7/8 x 2-7/8</p>  <p>107</p>
<p>MS206 1-3/8 x 3-1/2</p>  <p>126</p>	<p>MS218 5/8 x 1-3/4</p>  <p>120</p>	<p>PO01 1/2 x 3/4</p>  <p>135</p>
<p>MS207 1-9/16 x 1-15/16</p>  <p>126</p>	<p>MS219 1-5/8 x 3-5/8</p>  <p>111</p>	<p>PO02 5/16 x 1-1/16</p>  <p>145</p>
<p>MS208 1-5/16 x 3-1/4</p>  <p>126</p>	<p>MS220 3/4 x 3-1/4</p>  <p>120</p>	<p>PO03 3/8 x 3/4</p>  <p>145</p>
<p>MS209 3/4 x 3-1/8</p>  <p>123</p>	<p>MS221 1/2 x 1</p>  <p>119</p>	<p>PO04 11/16 x 1-3/4</p>  <p>145</p>
<p>MS210 1-5/8 x 5-1/2</p>  <p>125</p>	<p>MS222 5/8 x 1-3/8</p>  <p>131</p>	<p>PO05 1/4 x 3/4</p>  <p>135</p>
<p>MS211 3/4 x 2</p>  <p>130</p>	<p>MS225 13/16 x 3-1/4</p>  <p>120</p>	<p>PO06 1/8 x 1-1/4</p>  <p>145</p>
<p>MS212 3/4 x 2-1/2</p>   <p>107</p>	<p>MS226 1 x 3</p>  <p>125</p>	<p>PO07 7/16 x 3/4</p>  <p>145</p>

<p>PO08 3/8 x 11/16</p>  <p>140</p>	<p>PO19 11/16 x 1-3/8</p>  <p>135</p>	<p>PO30 1 x 3-1/16</p>  <p>137</p>
<p>PO09 9/16 x 11/16</p>  <p>135</p>	<p>PO20 7/8 x 1-3/8</p>  <p>136</p>	<p>PO31 1/2 x 3/4</p>  <p>135</p>
<p>PO10 1-1/4 x 1-3/4</p>  <p>139</p>	<p>PO21 15/16 x 2</p>  <p>142</p>	<p>PO32 9/16 x 1-5/8</p>  <p>143</p>
<p>PO11 1-11/16 x 5-1/16</p>  <p>138</p>	<p>PO22 13/16 x 2-1/4</p>  <p>135</p>	<p>PO33 1-3/8 x 3-15/16</p>  <p>141</p>
<p>PO12 11/16 x 1-1/2</p>  <p>145</p>	<p>PO23 3/4 x 2-15/16</p>  <p>136</p>	<p>PO34 3/4 x 1-7/8</p>  <p>143</p>
<p>PO13 1/2 x 1-1/2</p>  <p>145</p>	<p>PO24 1/2 x 1-1/2</p>  <p>143</p>	<p>PO35 1/2 x 13/16</p>  <p>135</p>
<p>PO14 3/4 x 1-1/2</p>  <p>145</p>	<p>PO25 11/16 x 1-1/8</p>  <p>135</p>	<p>PO36 1-1/16 x 1-5/8</p>  <p>139</p>
<p>PO15 1-1/16 x 1-7/16</p>  <p>139</p>	<p>PO26 3/4 x 7/8</p>  <p>135</p>	<p>PO37 11/16 x 1-3/4</p>  <p>135</p>
<p>PO16 7/8 x 1-7/8</p>  <p>143</p>	<p>PO27 11/16 x 1-5/8</p>  <p>135</p>	<p>PO38 13/16 x 3</p>  <p>137</p>
<p>PO17 11/16 x 2-1/2</p>  <p>136</p>	<p>PO28 3/4 x 7/8</p>  <p>140</p>	<p>PO39 1/2 x 1-1/16</p>  <p>145</p>
<p>PO18 3/4 x 1-3/4</p>  <p>136</p>	<p>PO29 1 x 1</p>  <p>144</p>	<p>PO40 3/4 x 1-5/16</p>  <p>135</p>

<p>PO41 1-1/4 x 2</p>  <p>142</p>	<p>PO52 1-1/16 x 2-9/16</p>  <p>138</p>	<p>PO63 7/16 x 13/16</p>  <p>140</p>
<p>PO42 3/4 x 1-11/16</p>  <p>138</p>	<p>PO53 11/16 x 1-13/16</p>  <p>140</p>	<p>PO64 1/2 x 13/16</p>  <p>140</p>
<p>PO43 7/8 x 1-7/16</p>  <p>137</p>	<p>PO54 1-1/4 x 2-5/16</p>  <p>140</p>	<p>PO65 3/4 x 1-3/4</p>  <p>137</p>
<p>PO44 1 x 2-1/16</p>  <p>145</p>	<p>PO55 11/16 x 1-13/16</p>  <p>138</p>	<p>PO66 3/4 x 1-7/8</p>  <p>145</p>
<p>PO45 5/8 x 1-3/8</p>  <p>137</p>	<p>PO56 1-1/8 x 1-7/8</p>  <p>140</p>	<p>PO67 1/2 x 13/16</p>  <p>135</p>
<p>PO46 1-1/16 x 1-5/8</p>  <p>137</p>	<p>PO57 1-3/8 x 2-11/16</p>  <p>138</p>	<p>PO68 5/8 x 1-5/8</p>  <p>138</p>
<p>PO47 3/4 x 1-11/16</p>  <p>141</p>	<p>PO58 3/4 x 2</p>  <p>140</p>	<p>PO69 15/16 x 1-1/2</p>  <p>138</p>
<p>PO48 13/16 x 2-1/8</p>  <p>136</p>	<p>PO59 1-13/16 x 3-1/8</p>  <p>138</p>	<p>PO70 3/8 x 3/4</p>  <p>145</p>
<p>PO49 7/16 x 1-7/16</p>  <p>142</p>	<p>PO60 3/4 x 1-5/8</p>  <p>140</p>	<p>PO71 13/16 x 1-3/8</p>  <p>140</p>
<p>PO50 1-3/8 x 2-1/2</p>  <p>142</p>	<p>PO61 7/16 x 7/8</p>  <p>135</p>	<p>PO72 13/16 x 2-1/4</p>  <p>142</p>
<p>PO51 1/2 x 1-1/4</p>  <p>145</p>	<p>PO62 9/16 x 1-3/16</p>  <p>137</p>	<p>PO73 9/16 x 1-7/16</p>  <p>143</p>

<p>PO75 1-3/4 x 3-7/8</p>  <p>141</p>	<p>PO86 1-9/16 x 5-3/16</p>  <p>141</p>	<p>PO97 3/4 x 2-7/16</p>  <p>143</p>
<p>PO76 7/8 x 2-1/4</p>  <p>135</p>	<p>PO87 1-3/8 x 3-1/2</p>  <p>141</p>	<p>PO98 9/16 x 15/16</p>  <p>145</p>
<p>PO77 11/16 x 2</p>  <p>136</p>	<p>PO88 9/16 x 1-5/16</p>  <p>135</p>	<p>PO99 13/16 x 1-1/2</p>  <p>136</p>
<p>PO78 1-1/8 x 4-1/4</p>  <p>136</p>	<p>PO89 3/4 x 2</p>  <p>143</p>	<p>PO100 3/8 x 3/4</p>  <p>143</p>
<p>PO79 3/4 x 1-3/4</p>  <p>143</p>	<p>PO90 15/16 x 1-5/16</p>  <p>140</p>	<p>PO101 15/16 x 1-5/16</p>  <p>137</p>
<p>PO80 1/2 x 1-5/16</p>  <p>135</p>	<p>PO91 1-7/16 x 2-3/8</p>  <p>139</p>	<p>PO102 5/8 x 2</p>  <p>137</p>
<p>PO81 3/4 x 2-1/2</p>  <p>143</p>	<p>PO92 3/4 x 1-9/16</p>  <p>143</p>	<p>PO103 7/16 x 1-1/16</p>  <p>137</p>
<p>PO82 3/4 x 3-1/2</p>  <p>143</p>	<p>PO93 3/4 x 1-15/16</p>  <p>137</p>	<p>PO104 9/16 x 1-1/2</p>  <p>135</p>
<p>PO83 1 x 2-5/16</p>  <p>145</p>	<p>PO94 1/2 x 1-3/8</p>  <p>135</p>	<p>PO105 5/8 x 1-7/16</p>  <p>143</p>
<p>PO84 1/2 x 15/16</p>  <p>137</p>	<p>PO95 7/16 x 1-1/8</p>  <p>145</p>	<p>PO106 3/4 x 1-3/4</p>  <p>135</p>
<p>PO85 7/8 x 1-3/4</p>  <p>136</p>	<p>PO96 3/8 x 3/4</p>  <p>145</p>	<p>PO107 3/4 x 1-3/4</p>  <p>145</p>



<p>PO108 7/8 x 1-7/8</p>  <p>137</p>	<p>PO119 1 x 1-1/2</p>  <p>139</p>	<p>PO130 9/16 x 7/8</p>  <p>144</p>
<p>PO109 1-1/2 x 2-9/16</p>  <p>139</p>	<p>PO120 3/4 x 1-7/16</p>  <p>145</p>	<p>PO131 1/2 x 1-3/4</p>  <p>135</p>
<p>PO110 13/16 x 1-9/16</p>  <p>139</p>	<p>PO121 7/8 x 1-5/16</p>  <p>139</p>	<p>PO132 1-3/16 x 2-7/16</p>  <p>143</p>
<p>PO111 2 x 4</p>  <p>142</p>	<p>PO122 1-7/16 x 2-7/16</p>  <p>141</p>	<p>PO133 13/16 x 1-1/2</p>  <p>140</p>
<p>PO112 5/8 x 1-1/4</p>  <p>135</p>	<p>PO123 1 x 1-13/16</p>  <p>141</p>	<p>PO134 5/16 x 3/4</p>  <p>137</p>
<p>PO113 1 x 2-1/16</p>  <p>136</p>	<p>PO124 2-11/16 x 2-3/4</p>  <p>142</p>	<p>PO135 9/16 x 7/8</p>  <p>135</p>
<p>PO114 5/8 x 1-11/16</p>  <p>140</p>	<p>PO125 1-1/4 x 1-1/2</p>  <p>142</p>	<p>PO136 3/4 x 1-5/16</p>  <p>140</p>
<p>PO115 9/16 x 1-1/8</p>  <p>140</p>	<p>PO126 5/8 x 7/8</p>  <p>143</p>	<p>PO137 5/8 x 1-7/8</p>  <p>135</p>
<p>PO116 7/8 x 1-1/8</p>  <p>139</p>	<p>PO127 13/16 x 1-1/8</p>  <p>136</p>	<p>PO138 13/16 x 1-1/8</p>  <p>140</p>
<p>PO117 1-1/8 x 2-1/16</p>  <p>140</p>	<p>PO128 13/16 x 1-11/16</p>  <p>136</p>	<p>PO139 13/16 x 1-1/2</p>  <p>136</p>
<p>PO118 1-1/2 x 2-1/2</p>  <p>139</p>	<p>PO129 1-1/4 x 1-1/2</p>  <p>139</p>	<p>PO140 2-1/4 x 2-3/8</p>  <p>140</p>

































<p>PO141 11/16 x 1-5/8</p>  <p>137</p>	<p>PO152 9/16 x 1-1/16</p>  <p>138</p>	<p>RA02 1-11/16 x 1-15/16</p>  <p>151</p>
<p>PO142 1-1/16 x 2-1/16</p>  <p>139</p>	<p>PO153 15/16 x 1-1/8</p>  <p>144</p>	<p>RA03 3/4 x 2-1/4</p>  <p>152</p>
<p>PO143 3/8 x 1-13/16</p>  <p>144</p>	<p>PO154 7/8 x 1-3/16</p>  <p>144</p>	<p>RA04 1-1/2 x 1-3/4</p>  <p>151</p>
<p>PO144 13/16 x 1-5/8</p>  <p>144</p>	<p>PO155 5/8 x 15/16</p>  <p>144</p>	<p>RA05 7/8 x 1-3/8</p>  <p>150</p>
<p>PO145 1-1/8 x 2-1/8</p>  <p>144</p>	<p>PO156 1/2 x 1-1/2</p>  <p>144</p>	<p>RA06 3/4 x 2-7/16</p>  <p>152</p>
<p>PO146 1-1/8 x 2-5/16</p>  <p>144</p>	<p>PO157 5/8 x 13/16</p>  <p>144</p>	<p>RA07 1-3/16 x 3-7/16</p>  <p>149</p>
<p>PO147 5/8 x 1-3/16</p>  <p>144</p>	<p>PO158 5/8 x 1-7/16</p>  <p>145</p>	<p>RA08 1-7/16 x 2-13/16</p>  <p>154</p>
<p>PO148 11/16 x 2-1/4</p>  <p>144</p>	<p>PO159 3/4 x 7/8</p>  <p>141</p>	<p>RA09 1-1/16 x 1-1/16</p>  <p>148</p>
<p>PO149 3/4 x 1-5/16</p>  <p>135</p>	<p>PO160 1 x 1-1/2</p>  <p>139</p>	<p>RA10 13/16 x 1-5/16</p>  <p>154</p>
<p>PO150 1-1/4 x 2</p>  <p>144</p>	<p>PO161 1/2 x 7/8</p>  <p>144</p>	<p>RA11 1-1/8 x 1-3/4</p>  <p>153</p>
<p>PO151 3/4 x 1-1/8</p>  <p>144</p>	<p>RA01 7/8 x 1</p>  <p>148</p>	<p>RA12 7/8 x 1</p>  <p>149</p>













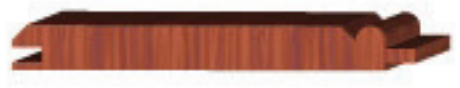







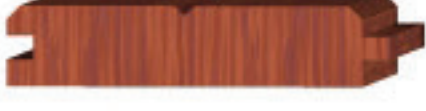











<p>RA13 13/16 x 1-3/4</p>  <p>152</p>	<p>RA24 3/4 x 1-3/8</p>  <p>150</p>	<p>RA35 3/4 x 1-1/4</p>  <p>153</p>
<p>RA14 5/8 x 1-3/16</p>  <p>150</p>	<p>RA25 1 x 2-1/8</p>  <p>148</p>	<p>RA36 7/8 x 2</p>  <p>153</p>
<p>RA15 3/4 x 1-3/8</p>  <p>150</p>	<p>RA26 9/16 x 1-1/8</p>  <p>153</p>	<p>RA38 7/8 x 1-13/16</p>  <p>150</p>
<p>RA16 3/4 x 2-1/8</p>  <p>148</p>	<p>RA27 13/16 x 1-1/2</p>  <p>148</p>	<p>RA39 1 x 1-5/8</p>  <p>152</p>
<p>RA17 7/8 x 1-15/16</p>  <p>152</p>	<p>RA28 3/4 x 1-1/2</p>  <p>148</p>	<p>RA40 7/8 x 2-1/2</p>  <p>152</p>
<p>RA18 5/8 x 1</p>  <p>151</p>	<p>RA29 13/16 x 2-7/16</p>  <p>152</p>	<p>RA41 13/16 x 1-13/16</p>  <p>152</p>
<p>RA19 1-1/8 x 1-1/8</p>  <p>148</p>	<p>RA30 1-9/16 x 1-3/4</p>  <p>148</p>	<p>RA42 11/16 x 2-5/8</p>  <p>154</p>
<p>RA20 3/4 x 1-5/16</p>  <p>151</p>	<p>RA31 3/4 x 1-1/4</p>  <p>149</p>	<p>RA43 3/4 x 2-13/16</p>  <p>154</p>
<p>RA21 5/8 x 15/16</p>  <p>149</p>	<p>RA32 3/4 x 1-7/16</p>  <p>153</p>	<p>RA44 7/8 x 2</p>  <p>152</p>
<p>RA22 1-1/8 x 1-5/16</p>  <p>151</p>	<p>RA33 11/16 x 1-1/16</p>  <p>151</p>	<p>RA45 7/8 x 2</p>  <p>152</p>
<p>RA23 3/4 x 2</p>  <p>153</p>	<p>RA34 1-7/8 x 2-9/16</p>  <p>154</p>	<p>RA46 1-1/8 x 1-3/8</p>  <p>154</p>







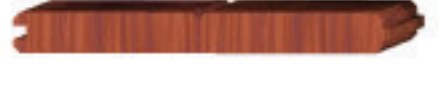











<p>RA48 5/8 x 13/16</p>  <p>150</p>	<p>RA59 1 x 2</p>  <p>148</p>	<p>RA71 11/16 x 2-7/8</p>  <p>152</p>
<p>RA49 15/16 x 1-3/4</p>  <p>149</p>	<p>RA60 1-1/8 x 2-1/16</p>  <p>150</p>	<p>RA72 5/8 x 1-1/16</p>  <p>149</p>
<p>RA50 3/4 x 1-3/4</p>  <p>154</p>	<p>RA61 1-3/16 x 2-5/8</p>  <p>148</p>	<p>RA73 7/8 x 1-1/8</p>  <p>150</p>
<p>RA51 3/4 x 2-5/16</p>  <p>153</p>	<p>RA62 1-3/4 x 2-7/8</p>  <p>151</p>	<p>RA74 1-1/16 x 1-1/16</p>  <p>149</p>
<p>RA52 1-1/4 x 2-1/4</p>  <p>153</p>	<p>RA63 1-1/2 x 3-3/8</p>  <p>154</p>	<p>RA75 15/16 x 1-15/16</p>  <p>149</p>
<p>RA53 7/8 x 2-1/4</p>  <p>150</p>	<p>RA64 1-1/8 x 1-5/16</p>  <p>153</p>	<p>RA76 1-1/4 x 1-1/2</p>  <p>151</p>
<p>RA54 1/2 x 2</p>  <p>153</p>	<p>RA66 7/8 x 1-3/8</p>  <p>150</p>	<p>RA77 1-1/2 x 3-3/8</p>  <p>154</p>
<p>RA55 1 x 1-1/4</p>  <p>150</p>	<p>RA67 1-3/16 x 2-5/16</p>  <p>148</p>	<p>RA78 1/2 x 1-3/4</p>  <p>154</p>
<p>RA56 3/4 x 2-5/16</p>  <p>153</p>	<p>RA68 7/8 x 1-3/4</p>  <p>151</p>	<p>RA79 1-1/8 x 2</p>  <p>153</p>
<p>RA57 1-1/8 x 2-5/16</p>  <p>153</p>	<p>RA69 13/16 x 1-1/4</p>  <p>151</p>	<p>RA80 13/16 x 1-3/4</p>  <p>149</p>
<p>RA58 1-3/16 x 1-7/16</p>  <p>149</p>	<p>RA70 9/16 x 1-1/8</p>  <p>150</p>	<p>RA81 15/16 x 3-3/16</p>  <p>150</p>

<p>RA82 3/4 x 1/8</p>  <p>150</p>	<p>RA93 5/8 x 2-3/16</p>  <p>152</p>	<p>RA106 1-3/16 x 2-1/2</p>  <p>149</p>
<p>RA83 7/8 x 1-13/16</p>  <p>150</p>	<p>RA95 3/4 x 1</p>  <p>150</p>	<p>RA107 1-3/8 x 2-1/4</p>  <p>151</p>
<p>RA84 11/16 x 1-1/8</p>  <p>150</p>	<p>RA96 3/4 x 1-1/16</p>  <p>149</p>	<p>RA108 1/2 x 3/4</p>  <p>154</p>
<p>RA85 11/16 x 1-3/4</p>  <p>152</p>	<p>RA97 1-1/8 x 1-3/4</p>  <p>150</p>	<p>RA109 1-5/16 x 2-1/16</p>  <p>148</p>
<p>RA86 5/8 x 1-3/16</p>  <p>150</p>	<p>RA98 1-3/8 x 2-3/4</p>  <p>152</p>	<p>RA110 1-3/8 x 1-11/16</p>  <p>148</p>
<p>RA87 13/16 x 2</p>  <p>149</p>	<p>RA99 3/4 x 1-1/4</p>  <p>149</p>	<p>RA111 1 x 1-3/4</p>  <p>152</p>
<p>RA88 1-1/16 x 1-1/2</p>  <p>150</p>	<p>RA100 11/16 x 1-9/16</p>  <p>153</p>	<p>RA112 15/16 x 1-15/16</p>  <p>149</p>
<p>RA89 1-1/16 x 1-11/16</p>  <p>149</p>	<p>RA101 1-7/8 x 4</p>  <p>154</p>	<p>RA113 1-3/16 x 1-7/8</p>  <p>148</p>
<p>RA90 1 x 1</p>  <p>151</p>	<p>RA102 13/16 x 1-1/16</p>  <p>151</p>	<p>RA114 1-1/8 x 1-7/16</p>  <p>151</p>
<p>RA91 1-1/8 x 1-5/8</p>  <p>149</p>	<p>RA104 5/8 x 1-3/16</p>  <p>149</p>	<p>RA115 1-3/8 x 1-1/2</p>  <p>150</p>
<p>RA92 13/16 x 1-1/8</p>  <p>150</p>	<p>RA105 7/8 x 1-5/8</p>  <p>153</p>	<p>RA116 5/8 x 2-1/16</p>  <p>153</p>

<p>RA117 3/4 x 1-1/4</p>  <p>153</p>	<p>SS07 7/16 x 1-1/4</p>  <p>156</p>	<p>SS18 3/8 x 5/8</p>  <p>156</p>
<p>RA118 5/8 x 7/8</p>  <p>149</p>	<p>SS08 1/2 x 1-1/2</p>  <p>156</p>	<p>SS19 5/8 x 3/4</p>  <p>156</p>
<p>RA119 7/16 x 1-5/8</p>  <p>148</p>	<p>SS09 3/8 x 1-11/16</p>  <p>156</p>	<p>SS20 9/16 x 13/16</p>  <p>156</p>
<p>RA120 1-1/4 x 1-3/4</p>  <p>148</p>	<p>SS10 1/2 x 1-3/4</p>  <p>156</p>	<p>SS21 9/16 x 11/16</p>  <p>156</p>
<p>RA121 11/16 x 1-11/16</p>  <p>150</p>	<p>SS11 5/16 x 1-5/16</p>  <p>156</p>	<p>SS22 7/16 x 9/16</p>  <p>156</p>
<p>SS01 5/16 x 1-1/16</p>  <p>156</p>	<p>SS12 1/2 x 1-3/8</p>  <p>156</p>	<p>SS23 9/16 x 1-7/16</p>  <p>156</p>
<p>SS02 3/8 x 1-7/8</p>  <p>156</p>	<p>SS13 1/2 x 1-1/2</p>  <p>156</p>	<p>SS24 9/16 x 1-7/16</p>  <p>156</p>
<p>SS03 3/8 x 1-3/8</p>  <p>156</p>	<p>SS14 13/16 x 1-3/4</p>  <p>156</p>	<p>SS25 9/16 x 5/8</p>  <p>156</p>
<p>SS04 1/2 x 1-5/16</p>  <p>156</p>	<p>SS15 7/16 x 1-1/8</p>  <p>156</p>	<p>SS26 9/16 x 13/16</p>  <p>156</p>
<p>SS05 3/8 x 1-11/16</p>  <p>156</p>	<p>SS16 1/2 x 1-13/16</p>  <p>156</p>	<p>SS27 9/16 x 7/8</p>  <p>156</p>
<p>SS06 1/2 x 1</p>  <p>156</p>	<p>SS17 13/16 x 1</p>  <p>156</p>	<p>SS28 1/2 x 9/16</p>  <p>156</p>

<p>SS29 7/16 x 5/8</p>  <p>156</p>	<p>ST11 1-1/2 x 1-3/8</p>  <p>159</p>	<p>ST6043 3 x 3-1/2</p>  <p>160</p>
<p>SS30 1/2 x 1-7/16</p>  <p>156</p>	<p>ST14 1-1/8 x 3-1/4</p>  <p>161</p>	<p>ST6044 2-1/2 x 4</p>  <p>162</p>
<p>SS31 9/16 x 1</p>  <p>156</p>	<p>ST15 1 x 2-1/4</p>  <p>161</p>	<p>ST6045 3/4 x 2-1/2</p>  <p>163</p>
<p>SS32 7/16 x 7/16</p>  <p>156</p>	<p>ST16 1-5/16 x 2-1/4</p>  <p>159</p>	<p>ST6046 1 x 3-1/16</p>  <p>163</p>
<p>SS33 1/2 x 3/4</p>  <p>156</p>	<p>ST17 1/4 x 1-1/4</p>  <p>163</p>	<p>ST6050</p>  <p>163</p>
<p>ST01 1-3/4 x 2-1/2</p>  <p>161</p>	<p>ST18 2-3/8 x 2-3/4</p>  <p>162</p>	<p>ST6052</p>  <p>163</p>
<p>ST02 2-1/2 x 3-11/16</p>  <p>161</p>	<p>ST6010 2-5/16 x 2-3/8</p>  <p>159</p>	<p>ST8000 2-1/4 x 2-5/8</p>  <p>159</p>
<p>ST03 1-1/2 x 1-1/2</p>  <p>161</p>	<p>ST6039 1-3/4 x 1-3/4</p>  <p>159</p>	<p>ST8001 2-3/16 x 3-1/8</p>  <p>160</p>
<p>ST04 1-11/16 x 5-9/16</p>  <p>158</p>	<p>ST6040 1-3/4 x 1-5/8</p>  <p>159</p>	<p>ST8002 1-11/16 x 5-11/16</p>  <p>160</p>
<p>ST05 1-3/4 x 4-1/16</p>  <p>158</p>	<p>ST6041 1-1/4 x 2-9/16</p>  <p>163</p>	<p>ST8006 1-1/2 x 5-7/16</p>  <p>162</p>
<p>ST06 1-5/16 x 5-1/2</p>  <p>158</p>	<p>ST6042 1-1/4 x 2-1/4</p>  <p>159</p>	<p>ST8007 3-5/16 x 5-1/8</p>  <p>163</p>

<p>WS01 7/16 x 5/8</p>  <p>171</p>	<p>WS12 1 x 2</p>  <p>169</p>	<p>WS24 11/16 x 2-7/8</p>  <p>168</p>
<p>WS02 2-1/4 x 2-5/8</p>  <p>172</p>	<p>WS13 1-1/8 x 2-1/16</p>  <p>168</p>	<p>WS25 5/8 x 1-1/16</p>  <p>170</p>
<p>WS03 2-3/16 x 3-1/8</p>  <p>168</p>	<p>WS14 1-3/16 x 2-5/8</p>  <p>169</p>	<p>WS27 3/8 x 2-7/8</p>  <p>168</p>
<p>WS04 1-11/16 x 5-11/16</p>  <p>169</p>	<p>WS15 1-3/4 x 2-7/8</p>  <p>169</p>	<p>WS28 7/8 x 1-1/8</p>  <p>172</p>
<p>WS05 1-1/2 x 5-7/16</p>  <p>169</p>	<p>WS16 1-1/2 x 3-3/8</p>  <p>173</p>	<p>WS30 1-1/16 x 1-1/16</p>  <p>173</p>
<p>WS06 3-5/16 x 5-1/8</p>  <p>171</p>	<p>WS17 1-1/8 x 1-5/16</p>  <p>168</p>	<p>WS31 15/16 x 1-15/16</p>  <p>169</p>
<p>WS07 1/2 x 2</p>  <p>171</p>	<p>WS18 7/8 x 1-3/8</p>  <p>168</p>	<p>WS32 1-1/4 x 1-1/2</p>  <p>169</p>
<p>WS08 1 x 1-1/4</p>  <p>171</p>	<p>WS19 1-3/16 x 2-5/16</p>  <p>168</p>	<p>WS33 1-1/2 x 3-3/8</p>  <p>170</p>
<p>WS09 3/4 x 2-5/16</p>  <p>172</p>	<p>WS20 7/8 x 1-3/4</p>  <p>169</p>	<p>WS34 1/2 x 1-3/4</p>  <p>168</p>
<p>WS10 1-1/8 x 2-5/16</p>  <p>172</p>	<p>WS21 13/16 x 1-1/4</p>  <p>168</p>	<p>WS35 1-1/8 x 2</p>  <p>171</p>
<p>WS11 1-3/16 x 1-7/16</p>  <p>173</p>	<p>WS22 9/16 x 1-1/8</p>  <p>168</p>	<p>WS36 13/16 x 1-3/4</p>  <p>170</p>

<p>WS37 7/8 x 5-1/4</p>  <p>170</p>	<p>WS48 13/16 x 7-1/2</p>  <p>172</p>
<p>WS38 1-1/2 x 7-1/2</p>  <p>173</p>	<p>WS76 1 x 2</p>  <p>148</p>
<p>WS39 1/2 x 2-5/8</p>  <p>170</p>	<p>BR01 1-3/4 x 5-1/2</p>  <p>165</p>
<p>WS40 3/4 x 6-1/4</p>  <p>172</p>	<p>BR02 1-3/4 x 5</p>  <p>165</p>
<p>WS41 3/4 x 5-1/2</p>  <p>170</p>	<p>BR03 1-1/8 x 5-1/4</p>  <p>165</p>
<p>WS42 3/4 x 5-15/16</p>  <p>173</p>	<p>BR04 1-3/8 x 5</p>  <p>166</p>
<p>WS43 5/8 x 6</p>  <p>169</p>	<p>BR06 1-3/8 x 4</p>  <p>166</p>
<p>WS44 11/16 x 9-1/8</p>  <p>174</p>	
<p>WS45 5/16 x 3-5/16</p>  <p>168</p>	
<p>WS46 3/8 x 3-1/8</p>  <p>168</p>	
<p>WS47 3/4 x 4-7/8</p>  <p>171</p>	

INTRODUCTION

Westgate Hardwoods is pleased to offer you the same quality products that have pleased our many satisfied customers since 1988. Please feel free to contact us about our many complimenting services or just drop by our showroom in Durham to see many of these catalog items on display.

PROFILES AND MATERIALS

Actual moulding profiles may vary slightly from the following catalog illustrations and Westgate Hardwoods reserves the right to delete or modify any catalog item. Hardwoods are a product of nature and a variety of color, grain, and texture are part of this natural charm. These are not imperfections but are simply part of the random beauty of wood and should be expected. You should also expect that normal surface preparation for wood will be required prior to finish.

PRICING

Please contact us for current pricing and availability. We are pleased to offer volume discounts with special consideration to industry related businesses.

TERMS

Open account terms are extended when Westgate Hardwoods has verified a satisfactory credit history. All major credit cards are accepted. Personal and company checks are accepted upon bank verification. A 50% deposit is required on all custom runs and special orders.

CUSTOM KNIFE GRINDING

If you can't find a moulding profile in this catalog contact us for a complete listing of the more than 1500 patterns we have available. You can also send us your scale drawing or sample. We can duplicate any profile to your exact specifications up to 4 in. high x 11 1/2" wide. Approximate cost for grinding is \$50.00 and up per inch rounded up to the nearest inch. Custom tooling is produced in house and remains the property of Westgate Hardwoods Inc.

SET UP CHARGES

Westgate Hardwoods Inc. reserves the right to fix or change set up charges at their discretion. Larger patterns, for example bar rail, will have a larger set up charge. General set up charge information for non stock species or special patterns in Westgate Hardwoods catalog are:

- Up to 299 lf \$75.00
- 300 lf and over no setup
- Large profile setup is \$175.00

RANDOM LENGTHS

Unless otherwise specified, orders will be quoted and manufactured in random lengths. Lengths generally run from 3' – 12'. Some species are available up to 16' and, if available, usually comprise a maximum of 15% of the order. 15% 3' – 6' are included in random length tally. We will try to accommodate your length requirements to the best of our ability and the wood that we have available.

SPECIFIED LENGTHS

Specified lengths are available within reason and stock permitting. We try to reserve our long lengths for Base and Crown mouldings. Casing can be specified to the number of legs (sidepieces) and heads (top pieces) needed, by ordering the exact length to the nearest foot. All reasonable efforts will be made to keep over- age to a minimum on specified length orders. All specified lengths with no overage will have 15% to 20% added to the price of the order. Instead of combining your shorter lengths and specifying long lengths, it is to your advantage and more economical to specify the actual lengths you need.

SPECIAL ORDERS

Flexible resin moulding, radius corners, custom wood radius work, and all other non-stock items are considered Special Orders and are not subject to returns, refunds, or exchanges. A deposit, or advance payment, is usually required on Special Order items. Special Orders are not subject to cancellation after production has begun.

RETURNS

All returns must be made within 30 days of purchase and accompanied with the original receipt. Stock items in good saleable condition will be charged 15% for restocking. No product that has been cut, damaged, stained, painted, marked with pen or pencil, shows signs of sun or water damage, or is marked with sheetrock compound or dirt, or mouldings less than 8' long will be accepted. Custom runs or special orders cannot be returned

LEAD TIME

Lead times vary between 5 – 10 working days, depending on the order size and production schedule. Longer lead times allow us greater flexibility, and may save you money. Westgate Hardwoods strives to meet your order requirements and rush orders can be delivered with an up-charge, schedule permitting.

LIMITATIONS

Additional Terms and Condition of Sale may be imposed on Buyer and are not included herein. Prior to purchase, it is your responsibility to make yourself aware of all Terms

and Conditions of Sale. Seller is not liable for indirect, special or consequential damages under any circumstances, including, but not limited to, damages or loss resulting from inability to use materials, increased operation costs or loss of production, attorney's fees, or any other damages. In all cases, Seller's maximum liability, whether resulting from breach of contract, negligence, or otherwise, shall not exceed the contract price of the materials supplied to Buyer.

GUARANTEE

Our goal is to achieve 100% customer satisfaction. At Westgate Hardwoods we stand behind our products and we pledge to resolve difficulties in a timely and courteous manner. Please inspect your order within 48 hours of receipt and report any problems immediately.

