



TUSCO DISPLAY
MICROMARKET PROGRAM

FEATURES & BENEFITS

FLEXIBLE PROGRAM

- Order in 2' increments based on available space
- Both a-la-carte and value pack options
- 2 stock colors available for quick ship
- Freestanding! Won't damage walls like wall systems will
- Easy to Set Up and Lightweight

QUICK SHIPMENT

- You and your customer can get a cohesive, custom-looking program in 2 weeks!
- Most components are UPS shippable
- Warehousing & Shipment. Don't have the space—no worries Tusco can warehouse and ship direct to your customer!

CUSTOMIZABLE

- Tusco Display can have custom signage printed—you supply the artwork
- Want a more customized solution? Tusco Display can design unique, custom fixtures exclusively for you
- Bring the entire micromarket together with cooler surrounds and lighting options
- Want to use your brand? Tusco Display can incorporate it into the overall micro market design

FREESTANDING 2' DISPLAYS



↪ *Extended*

Standard ↪

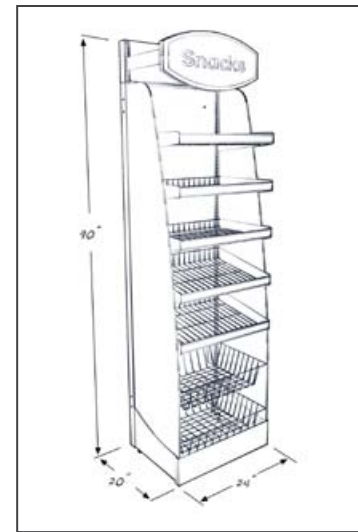

Extended

90" high X 20" deep x 24" wide

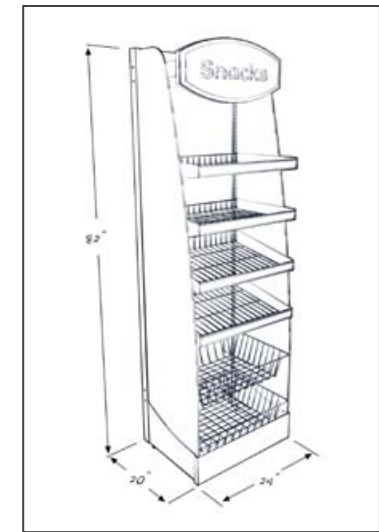

Standard

82" high X 20" deep x 24" wide

- Both versions have options for either slat wall or pegboard back wall
- Both options include:
 - 4 shelves
 - 2 baskets
 - 18 peg hooks

FREESTANDING 4' DISPLAYS



↪ *Extended*

Standard ↪

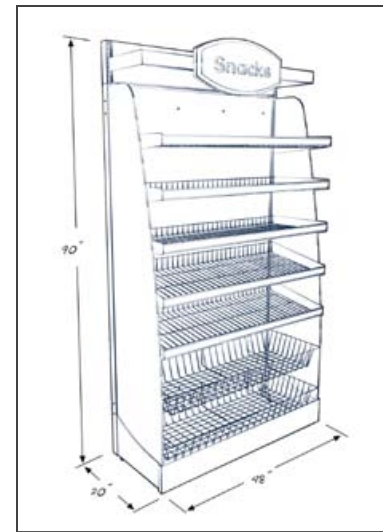

Extended

90" high X 20" deep x 48" wide

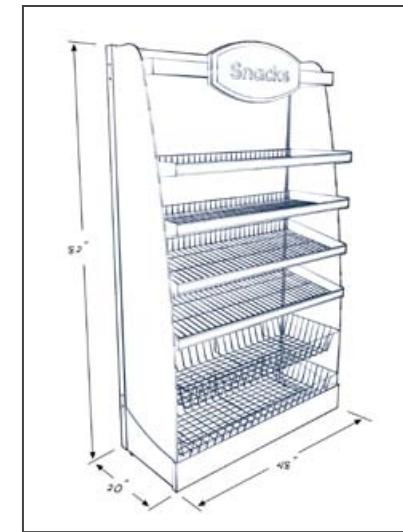

Standard

82" high X 20" deep x 48" wide

- Both versions have options for either slat wall or pegboard back wall
- Both options include:
 - 4 shelves
 - 2 baskets
 - 18 peg hooks

COFFEE CENTER



Option for ceiling hung signage

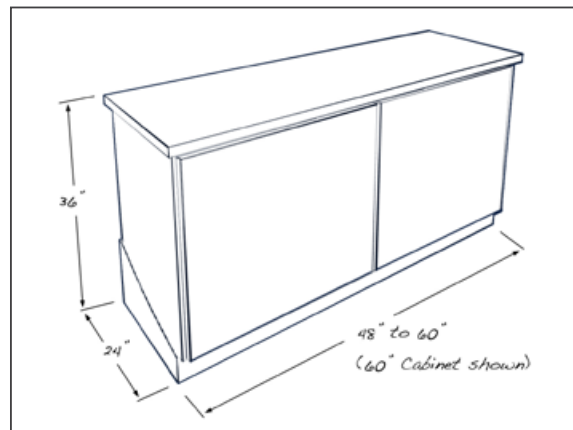

- Two Width options: 48" 60"
- Both versions are 24" deep and 36" tall
- Signage is an option



CHECK OUT CENTER

Dimensions

82" high X 20" deep x 24" wide

SIGNAGE OPTIONS

- Ceiling Hung
- Magnetic



A LA CARTE OPTIONS

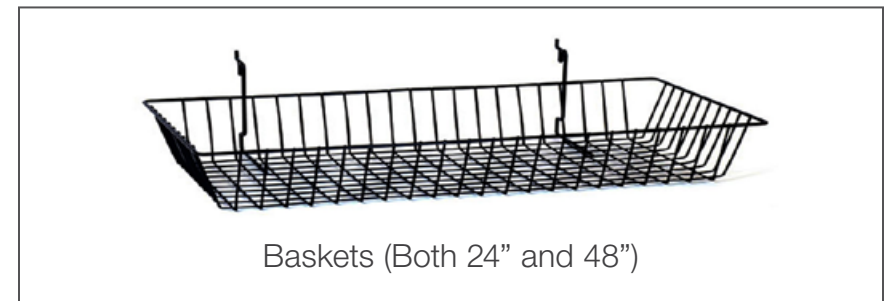
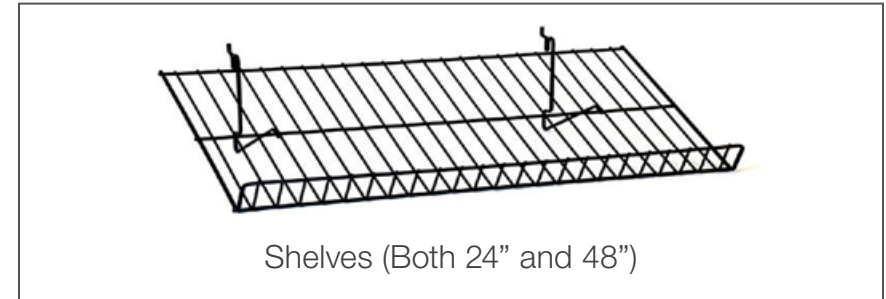

READY FOR A MORE CUSTOMIZED LOOK



- Cooler surrounds
- Custom color options
- Lighting
- Custom display fixtures



READY TO MOVE FORWARD?

CONTACT: Juliana Pfeifer
Retail Marketing Consultant

PHONE: (330) 260-9632

EMAIL: jpfeifer@tuscodisplay.com