

COMMANDER Omni Fiberglass Antenna, 470-482, 7.1dBi, N Female

 Please visit us on the internet at <http://www.commandertech.com>
Product Description

These fiberglass enclosed antennas offer significant advantages over most exposed element arrays and deliver equal or better electrical performance. Commander Omni Antennas employ multiple, large diameter copper radiating elements stacked collinearly, fed in phase and enclosed in a weather-proof fiberglass housing. These DC grounded units use low loss Teflon and insulated connectors. The antenna provides 5.0 dBd gain and can withstand winds of 100 mph (160 km/hr). It is excellent for duplex systems with 8 MHz or less separation between Tx and Rx frequencies. Several mounting hardware options are available for these antennas.



1150 Series

Features/Benefits

Weatherproof design assures system reliability, withstands winds of 100 mph. Copper elements minimize possibility of intermod generation. DC grounded - protects against damage from lightning strikes.

Technical Specifications

Frequency Band	300-699.9 MHz
Horizontal Pattern	Omni Directional
Antenna Type	Fiberglass Omni
Electrical Down Tilt Option	Fixed
Gain, dBi (dBd)	7.1 (5)
Frequency Range, MHz	470-482
Connector Type	N Female
Connector Location	Bottom
Mounting Type	Fixed
Electrical Down Tilt, deg	0
Orientation	Upright
Mounting Hardware	46 Clamp Set
Rated Wind Speed, km/h (mph)	160 (100)
Gain (Omni), dBi (dBd)	7.14 (5)
VSWR	< 1.6 : 1
Vertical Beamwidth, deg	18
Polarization	Vertical
Maximum Power Input, W	250
Lightning Protection	Direct Ground
3rd Order IMP @ 2 x 43 dBm, dBc	-130
Impedance, Ohms	50
Overall Length, m (ft)	9.01 (2.75)
Element Housing Length, m (ft)	8.01 (2.44)
Mounting Pipe Diameter, m (in)	0.06 (2.38)
Support Pipe Length, m (ft)	0.3 (1)
Weight, kg (lb)	8 (3.64)
Radiating Element Material	Copper
Element Housing Material	Fiberglass
Support Pipe Material	Aluminum Alloy
Max Wind Loading Area m ² (ft ²)	0.075 (.81)
Bend Mom @ Rated Wind 1" Below Top of Mt Pipe, N m (ft lbf)	147.7 (200.3)
Wind Load - Side @ Rated Wind, N (lbf)	143.3 (32.2)
Shipping Weight, kg (lb)	11.4 (25)
Packing Dimensions, HxWxD mm (in)	3200x 100 x 100 (126 x 3.94 x 3.94)
Packing Dimensions, HxWxD, m (ft)	3.2 x 0.1 x 0.1 (10.5 x 0.33 x 0.33)
Shipping Dimensions of Accessory, HxWxD, m (ft)	Packed with Antenna
Shipping Mode	Common Carrier

Notes

All information contained in this datasheet is subject to confirmation at time of ordering

Please visit us on the internet at <http://www.commandertech.com>

Other Documentation

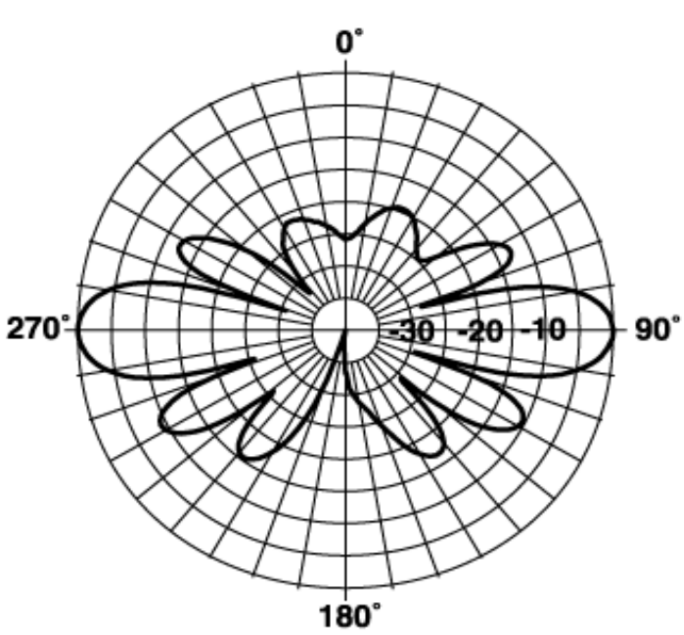

Vertical Pattern

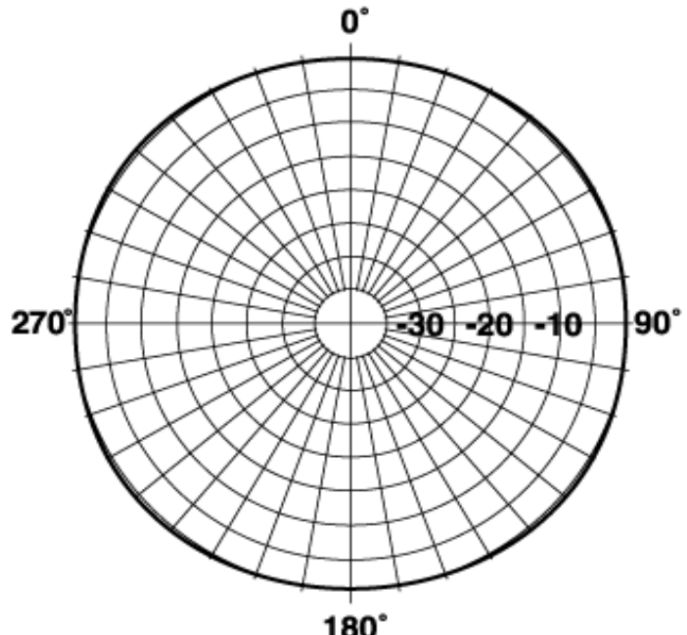

Horizontal Pattern

All information contained in this datasheet is subject to confirmation at time of ordering