

Commander Omni Fiberglass Antenna, 806-869, 12.1 dBi, N Female

 Please visit us on the internet at <http://www.commandertech.com>
Product Description

These AO8410M series of 10 DBd gain Omnidirectional Broadband Antennas is the latest in a proud lineage of Super StationMaster antennas. They cover the entire frequency range of 806 to 866 MHz, 824 to 894 MHz or 890 to 960 MHz, allowing for duplex operations of ESMR or cellular base stations on a single, high gain antenna. They are also available with electrical tilt options for better signal control. This design features universal mounting and the triple-wrapped, heavy-duty fiberglass construction protects the radiating elements from environmental hazards to survive maximum wind speeds of 230 mph. The antenna terminates with a Type N Female 50 Ohm connector, with power input of 500 Watts. A heavy duty 46 clamp set is supplied for vertically mounting the antenna to tower support.

Features/Benefits

-Triple-wrapped heavy duty fiberglass construction - Survives 230 mph wind speeds. Less tip deflection - much stronger than pultruded radomes used by competitors. Available with electrical tilt - allows better signal control. Broadband - reduces the need for multiple antennas. Conter-fed design eliminates beamswing across the band.

Technical Specifications

Frequency Band	806-869 MHz
Horizontal Pattern	Omni Directional
Antenna Type	Fiberglass Omni
Electrical Down Tilt Option	Fixed
Gain, dBi (dBd)	12.1 (10)
Frequency Range, MHz	806-869
Connector Type	N Female
Connector Location	Bottom
Mounting Type	Fixed
Electrical Down Tilt, deg	0
Orientation	Upright
Mounting Hardware	46 Clamp Set
Rated Wind Speed, km/h (mph)	322 (200)
Gain (Omni), dBi (dBd)	12.14 (10)
VSWR	< 1.5 : 1
Vertical Beamwidth, deg	5.5
Polarization	Vertical
Maximum Power Input, W	500
Lightning Protection	Direct Ground
Flexible Extension	Optional
Impedance, Ohms	50
Overall Length, m (ft)	4.72 (15.5)
Element Housing Length, m (ft)	4.11 (13.5)
Mounting Pipe Diameter, m (in)	0.07 (2.75)
Support Pipe Length, m (ft)	0.61 (2)
Weight, kg (lb)	12 (26)
Radiating Element Material	Copper
Element Housing Material	Fiberglass
Support Pipe Material	6061-T6 Aluminum
Max Wind Loading Area m ² (ft ²)	0.159 (1.71)
Survival Wind Speed, km/h (mph)	322 (200)
Bend Mom @ Rated Wind 1" Below Pop of Mt Pipe, N m (ft lbf)	2505 (1847)
Wind Load - Side @ Rated Wind, N (lbf)	1218 (274)
Shipping Weight, kg (lb)	18.6 (41)
Packing Dimensions, HxWxD mm (in)	5461 x 88.9 x 88.9 (215 x 3.5 x 3.5)
Packing Dimensions, HxWxD, m (ft)	5.46 x 0.89 x 0.89 (17.9 x 0.29 x 0.29)
Shipping Dimensions of Accessory - HxWxD, m (ft)	Packed w/antenna
Shipping Mode	Common Carrier

Notes

Commander Omni Fiberglass Antenna, 806-869, 12.1 dBi, N Female

Please visit us on the internet at <http://www.commandertech.com>

Other Documentation

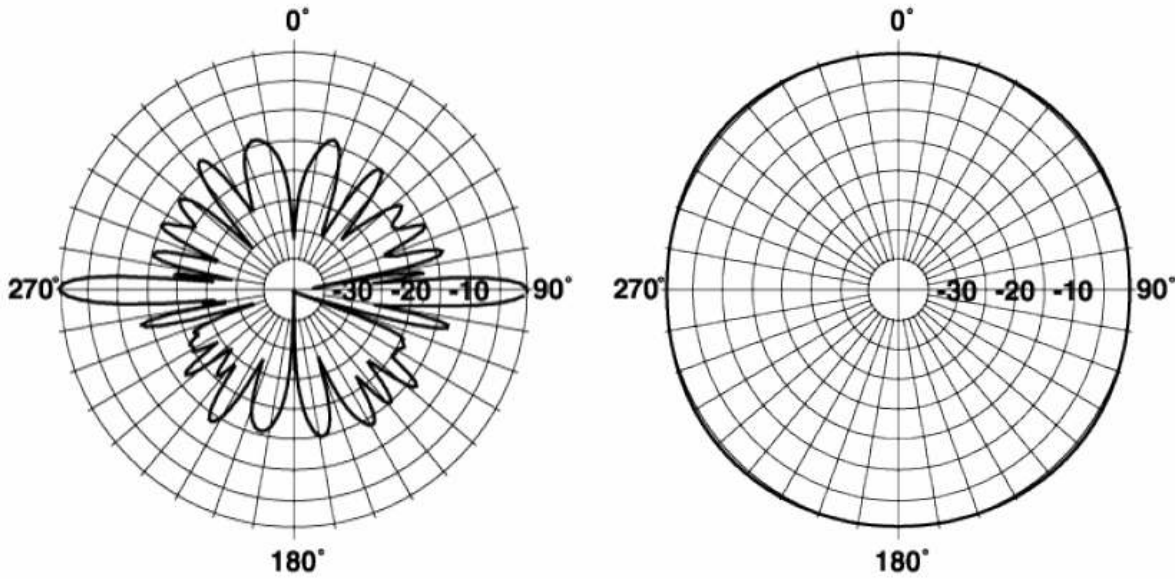

All information contained in this datasheet is subject to confirmation at time of ordering